

visual engineering
LIGHTWARE

User's Manual

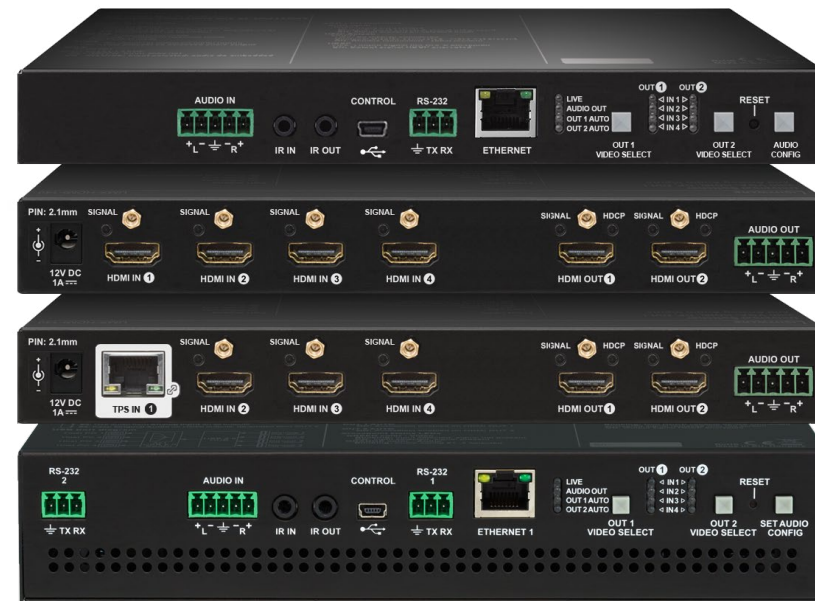

MMX4x2-HDMI
MMX4x2-HT200
MMX4x2-HDMI-USB20-L

Standalone Multimedia Matrix Switcher

Important Safety Instructions

Class II apparatus construction.

The equipment should be operated only from the power source indicated on the product.

To disconnect the equipment safely from power, remove the power cord from the rear of the equipment, or from the power source. The MAINS plug is used as the disconnect device, the disconnect device shall remain readily operable.

There are no user-serviceable parts inside of the unit. Removal of the cover will expose dangerous voltages. To avoid personal injury, do not remove the cover. Do not operate the unit without the cover installed.

The appliance must be safely connected to multimedia systems. Follow instructions described in this manual.

Ventilation

For the correct ventilation and to avoid overheating ensure enough free space around the appliance. Do not cover the appliance, let the ventilation holes free and never block or bypass the ventilators (if any).

WARNING

To prevent injury, the apparatus is recommended to securely attach to the floor/wall or mount in accordance with the installation instructions. The apparatus shall not be exposed to dripping or splashing and that no objects filled with liquids, such as vases, shall be placed on the apparatus. No naked flame sources, such as lighted candles, should be placed on the apparatus.

Waste Electrical & Electronic Equipment WEEE

This marking shown on the product or its literature, indicates that it should not be disposed with other household wastes at the end of its working life. To prevent possible harm to the environment or human health from uncontrolled waste disposal, please separate this from other types of wastes and recycle it responsibly to promote the sustainable reuse of material resources. Household users should contact either the retailer where they purchased this product, or their local government office, for details of where and how they can take this item for environmentally safe recycling. Business users should contact their supplier and check the terms and conditions of the purchase contract. This product should not be mixed with other commercial wastes for disposal.

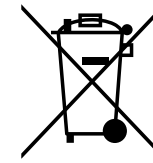

Common Safety Symbols

Symbol	Description
	Direct current
	Alternating current
	Double insulation
	Caution, possibility of electric shock
	Caution

Symbol Legend

The following symbols and markings are used in the document:

WARNING! Safety-related information which is highly recommended to read and keep in every case!

ATTENTION! Useful information to perform a successful procedure; it is recommended to read.

DIFFERENCE: Feature or function that is available with a specific firmware/hardware version or product variant.

INFO: A notice which may contain additional information. Procedure can be successful without reading it.

DEFINITION: The short description of a feature or a function.

TIPS AND TRICKS: Ideas which you may have not known yet but can be useful.

Navigation Buttons

 Go back to the previous page. If you clicked on a link previously, you can go back to the source page by pressing the button.

 Navigate to the Table of Contents.

 Step back one page.

 Step forward to the next page.

Document Information

All presented functions refer to the indicated products. The descriptions have been made during testing these functions in accordance with the indicated Hardware/Firmware/Software environment:

Item	Version
Lightware Device Controller (LDC) software	2.3.0b1
Lightware Device Updater V2 (LDU2) software	2.3.0b1
Firmware package	1.5.0b8
Hardware - MMX4x2-HDMI	1.1
Hardware - MMX4x2-HT200	1.2
Hardware - MMX4x2-HDMI-USB20-L	1.1

Document revision: **v3.0**

Release date: **16-07-2020**

Editor: Laszlo Zsedenyi

About Printing

Lightware Visual Engineering supports green technologies and Eco-friendly mentality. Thus, this document is made for digital usage primarily. If you need to print out a few pages for any reason, follow the recommended printing settings:

- Page size: A4
- Output size: Fit to page or Match page size
- Orientation: Landscape

TIPS AND TRICKS: Thanks to the size of the original page, a border around the content (gray on the second picture below) makes possible to organize the pages better. After punching the printed pages, they can be placed easily into a ring folder.

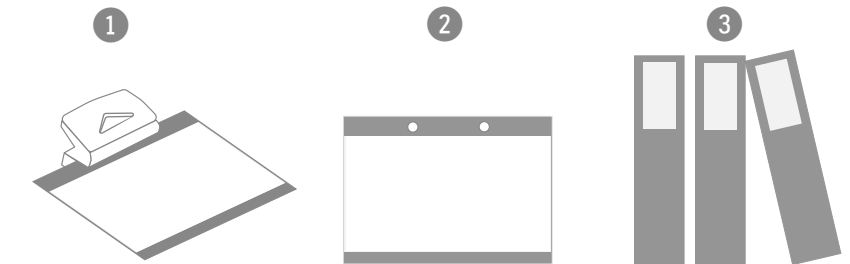

Hashtag (#) Keywords in the Document

This user's manual contains keywords with hashtag (#) to help you to find the relevant information as quick as possible.

The format of the keywords is the following:

#<keyword>

The usage of the keywords: use the **Search** function (Ctrl+F / Cmd+F) of your PDF reader application, type the # (hashtag) character and the wished keyword.

The **#new** special keyword indicates a new feature/function that has just appeared in the latest firmware or software version.

Example

#dhcp

This keyword is placed at the DHCP setting command in the LW3 Programmer's reference section.

Table of Contents

1. INTRODUCTION	7	4.4. AUDIO INTERFACE	25	5.9. CONTROL MENU	47
1.1. DESCRIPTION	8	4.4.1. Audio Input Modes	25	5.9.1. RS-232.....	47
1.2. COMPATIBLE DEVICES	8	4.4.2. Audio Output Modes	25	5.9.2. Ethernet.....	48
1.3. BOX CONTENTS	8	4.4.3. Audio Options - Example.....	25	5.9.3. GPIO	48
1.4. OPTIONAL ACCESSORIES	9	4.5. THE AUTOSELECT FEATURE	26	5.9.4. Infra	49
1.5. TYPICAL APPLICATIONS	9	4.6. USB INTERFACE	27	5.9.5. USBSwitch.....	50
1.6. FEATURES	10	4.6.1. USB Control Interface.....	27	5.10. EVENT MANAGER	51
1.6.1. MMX4x2-HDMI-USB20-L Features.....	10	4.6.2. 4x1 USB 2.0 Switch	27	5.10.1. The Event Editor	51
2. PRODUCT OVERVIEW	11	4.7. ETHERNET INTERFACE	27	5.10.2. Create or Modify an Event	52
2.1. MMX4x2-HT200	12	4.8. TPS INTERFACE	28	5.10.3. Special Tools and Accessories	52
2.2. MMX4x2-HDMI	13	4.9. RS-232 SERIAL INTERFACE	28	5.10.4. Clear One or More Event(s).....	53
2.3. MMX4x2-HDMI-USB20-L	14	4.9.1. Technical Background.....	28	5.10.5. Export and Import Events	53
2.4. FRONT PANEL LEDs	15	4.9.2. RS-232 Recognizer	29	5.10.6. Event Creating - Example.....	53
2.5. REAR PANEL LEDs	15	4.10. IR INTERFACE	30	5.11. SETTINGS MENU	54
2.6. FRONT PANEL BUTTONS	16	4.11. GPIO INTERFACE	31	5.11.1. Status	54
2.6.1. OUT 1 and OUT 2 Video Select Buttons.....	16	4.12. FURTHER BUILT-IN FEATURES	31	5.11.2. Network.....	54
2.6.2. Set Audio Config Button.....	16	4.12.1. Automatically Launched Actions – The Event Manager.....	31	5.11.3. Backup	54
2.6.3. Enable DHCP (Static) IP Address	17	4.12.2. Matrix Cloning – Configuration Backup and Restore	31	5.11.4. System	55
2.6.4. Reset to Factory Default Settings.....	17	4.12.3. Advanced EDID Management.....	31	5.12. THE BUILT-IN MINIWEB	56
2.6.5. Resetting the Device.....	17	5. SOFTWARE CONTROL - LIGHTWARE DEVICE CONTROLLER	33	5.12.1. Opening the Miniweb	56
2.6.6. Control Lock.....	17	5.1. INSTALL AND UPGRADE	33	5.12.2. The Default Status Page.....	57
2.6.7. Entering Firmware Upgrade Mode.....	17	5.2. RUNNING THE LDC	34	5.12.3. Miniweb Customization	57
3. INSTALLATION	18	5.3. ESTABLISHING THE CONNECTION	34	5.13. CONFIGURATION CLONING (BACKUP TAB)	58
3.1. MOUNTING OPTIONS	19	5.4. CROSSPOINT MENU	36	5.13.1. Cloning Steps in a Nutshell.....	58
3.1.1. 1U High Rack Shelf.....	19	5.4.2. Presets Tab	37	5.13.2. Save the Settings of the Device (Backup).....	58
3.1.2. Under-desk Double Mounting Kit.....	19	5.4.3. Port Tiles.....	37	5.13.3. Upload the Settings to a Device (Restore).....	58
3.1.3. Rack Ear-mounting	19	5.5. PORT PROPERTIES WINDOWS	38	5.13.4. Create and Restore Backups from the Device Memory.....	59
3.2. ELECTRICAL CONNECTIONS	20	5.5.1. TPS Video Input.....	38	5.14. ADVANCED VIEW WINDOW	59
3.2.1. 12V DC Connection	20	5.5.2. HDMI Video Input	38	6. LW2 PROGRAMMERS' REFERENCE	60
3.2.2. HDMI Connector	20	5.5.3. HDMI Video Output	39	6.1. PROTOCOL DESCRIPTION	60
3.2.3. Analog Audio Input and Output	20	5.5.4. Digital Audio Input	40	6.2. INSTRUCTIONS FOR THE TERMINAL APPLICATION USAGE	61
3.2.4. RJ45 Connectors (TPS and Ethernet Ports).....	20	5.5.5. Analog Audio Input.....	40	6.3. GENERAL LW2 COMMANDS	61
3.2.5. USB Connectors	20	5.5.6. Digital Audio Output	41	6.3.1. View Product Type.....	61
3.2.6. IR Connector	21	5.5.7. Analog Audio Output.....	41	6.3.2. Query Control Protocol.....	61
3.2.7. RS-232 Connector	21	5.6. CEC TOOL	42	6.3.3. View Firmware Version of the CPU	61
3.2.8. GPIO - General Purpose Input/Output Ports.....	21	5.7. DIAGNOSTIC TOOLS	43	6.3.4. Connection Test.....	62
3.3. CONNECTING STEPS	22	5.7.1. Frame Detector	43	6.3.5. View Serial Number.....	62
4. DEVICE CONCEPT	23	5.7.2. No Sync Screen (Test Pattern)	43	6.3.6. Compile Time.....	62
4.1. COMPACT SIZE MATRIX CONCEPT	24	5.7.3. Cable Diagnostics	44	6.3.7. View Installed Board	62
4.2. VIDEO INTERFACE	24	5.8. EDID MENU	45	6.3.8. View Firmware for All Controllers.....	62
4.3. CONSUMING ELECTRONICS CONTROL (CEC) INTERFACE	25	5.8.1. EDID Operations	45	6.3.9. Restart the Device	62
		5.8.2. EDID Summary Window	46	6.3.10. Query Health Status	63
		5.8.3. Editing an EDID	46	6.3.11. Restore Factory Default Settings	63
		5.8.4. Creating an EDID - Easy EDID Creator	47		

6.4. A/V PORT SETTINGS.....	63	7.5.3. Querying the Video Crosspoint Setting.....	75	7.7.5. Mute/Unmute Analog Audio Output.....	86
6.4.1. Switch an Input to the Outputs.....	63	7.5.4. Switching Video Input.....	75	7.7.6. Analog Audio Input Level Settings by Exact Values.....	87
6.4.2. Mute Output.....	64	7.5.5. Querying the Video Autoselect Settings.....	75	7.7.7. Analog Audio Input Level Settings by Steps.....	88
6.4.3. Unmute Output.....	64	7.5.6. Changing the Autoselect Mode.....	75	7.7.8. Analog Audio Output Level Settings.....	88
6.4.4. Lock Output.....	64	7.5.7. Querying the Input Port Priority.....	76	7.7.9. Analog Audio Output Level Settings by Steps.....	89
6.4.5. Unlock Output.....	64	7.5.8. Changing the Input Port Priority.....	76	7.8. ETHERNET PORT CONFIGURATION.....	90
6.4.6. View Connection State on the Output.....	64	7.5.9. Mute an Input Port.....	76	7.8.1. Set the DHCP State.....	90
6.4.7. View Crosspoint Size.....	65	7.5.10. Unmute an Input Port.....	76	7.8.2. Change the IP Address (Static).....	90
6.4.8. Change the Video Autoselect Mode.....	65	7.5.11. Lock an Input Port.....	77	7.8.3. Change the Subnet Mask (Static).....	90
6.4.9. Change the Audio Autoselect Mode.....	65	7.5.12. Unlock an Input Port.....	77	7.8.4. Change the Gateway Address (Static).....	90
6.4.10. Change the Video Input Priorities.....	65	7.5.13. Mute an Output Port.....	77	7.8.5. Apply Network Settings.....	90
6.4.11. Change the Audio Input Priorities.....	66	7.5.14. Unmute an Output Port.....	77	7.9. ETHERNET MESSAGE SENDING.....	91
6.5. NETWORK CONFIGURATION.....	66	7.5.15. Lock an Output Port.....	77	7.9.1. Sending a TCP Message (ASCII-format).....	91
6.5.1. Query the Current IP Status.....	66	7.5.16. Unlock an Output Port.....	77	7.9.2. Sending a TCP Text (ASCII-format).....	91
6.5.2. Set the IP Address.....	66	7.5.17. HDCP Setting (Input Port).....	77	7.9.3. Sending a TCP Binary Message (HEX-format).....	91
6.5.3. Set the Subnet Mask.....	67	7.5.18. HDCP Setting (Output Port).....	78	7.9.4. Sending a UDP Message (ASCII-format).....	91
6.5.4. Set the Gateway Address.....	67	7.5.19. Test Pattern Generator.....	78	7.9.5. Sending a UDP Text (ASCII-format).....	92
6.5.5. Apply Network Settings.....	67	7.5.20. HDMI Mode Settings (Output Port).....	79	7.9.6. Sending a UDP Binary Message (HEX-format).....	92
6.6. GPIO PORT CONFIGURATION.....	67	7.5.21. Querying the Recent TPS Mode.....	79	7.10. RS-232 PORT CONFIGURATION.....	93
6.6.1. Setting the Level and Direction for Each Pins.....	67	7.5.22. TPS Mode Settings.....	79	7.10.1. Protocol Setting.....	93
6.7. LW2 COMMANDS – QUICK SUMMARY.....	68	7.6. AUDIO PORT SETTINGS FRM FIRMWARE V1.2.0.....	80	7.10.2. BAUD Rate Setting.....	93
7. LW3 PROGRAMMERS' REFERENCE.....	69	7.6.1. Querying the Status of Source Port.....	80	7.10.3. Databit Setting.....	93
7.1. OVERVIEW.....	70	7.6.2. Querying the Status of Destination Port.....	81	7.10.4. Stopbits Setting.....	93
7.2. INSTRUCTIONS FOR THE TERMINAL APPLICATION USAGE.....	70	7.6.3. Querying the Audio Crosspoint State.....	81	7.10.5. Parity Setting.....	94
7.3. PROTOCOL RULES.....	70	7.6.4. Switching Audio Input.....	81	7.10.6. RS-232 Operation Mode.....	94
7.3.1. LW3 Tree Structure and Command Structure (examples).....	70	7.6.5. Querying the Audio Autoselect Settings.....	81	7.10.7. Enable Command Injection.....	94
7.3.2. General Rules.....	70	7.6.6. Changing the Autoselect Mode.....	82	7.11. RS-232 MESSAGE SENDING.....	95
7.3.3. Legend for the Control Commands.....	71	7.6.7. Querying the Input Port Priority.....	82	7.11.1. Sending a Message (ASCII-format) via RS-232.....	95
7.3.4. Command Types.....	71	7.6.8. Changing the Input Port Priority.....	82	7.11.2. Sending a Text (ASCII-format) via RS-232.....	95
7.3.5. Prefix Summary.....	71	7.6.9. Mute an Audio Input.....	82	7.11.3. Sending a Binary Message (HEX-format) via RS-232.....	95
7.3.6. Error Messages.....	71	7.6.10. Unmute an Audio Input.....	83	7.11.4. Using Hexadecimal Codes.....	95
7.3.7. Escaping.....	72	7.6.11. Lock an Input Port.....	83	7.12. RS-232 MESSAGE RECOGNIZER.....	96
7.3.8. Signature.....	72	7.6.12. Unlock an Input Port.....	83	7.12.1. Enable the Recognizer.....	96
7.3.9. Subscription.....	72	7.6.13. Mute an Audio Output Port.....	83	7.12.2. Set the Delimiter Hex.....	96
7.3.10. Notifications about the Changes of the Properties.....	72	7.6.14. Unmute an Audio Output Port.....	83	7.12.3. Set the Timeout.....	96
7.4. SYSTEM COMMANDS.....	73	7.6.15. Lock an Audio Output Port.....	84	7.12.4. Query the Last Recognized Message.....	96
7.4.1. Setting the Device Label.....	73	7.6.16. Unlock an Audio Output Port.....	84	7.12.5. Clear the Stored Last Recognized Serial Message.....	97
7.4.2. Resetting the Device.....	73	7.6.17. Analog Audio Input Gain Setting.....	84	7.12.6. Query the Last Recognized Active Message.....	97
7.4.3. Restore the Factory Default Settings.....	73	7.6.18. Analog Audio Output Level Settings by Exact Values.....	84	7.12.7. Set the Active Timeout.....	97
7.4.4. Querying the Firmware Version.....	73	7.6.19. Analog Audio Output Level Settings by Steps.....	85	7.13. CEC COMMAND SENDING.....	98
7.4.5. Control Lock.....	73	7.7. AUDIO PORT SETTINGS FOR FIRMWARE V1.1.0.....	85	7.13.1. Sending an OSD String.....	98
7.4.6. Identify the Device.....	73	7.7.1. Set Audio Source of HDMI Output 1.....	85	7.13.2. Sending a CEC Command in Text Format.....	98
7.5. VIDEO PORT SETTINGS.....	74	7.7.2. Set Audio Source of HDMI Output 2.....	86	7.13.3. Send CEC Command in Hexadecimal Format.....	98
7.5.1. Querying the Status of the Input Ports.....	74	7.7.3. Set Audio Source of Analog Audio Output.....	86	7.13.4. Querying the Last Received CEC Message.....	99
7.5.2. Querying the Status of the Output Ports.....	75	7.7.4. Mute/Unmute Analog Audio Input.....	86		

7.14. INFRARED PORT CONFIGURATION	99	10. TECHNOLOGIES	120
7.14.1. Enable Command Injection Mode.....	99	10.1. EDID MANAGEMENT	121
7.14.2. Change Command Injection Port Number	99	10.1.1. Understanding the EDID.....	121
7.14.3. Enable/Disable Output Signal Modulation.....	99	10.1.2. Advanced EDID Management.....	121
7.15. INFRARED MESSAGE SENDING	100	10.2. HDCP MANAGEMENT	122
7.15.1. Sending Pronto Hex Codes in Little-endian Format via IR Port	100	10.2.1. Protected and Unprotected Content	122
7.15.2. Sending Pronto Hex Codes in Big-endian Format via IR Port...	100	10.2.2. Disable Unnecessary Encryption.....	122
7.16. GPIO PORT CONFIGURATION	101	10.3. PIXEL ACCURATE RECLOCKING	123
7.16.1. Querying the Direction of a GPIO Pin	101	11. APPENDIX	124
7.16.2. Setting the Direction of a GPIO Pin	101	11.1. SPECIFICATIONS	125
7.16.3. Querying the Output Level of a GPIO Pin	101	11.2. MAXIMUM EXTENSION DISTANCES	126
7.16.4. Setting the Output Level of a GPIO Pin	101	11.3. INPUT/OUTPUT PORT NUMBERING	126
7.16.5. Toggling the Level of a GPIO Pin.....	101	11.3.1. MMX4x2-HDMI and MMX4x2-HDMI-USB20-L.....	126
7.17. USB 2.0 SWITCH CONFIGURATION	102	11.3.2. MMX4x2-HT200	127
7.17.1. Setting the Active USB Host	102	11.4. CONTENT OF BACKUP FILE	127
7.17.2. Power Switch Delay.....	102	11.6. FACTORY DEFAULT SETTINGS	128
7.17.3. Querying the Host Presence.....	102	11.7. MECHANICAL DRAWINGS	129
7.17.4. Setting the 5V Sending to the USB Peripherals	102	11.7.1. 1/2 U High Devices.....	129
7.17.5. Querying the 5V Overcurrent State of a USB Peripheral	103	11.7.2. MMX4x2-HDMI-USB20-L.....	129
7.18. EDID MANAGEMENT	104	11.8. CABLE WIRING GUIDE	130
7.18.1. Query the Emulated EDIDs.....	104	11.8.1. Serial Ports	130
7.18.2. Query the Validity of a Dynamic EDID	104	11.8.2. Audio Ports	130
7.18.3. Query the Preferred Resolution of a User EDID	104	11.9. FACTORY EDID LIST	131
7.18.4. Emulating an EDID to an Input Port.....	104	11.10. FIRMWARE RELEASE NOTES	132
7.18.5. Emulating an EDID to All Input Ports	104	11.11. LW3 COMMAND CHANGES IN FIRMWARE v1.2.0	133
7.18.6. Copy an EDID to User Memory	105	11.12. HASHTAG KEYWORD LIST	134
7.18.7. Deleting an EDID from User Memory	105	11.13. FURTHER INFORMATION	135
7.18.8. Resetting the Emulated EDIDs.....	105		
7.19. LW3 COMMANDS - QUICK SUMMARY	106		
8. FIRMWARE UPGRADE	111		
8.1. INTRODUCTION	111		
8.2. PREPARATION	111		
8.2.1. About the Firmware Package (LFP2 File)	111		
8.2.2. LDU2 Installation	111		
8.3. RUNNING THE SOFTWARE	112		
8.4. THE UPGRADING STEPS	114		
8.5. IF THE UPGRADE IS NOT SUCCESSFUL	116		
9. TROUBLESHOOTING	117		
9.1. USE CASE STUDIES	117		
9.2. HOW TO SPEED UP THE TROUBLESHOOTING PROCESS	119		

1

Introduction

Thank you for choosing Lightware's MMX4x2 series device. In the first chapter we would like to introduce the device highlighting the most important features in the coming sections.

- ▶ DESCRIPTION
- ▶ COMPATIBLE DEVICES
- ▶ BOX CONTENTS
- ▶ OPTIONAL ACCESSORIES
- ▶ TYPICAL APPLICATIONS
- ▶ FEATURES

1.1. Description

MMX4x2 series device is a unique mini size matrix switcher. HT200 model has three HDMI inputs and one HDBaseT™ compatible TPS input port. It has two independent HDMI outputs. HDMI model has four HDMI inputs and two independent HDMI outputs. Audio can be de-embedded from the HDMI signal to a balanced 5-pole Phoenix (Euroblock) port and external audio signal can be embedded into the HDMI stream from another 5-pole Phoenix input port. The volume and gain properties of the audio signal can be modified at both input and output. The unit is fully 4K/UHD/3D capable and HDCP compliant. The device has built-in Event Manager tool configurable via the Lightware Device Controller software. Further control options are served by the USB, RS-232, IR (in and out) and Ethernet ports.

MMX4x2-HDMI-USB20-L Model *#new*

The model has four HDMI inputs and two independent HDMI outputs, as well as a USB 2.0 layer that provides the switching of four external USB peripherals (USB devices such as webcam, speakerphone, multitouch display, etc.) to four independent host computers or laptops.

Unique USB functions allow seamless integration in Unified Communication and small Video Conference rooms. The USB 'Host5vSense' function recognizes when a USB cable is connected and performs condition triggering for the Event Manager. For example, switch USB devices to the last connected USB laptop if configured accordingly. The 'Device5vEnable' turns ON or OFF peripherals' 5 Volt over the USB cable.



HDMI connectors are 4K capable and HDCP compliant and additional control options are served by the USB, RS-232, IR (in and out), Ethernet and GPIO ports.

Model Denomination

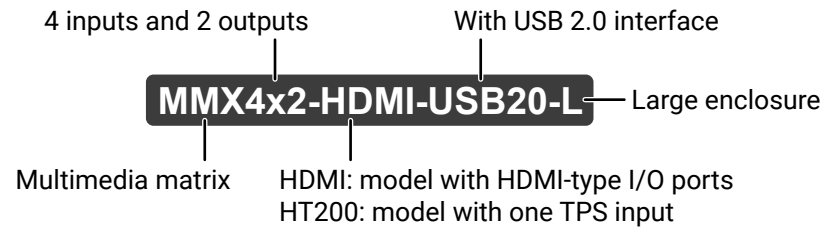

About the Serial Number

Lightware devices contain a label indicating the unique serial number of the product. The structure is the following:

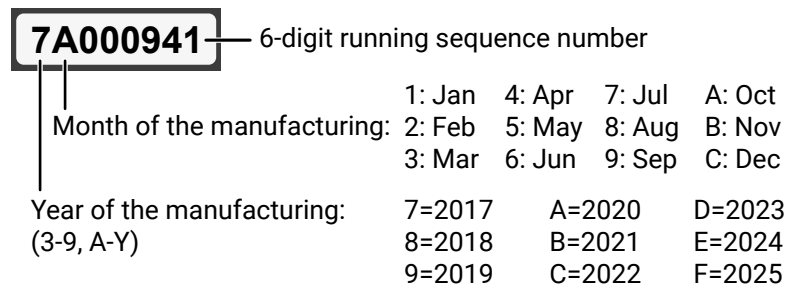

1.2. Compatible Devices







The MMX4x2-HT200 matrix is compatible with other Lightware TPS transmitters, matrix TPS and TPS2 boards, 25G TPS2 boards, as well as third-party HDBaseT-extenders, displays, but not compatible with the phased out TPS-90 extenders.

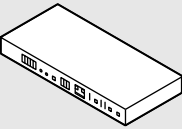
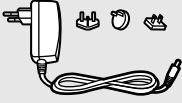

The MMX4x2-HT200 matrix is compatible with any third-party HDBaseT™ device.

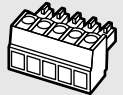
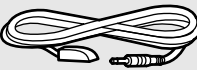
HDBaseT™ and the HDBaseT Alliance logo are trademarks of the HDBaseT Alliance.

1.3. Box Contents

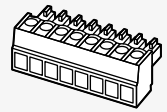
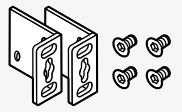
 MMX4x2 series matrix	 12V DC adaptor with interchangeable plugs	 Phoenix® Combicon 3-pole connector ¹	 Phoenix® Combicon 5-pole connector (2x)
 Infrared emitter unit	 Infrared detector unit	 UTP patch cable (3 m)	 Safety & warranty info, Quick Start Guide
 Phoenix® Combicon 8-pole connector ²	 Rack ears (2x) with M4x8 screws (4x) ²		

² Two pieces are supplied with MMX4x2-HDMI-USB20-L model

¹ Supplied with MMX4x2-HDMI-USB20-L model only.

1.4. Optional Accessories

The following not-supplied accessories can be purchased and used with the device; please contact sales@lightware.com. #new

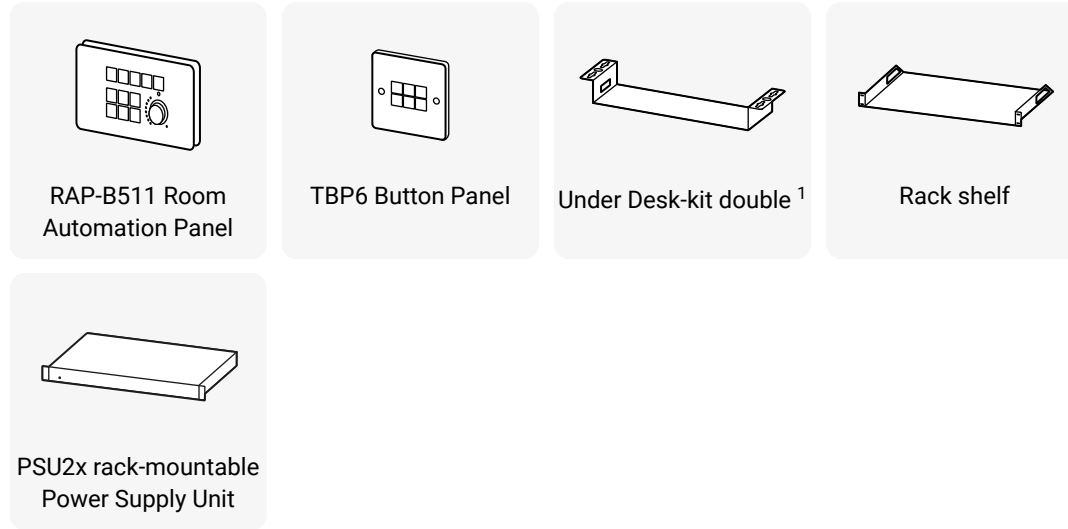

¹ Recommended for MMX4x2-HDMI and MMX4x2-HT200 models only.

The assembling of certain accessories can be found in the [Mounting Options](#) section.

1.5. Typical Applications

Standalone Application - MMX4x2-HDMI

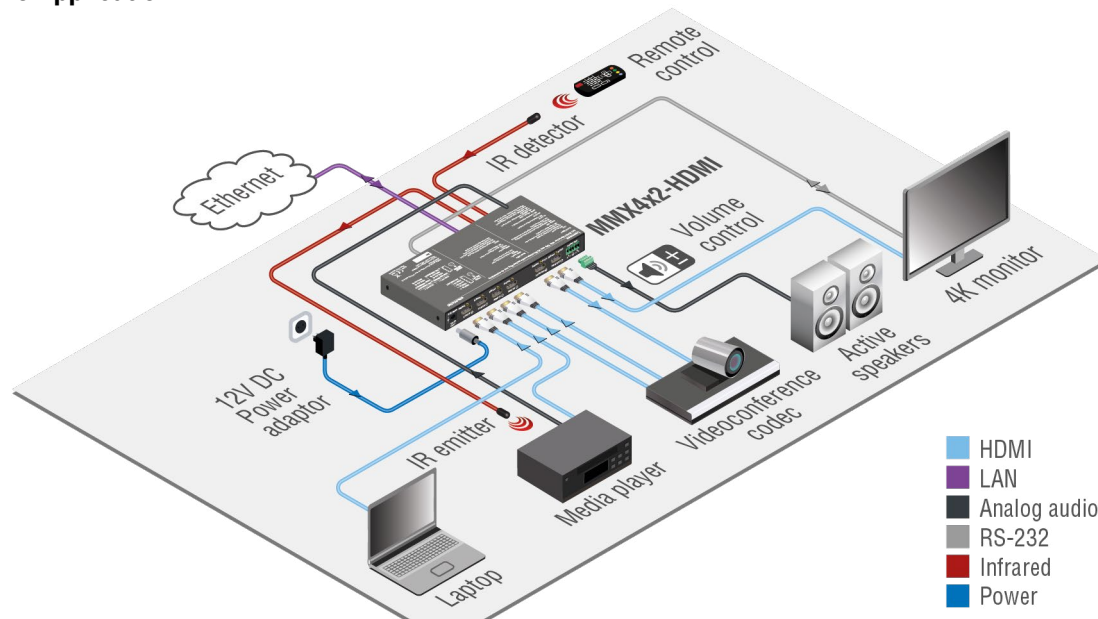

- HDMI
- LAN
- Analog audio
- RS-232
- Infrared
- Power

Standalone Application - MMX4x2-HT200

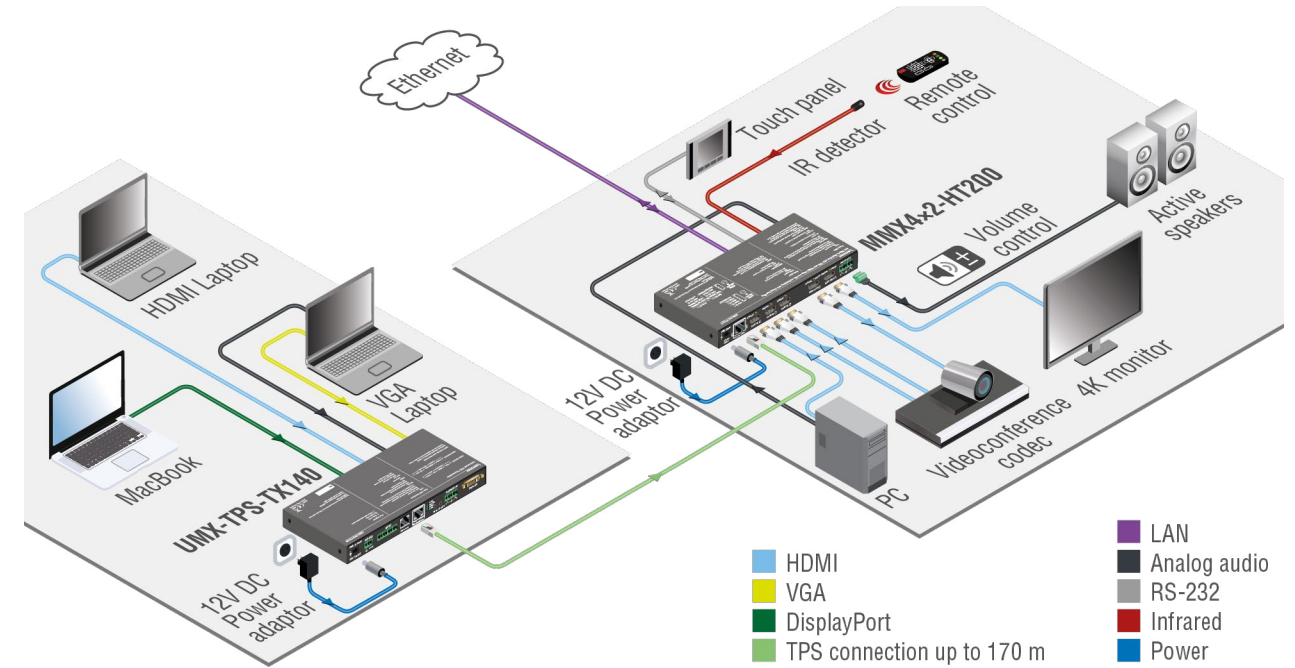

- HDMI
- VGA
- DisplayPort
- TPS connection up to 170 m
- LAN
- Analog audio
- RS-232
- Infrared
- Power

Standalone Application - MMX4x2-HDMI-USB20-L #new

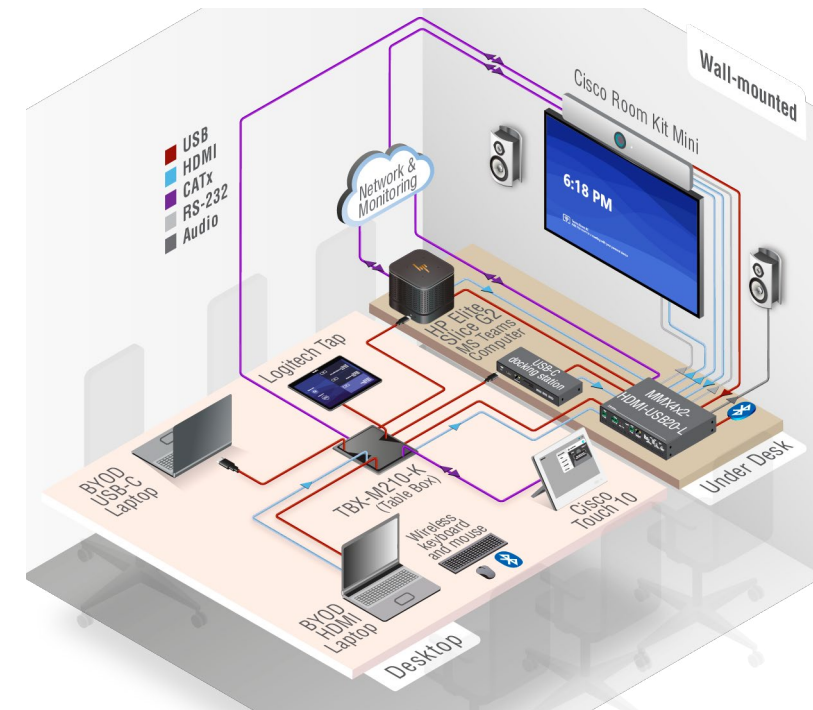

- USB
- HDMI
- CATx
- RS-232
- Audio

1.6. Features



3D and 4K Support

High bandwidth allows extension of resolutions up to 4K and even 3D sources and displays are supported.



Signal Transmission up to 170 m - Only for MMX4x2-HT200 model

Video and audio signal transmission (HDMI, Ethernet, RS-232, and Infrared over a single CAT5e... CAT7e cable.



Pixel Accurate Reclocking

Each output has a clean, jitter free signal, eliminating signal instability and distortion caused by long cables or connector reflections.



Frame Detector and Signal Analysis

The exact video and audio signal format can be determined such as timing, frequencies, scan mode, HDCP encryption, color range, color space and audio sample rate.



Autoselect Function for Video Inputs

The Autoselect feature can sense the port status on the video input ports and select automatically one of them. Priority number can be set for each input port and the feature allows to set various modes for the automatic input selection (First detect, Last detect, Priority mode).



Audio Embedder and De-embedder Function

The analog audio can be embedded to HDMI outputs and embedded audio can be routed to the analog audio output.



HDCP-compliant

The matrix fulfills the HDCP standard. HDCP capability on the digital video inputs can be disabled when non-protected content is extended.



Built-in Event Manager

The Event Manager tool takes care of all the necessary control in a smaller configuration by performing predefined actions in response to device status changes. Hence, in a less complex environment, there is no need to invest in additional control solutions, which makes the receiver the best choice for numerous applications.



Bi-directional RS-232 Interface

AV systems can also contain serial port controllers and controlled devices. Serial port supports any unit that works with standard RS-232.

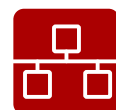

Ethernet Control

Multiple simultaneous TCP/IP connections are available with a simple ASCII-based protocol for controlling, configuring the receiver or perform a firmware upgrade.



Forced Button Lock

The front panel buttons can be locked and unlock is only possible via LW3 protocol command.



Built-in Mini Web

The Miniweb is able to display an adaptive surface with a virtual crosspoint and buttons for Event manager Actions.



CEC Support

Supporting standard CEC commands in order to remote control the source or sink device over HDMI cable.



IR Code Sending

IR code sending in Pronto Hex format – in Command injection mode, too. The code sending is available as an Action in Event manager, too.



RS-232 Recognizer

Supports recognizing the incoming RS-232 messages to integrate with 3rd party devices e.g. Video Codec.

1.6.1. MMX4x2-HDMI-USB20-L Features

DIFFERENCE: The following features refer to the MMX4x2-HDMI-USB20-L model only. *#new*



4x1 USB 2.0 Switch

The USB 2.0 layer provides the switching of four external USB peripherals (e.g. webcam, speakerphone, multitouch display, etc.) to four independent host computers or laptops.



GPIO Control Port

Six GPIO pins operating at TTL digital signal levels and can be controlled with both LW2 and LW3 commands. 5V is supplied over the 7th pin constantly, up to 500 mA.

2

Product Overview

The following sections are about the physical structure of the device, input/output ports and connectors, buttons and status LEDs.

- ▶ [MMX4x2-HT200](#)
- ▶ [MMX4x2-HDMI](#)
- ▶ [MMX4x2-HDMI-USB20-L](#)
- ▶ [FRONT PANEL LEDs](#)
- ▶ [REAR PANEL LEDs](#)
- ▶ [FRONT PANEL BUTTONS](#)

2.1. MMX4x2-HT200

Front View

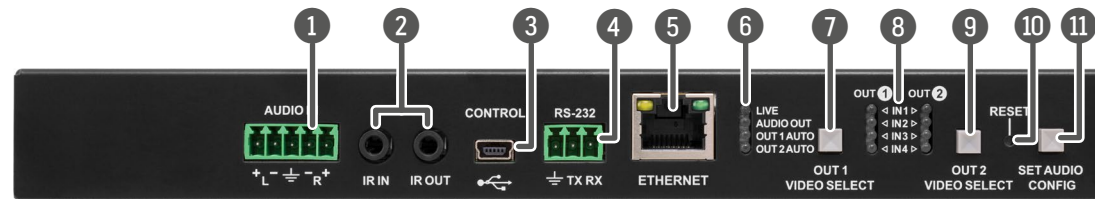

- 1 **Audio input port** 5-pole Phoenix connector for balanced analog audio. Pin assignment can be found in the [Analog Audio Input and Output](#) section.
- 2 **IR IN and OUT** 3-pole TRS connector, also known as 3.5 mm (1/8") jack plug for optional IR receiver (IR IN) and transmitter (IR OUT). Pin assignments can be found in the [IR Connector](#) section.
- 3 **USB** USB interface for LDC connection to control the matrix.
- 4 **RS-232** 3-pole Phoenix connector for controlling the device with LDC, third-party control systems, or third-party device control. Pin assignment can be found in the [RS-232 Connector](#) section.
- 5 **Ethernet** Locking RJ45 connector for device control and firmware upgrade.
- 6 **Status LEDs** The LEDs give immediate feedback about current state of the device. See the details in the [Front Panel LEDs](#) section.
- 7 **Video select button for Output 1** Pushing the button selects video source for Output 1. See the sequence in the [OUT 1 and OUT 2 Video Select Buttons](#) section.
- 8 **Input select LEDs** The LEDs give feedback about the current crosspoint settings.
- 9 **Video select button for Output 2** Pushing the button selects video source for Output 2. See the sequence in the [OUT 1 and OUT 2 Video Select Buttons](#) section.
- 10 **Reset button** Pressing reset button reboots the device. It results the same as unplugging and re-plugging the power connector.
- 11 **Set Audio Config button** Audio configuration and special functions are available through this button. See more information about the audio configuration modes in the [Set Audio Config Button](#) section and the special functions in the [Enable DHCP \(Static\) IP Address](#) section.

Rear View



- 1 **12V DC 1A input port** Local power in; connect the output of the supplied 12V DC power adaptor. For more details see the next section.
- 2 **TPS input port** Locking RJ45 connector. Connect a twisted pair cable between the transmitter and the matrix. Maximum cable extension distances can be found in the [Mechanical Drawings](#) section.
- 3 **HDMI input ports** HDMI input ports for sources. LED operation can be found in the [Rear Panel LEDs](#) section.
- 4 **HDMI output ports** Connect an HDMI cable between the sink device and the matrix. LED operations can be found in the [Rear Panel LEDs](#) sections.
- 5 **Audio output port** 5-pole Phoenix connector for balanced analog audio output. Pin assignment can be found in the [Analog Audio Input and Output](#) section.

2.2. MMX4x2-HDMI

Front View

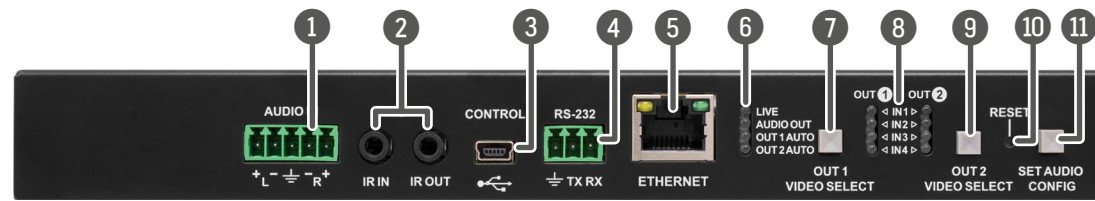

- | | | |
|---|---|--|
| ① | Audio input port | 5-pole Phoenix connector for balanced analog audio. Pin assignment can be found in the Analog Audio Input and Output section. |
| ② | IR IN and OUT | 3-pole TRS connector, also known as 3.5 mm (1/8") jack plug for optional IR receiver (IR IN) and transmitter (IR OUT). Pin assignments can be found in the IR Connector section. |
| ③ | USB | USB interface for LDC connection to control the matrix. |
| ④ | RS-232 | 3-pole Phoenix connector for controlling the device with LDC, third-party control systems, or third-party device control. Pin assignment can be found in the RS-232 Connector section. |
| ⑤ | Ethernet | Locking RJ45 connector for device control and firmware upgrade. |
| ⑥ | Status LEDs | The LEDs give immediate feedback about current state of the device. See the details in the Front Panel LEDs section. |
| ⑦ | Video select button for Output 1 | Pushing the button selects video source for Output 1. See the sequence in the OUT 1 and OUT 2 Video Select Buttons section. |
| ⑧ | Input select LEDs | The LEDs give feedback about the current crosspoint settings. |
| ⑨ | Video select button for Output 2 | Pushing the button selects video source for Output 2. See the sequence in the OUT 1 and OUT 2 Video Select Buttons section. |
| ⑩ | Reset button | Pressing reset button reboots the device. It results the same as unplugging and re-plugging the power connector. |
| ⑪ | Set Audio Config button | Audio configuration and special functions are available through this button. See more information about the audio configuration modes in the Set Audio Config Button section and the special functions in the Enable DHCP (Static) IP Address section. |

Rear View



- | | | |
|---|-----------------------------|--|
| ① | 12V DC 1A input port | Local power in; connect the output of the supplied 12V DC power adaptor. For more details see the next section. |
| ③ | HDMI input ports | HDMI input ports for sources. LED operation can be found in the Rear Panel LEDs section. |
| ④ | HDMI output ports | Connect an HDMI cable between the sink device and the matrix. LED operations can be found in the Rear Panel LEDs section. |
| ⑤ | Audio output port | 5-pole Phoenix connector for balanced analog audio output. Pin assignment can be found in the Analog Audio Input and Output section. |

2.3. MMX4x2-HDMI-USB20-L

Front View

#new

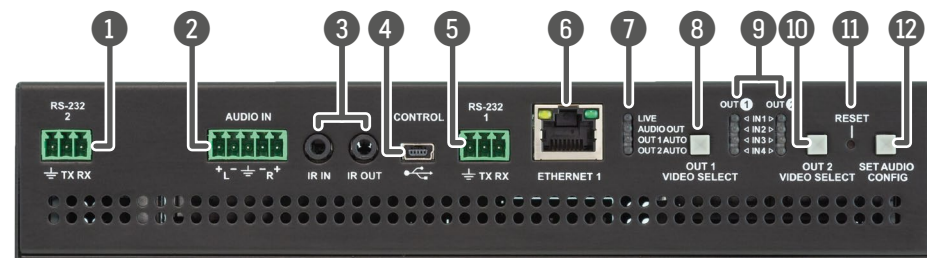

- 1 **RS-232 (#2)** 3-pole Phoenix connector for controlling the device with LDC, third-party control systems, or third-party device control. Pin assignment can be found in the [RS-232 Connector](#) section.
- 2 **Audio input port** 5-pole Phoenix connector for balanced analog audio. Pin assignment can be found in the [Analog Audio Input and Output](#) section.
- 3 **IR IN and OUT** 3-pole TRS connector, also known as 3.5 mm (1/8") jack plug for optional IR receiver (IR IN) and transmitter (IR OUT). Pin assignments can be found in the [IR Connector](#) section.
- 4 **USB** USB interface for LDC connection to control the matrix.
- 5 **RS-232 (#1)** 3-pole Phoenix connector for controlling the device with LDC, third-party control systems, or third-party device control. Pin assignment can be found in the [RS-232 Connector](#) section.
- 6 **Ethernet (#1)** RJ45 connector for network-sharing, applying device control or performing a firmware upgrade.
- 7 **Status LEDs** The LEDs give immediate feedback about current state of the device. See the details in the [Front Panel LEDs](#) section.
- 8 **Video select button for Output 1** Pushing the button selects video source for Output 1. See the sequence in the [OUT 1 and OUT 2 Video Select Buttons](#) section.
- 9 **Input select LEDs** The LEDs give feedback about the current crosspoint settings.
- 10 **Video select button for Output 2** Pushing the button selects video source for Output 2. See the sequence in the [OUT 1 and OUT 2 Video Select Buttons](#) section.
- 11 **Reset button** Pressing reset button reboots the device. It results the same as unplugging and re-plugging the power connector.
- 12 **Set Audio Config button** Audio configuration and special functions are available through this button. See more information about the audio configuration modes in the [Set Audio Config Button](#) section and the special functions in the [Enable DHCP \(Static\) IP Address](#) section.



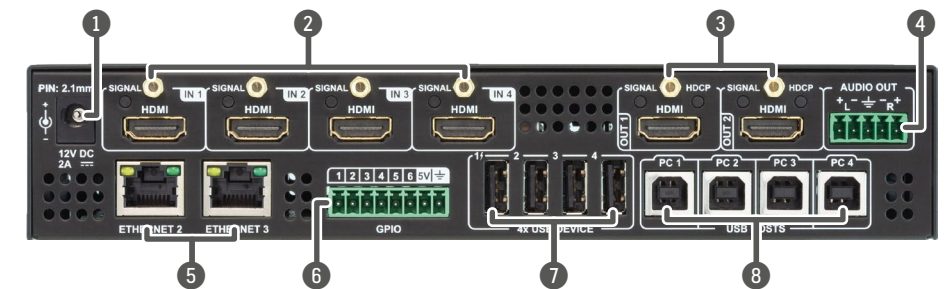







Rear View



- 1 **12V DC input connector** Local power in; connect the output of the supplied 12V DC power adaptor.
- 2 **HDMI input ports** HDMI input ports for sources. LED operation can be found in the [Rear Panel LEDs](#) section.
- 3 **HDMI output ports** Connect an HDMI cable between the sink device and the matrix. LED operations can be found in the [Rear Panel LEDs](#) section.
- 4 **Audio output port** 5-pole Phoenix connector for balanced analog audio output. Pin assignment can be found in the [Analog Audio Input and Output](#) section.
- 5 **Ethernet (#2)** RJ45 connector for network-sharing, applying device control or performing a firmware upgrade.
- 6 **GPIO port** 8-pole Phoenix connector with configurable general purpose input/output pins.
- 7 **USB-A ports** Downstream ports for connecting USB peripherals (e.g. camera, keyboard, multitouch display).
- 8 **USB-B ports** Upstream ports for connecting USB host devices (e.g. computer).



2.4. Front Panel LEDs

Status LEDs











LIVE LED			
		off	The device is not powered.
	green	blinking slow	Device is powered and operational.
	green	blinking fast	Device is in bootload mode (firmware upgrade).
	green	on	The device is powered but no operation.
AUDIO OUT LED			
		off	Embedded audio is not present or analog audio output is muted.
	green	blinking	Embedded audio format is not supported for audio de-embedding.
	green	on	Embedded audio is present and de-embedded.
OUT 1 AUTO LED			
		off	Autoselect is disabled on HDMI Output 1.
	green	on	Autoselect is enabled on HDMI Output 1.
OUT 2 AUTO LED			
		off	Autoselect is disabled on HDMI Output 2.
	green	on	Autoselect is enabled on HDMI Output 2.

INFO: You can find more information about Autoselect feature in [The Autoselect Feature](#) section.

Crosspoint Status LEDs

IN1..IN4 LEDs			
	green	blinking	Input is selected, signal is not present.
	amber	blinking	Pre-programmed audio configuration (1..4) is selected by the Set Audio Config button. See the details in the Set Audio Config Button section.
	green	on	Input is selected, signal is present.

2.5. Rear Panel LEDs

HDMI input LEDs			
		off	Signal is not present on input.
	green	on	Signal is present on input.
TPS input LED (only at MMX4x2-HT200 model)			
		off	No TPS link is established between the matrix and the transmitter.
	green	blinking	Low power mode or Ethernet fallback mode is active, see details in the Consuming Electronics Control (CEC) Interface section.
	green	on	TPS link is established.
HDMI output LEDs			
		off	Output signal is not present or muted.
	green	on	Signal is present.
HDCP LEDs			
		off	Output signal is not HDCP-encrypted.
	green	blinking	Non-HDCP capable device is connected, encrypted signal is replaced with red screen.
	green	on	Output signal is HDCP-encrypted.

2.6. Front Panel Buttons

2.6.1. OUT 1 and OUT 2 Video Select Buttons

You can select the input source for the desired output port with pushing the buttons. The sequence is the following for each device.

MMX4x2-HDMI: #autoselect

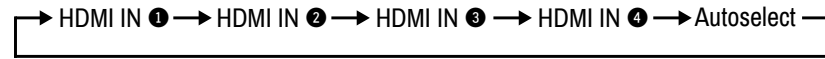

MMX4x2-HT200:

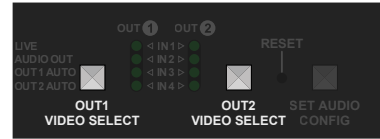

2.6.2. Set Audio Config Button

You can select the pre-programmed audio configuration mode with pushing the button. The sequence is the following:

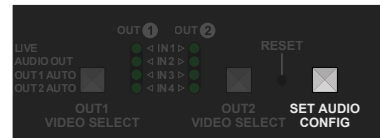
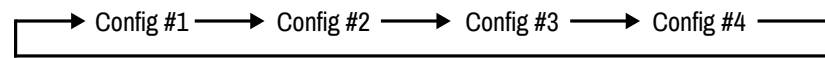

When the **Set audio config** button is pressed the given audio config is loaded and the corresponding <IN#> LEDs blink in amber six times. E.g. if **Config #3** is loaded the <IN3> LEDs blink six times.

Config #1			
Copy HDMI OUT 1 audio to HDMI OUT 2 and Analog Audio Out.			
A1 (HDMI OUT 1, Stream 1)	A2 (HDMI OUT 2, Stream 2)	A3 (Analog In)	
✓			O1 (HDMI OUT 1)
✓			O2 (HDMI OUT 2)
✓			O3 (ANALOG OUT)

Config #2			
Copy HDMI OUT 2 audio to HDMI OUT 1 and Analog Audio Out.			
A1 (HDMI OUT 1, Stream 1)	A2 (HDMI OUT 2, Stream 2)	A3 (Analog In)	
	✓		O1 (HDMI OUT 1)
	✓		O2 (HDMI OUT 2)
	✓		O3 (ANALOG OUT)

Config #3			
Use audio from Analog Input on all outputs.			
A1 (HDMI OUT 1, Stream 1)	A2 (HDMI OUT 2, Stream 2)	A3 (Analog In)	
		✓	O1 (HDMI OUT 1)
		✓	O2 (HDMI OUT 2)
		✓	O3 (ANALOG OUT)

Config #4			
Keep Original Audio on HDMI outputs, de-embed from HDMI OUT 2 to Analog Audio Out.			
A1 (HDMI OUT 1, Stream 1)	A2 (HDMI OUT 2, Stream 2)	A3 (Analog In)	
✓			O1 (HDMI OUT 1)
	✓		O2 (HDMI OUT 2)
	✓		O3 (ANALOG OUT)

2.6.3. Enable DHCP (Static) IP Address

The device has a static IP address as a factory default setting. If this setting does not fit to the circumstances during install or usage, DHCP can be enabled from the front panel:

- Step 1.** Make sure the device is powered on and operational.
- Step 2.** Press and keep pressed the **Set Audio Config** button for 5 seconds.
- Step 3.** After 5 seconds front panel LEDs start blinking; release the button and press it **3 times again** quickly (within 3 seconds).
- Step 4.** The LEDs get dark, DHCP gets enabled. `#dhcp`



2.6.4. Reset to Factory Default Settings

To restore factory default values, do the following steps:

- Step 1.** Make sure the device is powered on and operational.
- Step 2.** Press and keep pressed the **Set Audio Config** button for 10 seconds. After 5 seconds front panel LEDs start blinking but keep on pressing the button.
- Step 3.** After 10 seconds the LEDs start blinking faster; release the button and press it **3 times again** quickly (within 3 seconds).
- Step 4.** The LEDs get dark, the device restores the factory default settings and reboots. `#factory`



Factory default settings are listed in the [Factory Default Settings](#) section.

2.6.5. Resetting the Device

In a few cases (after firmware upgrade, etc) you may need to reset the device. Pushing the reset button results the same as you disconnect and reconnect the power adaptor to the matrix. To resetting the device follow the steps: `#reboot #restart`

- Step 1.** Push the button with a thin object for a second.
- Step 2.** Wait until the device reboots. You can use the matrix when the LIVE LED is blinking slowly again.



ATTENTION! Resetting the device does not reset the settings to factory defaults. To reset factory default settings see the previous section.

2.6.6. Control Lock

Press the **OUT2 Video Select** and **Set Audio Config** buttons **together** (within 100 ms) to disable/enable front panel buttons; front panel LEDs blink 4 times when locking/unlocking. If the control lock is enabled and a button is pressed, front panel LEDs blink 3 times quickly.



2.6.7. Entering Firmware Upgrade Mode

ATTENTION! This function is applicable only in special cases when the device is to be upgraded by the Lightware Device Updater (LDU) software. Do not use this option with LDU2 software.

It may happen that the firmware upgrade process is not successful and the device cannot be switched to bootload mode automatically. In this case, the device can be forced into firmware upgrade mode as follows:

- Step 1.** Make sure the matrix is powered off.
- Step 2.** Press and keep pressed the **Set Audio Config** button.
- Step 3.** **Power on the matrix** while the **Set Audio Config** button is being pressed. If the device is switched to firmware upgrade mode the LIVE LED is blinking quickly (less than 500 ms duty cycle). The other LEDs are off.

The procedure of firmware upgrade can be found in the [Firmware Upgrade](#) chapter.

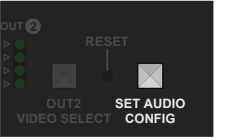

3

Installation

The chapter is about the installation of the device and connecting to other appliances, presenting also the mounting options and further assembly steps.

- ▶ [MOUNTING OPTIONS](#)
- ▶ [ELECTRICAL CONNECTIONS](#)
- ▶ [CONNECTING STEPS](#)

3.1. Mounting Options

To mount the matrix Lightware supplies optional accessories for different usage. There are two kinds of mounting kits with similar fixing method. The receiver has two mounting holes with inner thread on the bottom side; see the bottom view in the [Mechanical Drawings](#) section. To order mounting accessories please contact sales@lightware.com. Fasten the device by the screws enclosed to the accessory.

WARNING! Always use the supplied screws. Using different (e.g. longer) ones may cause damage to the device.

INFO: The matrix is half-rack sized.

3.1.1. 1U High Rack Shelf

Allows rack mounting for half-rack, quarter-rack and pocket sized units.



1U high rack shelf

1U high rack shelf provides mounting holes for fastening two half-rack or four quarter-rack sized units. Pocket sized devices can also be fastened on the self.

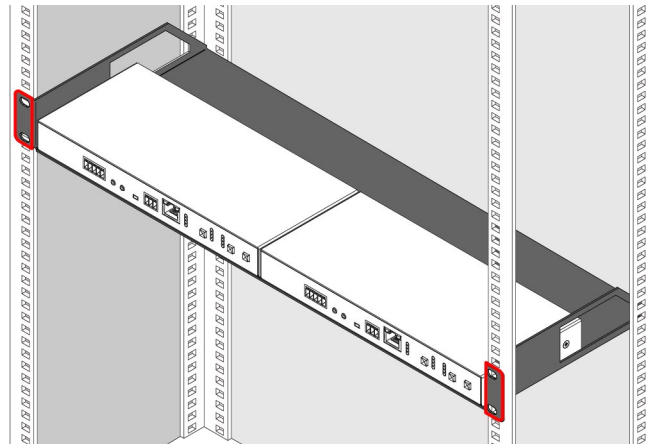

3.1.2. Under-desk Double Mounting Kit

DIFFERENCE: This kind of mounting is recommended for MMX4x2-HDMI and MMX4x2-HT200 models only.



Under-desk double mounting kit

The UD-kit double makes it easy to mount a single matrix on any flat surface (e.g. furniture). The mounting of the UD-kit is the same as for UD-kit double.

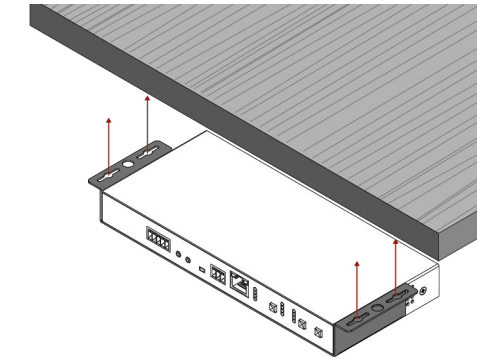

INFO: The chipboard screws are not supplied with the mounting kit.

3.1.3. Rack Ear-mounting

DIFFERENCE: This kind of mounting is available for MMX4x2-HDMI-USB20-L model only. #new

The device can be mounted by the supplied rack ears.

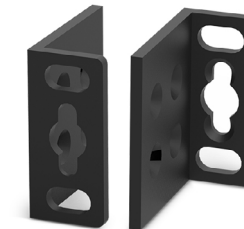

Rack ears

Use the M4 Allen-head screws supplied with the matrix to fix the ear to the housing. The design allows rotating the ears by 90°; choose the layout that fits the best for the installation.

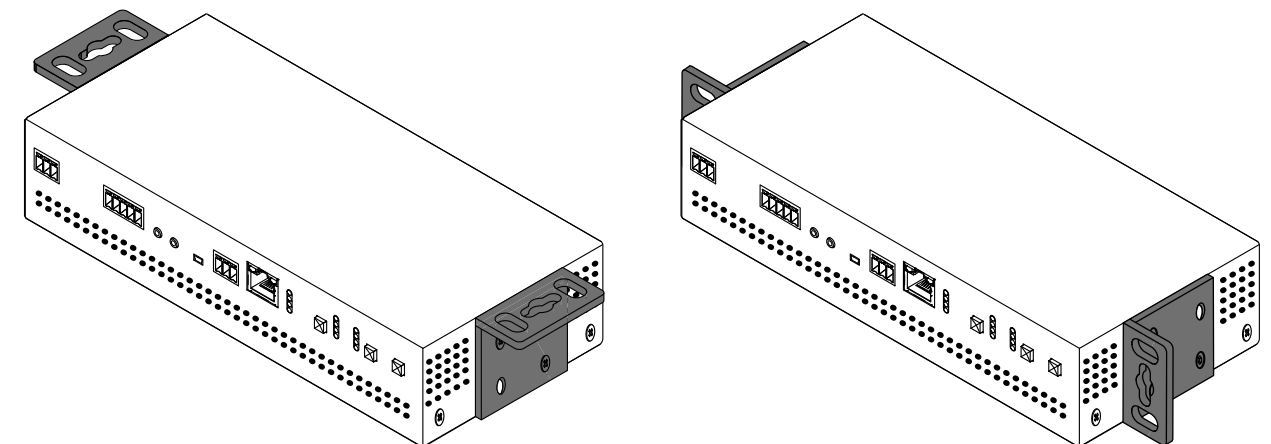

3.2. Electrical Connections

3.2.1. 12V DC Connection

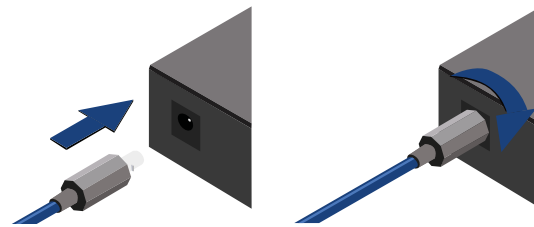

Locking DC connector

Do not forget to turn the plug clockwise direction before disconnecting the power adaptor.

WARNING! Always use the supplied 12V power adaptor. Warranty void if damage occurs due to use of a different power source.

3.2.2. HDMI Connector

The device provides standard 19 pole HDMI connector for output. Always use high quality HDMI cable for connecting sources and displays.



3.2.3. Analog Audio Input and Output

5-pole Phoenix connector is used for balanced analog audio input and output. Unbalanced audio signals can be connected as well. For unbalanced output connect + and ground to the source and connect – to the ground.



Pin nr.	Signal
1	Left+
2	Left-
3	Ground
4	Right-
5	Right+

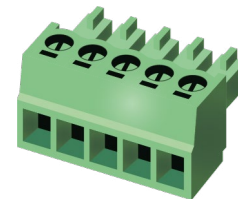

Analog audio connector and plug pin assignments

Compatible Plug Type

Phoenix® Combicon series (3.5mm pitch, 5-pole), type: MC 1.5/5-ST-3.5.

You can find more information about analog audio function in the [Audio Interface](#) section. Audio cable wiring guide is in the [Cable Wiring Guide](#) section.

3.2.4. RJ45 Connectors (TPS and Ethernet Ports)

The device provides standard RJ45 connectors for TPS IN and LAN ports. Always use high quality Ethernet cable for connecting transmitters and receivers. Maximum CATx cable distances for the TPS connection can be found in the [Mechanical Drawings](#) section.

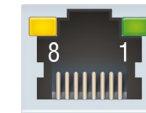

RJ45 connector for Ethernet

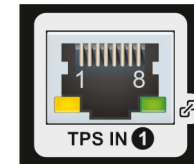

RJ45 connector for TPS input port

Wiring of TPS and LAN Cables

Lightware recommends the termination of LAN cables on the basis of TIA/EIA T 568 A or TIA/EIA T 568 B standards.

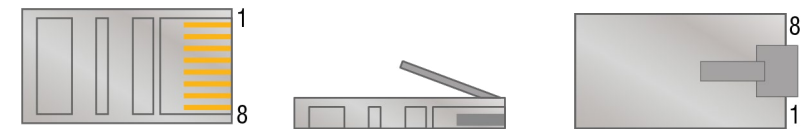

Pin	TIA/EIA T568A	Wire color	TIA/EIA T568B	Wire color
1		white/green		white/orange
2		green		orange
3		white/orange		white/green
4		blue		blue
5		white/blue		white/blue
6		orange		green
7		white/brown		white/brown
8		brown		brown

You can find more information about TPS interface in the [Consuming Electronics Control \(CEC\) Interface](#) section.

3.2.5. USB Connectors

The matrix provides standard USB mini B-type connector on the front panel for device control purposes.

DIFFERENCE: The following ports are available for MMX4x2-HDMI-USB20-L model only.

USB 2.0 B-type ports are for connecting USB host devices (computers).

USB 2.0 A-type ports are for connecting USB peripherals (camera, multi-touch display, etc...).



3.2.6. IR Connector

IR detector and IR emitter can be connected to the matrix with TRS (Tip, Ring, and Sleeve) connectors. They are also known as (3,5 mm or approx. 1/8") audio jack, phone jack, phone plug, and mini-jack plug. The pin assignments are the following for the detector and the emitter:



Detector – 3-pole TRS		Emitter – 2-pole TS	
1 Tip	Signal (active low)	1 Tip	+5V
2 Ring	GND	2 Ring	Signal (active low)
3 Sleeve	+5V	3 Sleeve	

INFO: Ring pole of the emitter is optional. If your IR emitter has three-pole TRS plug, then the Ring and the Sleeve carry the same signal (Output -).

You can find more information about Infrared interface in the [IR Interface](#) section.

3.2.7. RS-232 Connector

The matrix contains a 3-pole Phoenix connector which is used for RS-232 serial connection.



Pin nr.	Signal
1	Ground
2	TX data
3	RX data

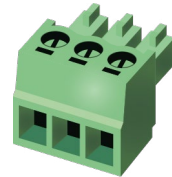

RS-232 connector pin assignments

Compatible Plug Type

Phoenix® Combicon series (3.5mm pitch, 3-pole), type: MC 1.5/3-ST-3.5.

You can find more information about RS-232 interface in the [RS-232 Serial Interface](#) section.

3.2.8. GPIO - General Purpose Input/Output Ports

DIFFERENCE: This section refers to MMX4x2-HDMI-USB20-L model only. #new

The matrix switcher contains a 8-pole Phoenix connector with six GPIO pins, which operates at TTL digital signal levels and can be set to high or low level (Push-Pull). The direction of the pins can be input or output (adjustable). Voltage ranges for GPIO inputs are the following:

	Input voltage [V]	Output voltage [V]	Max. current [mA]
Logical low level	0 - 0,8	0 - 0.5	30
Logical high level	2 - 5	4.5 - 5	18

INFO: The maximum total current for the six GPIO pins is 180 mA.



Pin no.	Level and direction
1	Configurable
2	
3	
4	
5	
6	
7	5V (max 500mA)
	Ground

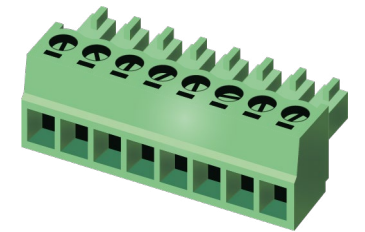

GPIO connector and plug pin assignments

ATTENTION! The sum of the current that the GPIO and the USB-A ports can supply together is max. 2A.

Compatible plug type

Phoenix® Combicon series (3.5mm pitch 8-pole), type: MC 1.5/8-ST-3.5.

You can find more information about GPIO interface in the [GPIO Interface](#) section.

3.3. Connecting Steps

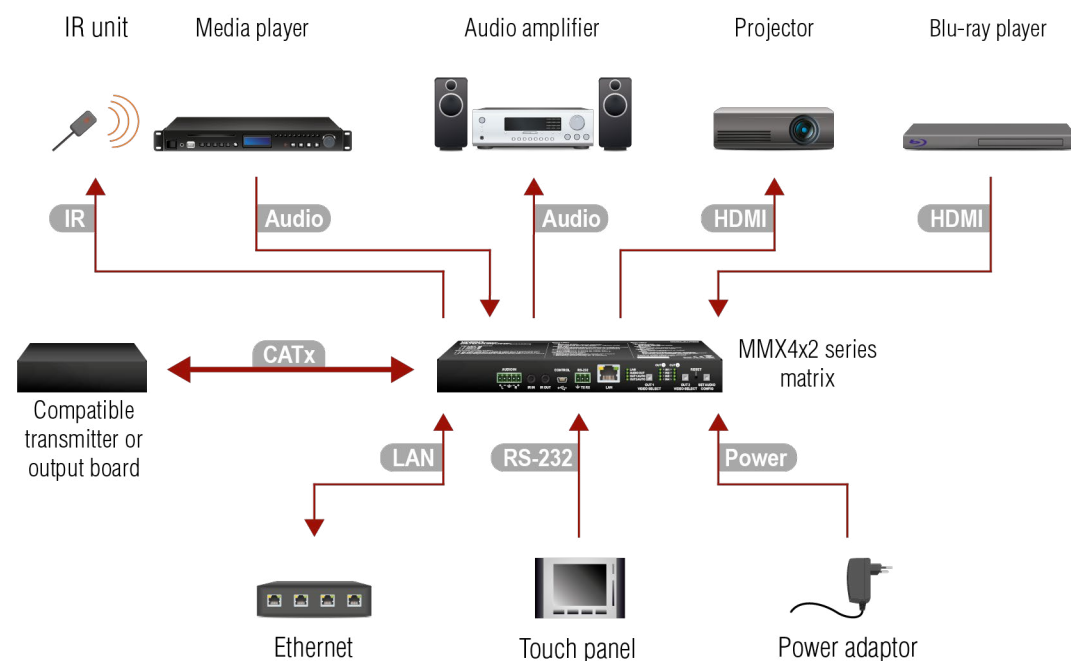

MMX4x2-HDMI-USB20-L

#new

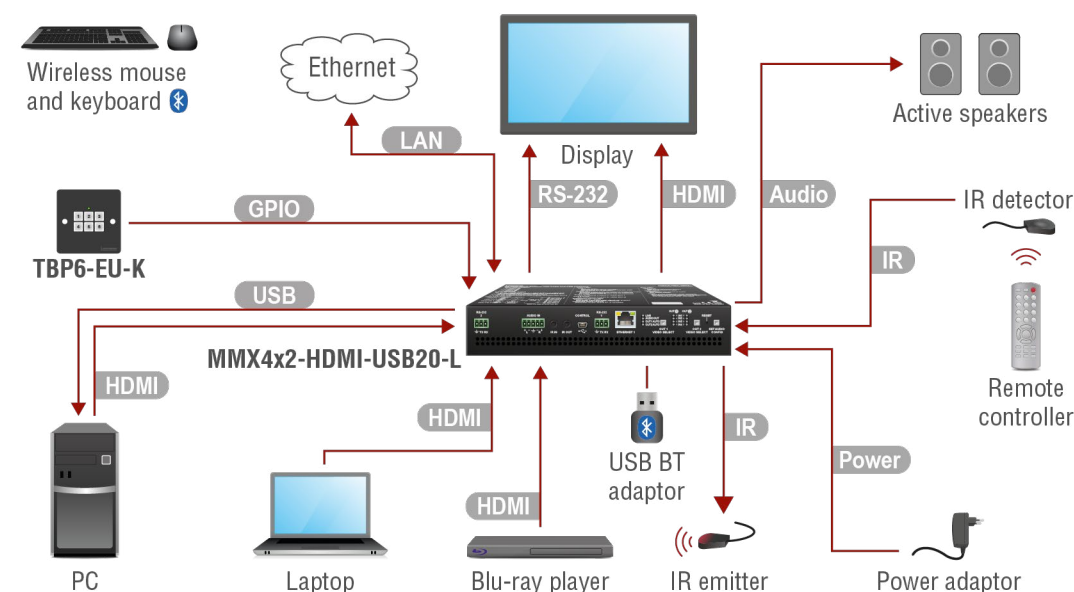

- CATx** For **MMX4x2-HT200 model only**: connect the matrix and the transmitter by a CATx cable via the TPS connectors.
- HDMI** Connect the matrix and the input sources (e.g. Blu-ray player) by HDMI cables via the HDMI input ports.
- HDMI** Connect the sink devices to the HDMI output ports.
- Audio** Optionally connect an audio device (e.g. a media player) to the audio input port.
- Audio** Optionally connect an audio device (e.g. a audio amplifier) to the audio output port.
- LAN** Optionally connect the matrix to a LAN network in order to control the device.
- RS-232** Optionally for RS-232 extension: connect a controller/controlled device (e.g. touch panel) to the RS-232 port.
- IR** Optionally for Infrared extension:
 - Connect the IR emitter to the IR OUT port of the device.
 - Connect the IR detector to the IR IN port of the device.
- Power** Connect the power adaptor to the DC input on the matrix first, then to the AC power socket.

- HDMI** Connect the source devices (e.g. PC, Laptop, Blu-ray player) to the HDMI input ports of the matrix by HDMI cables.
- HDMI** Connect the sink devices (e.g. Display) to the HDMI output ports of the matrix by HDMI cables.
- Audio** Optionally connect an audio device (e.g. Active speakers) to the analog audio output port by an audio cable.
- LAN** Optionally connect the matrix to a LAN in order to control the device and/or to connect further devices to the Ethernet.
- RS-232** Optionally connect the Display over RS-232 to send control commands.
- USB** Connect a USB host device (e.g. PC) to the USB-B (upstream) port of the matrix.
- USB** Connect the desired USB peripherals (e.g. Bluetooth adaptor) to the USB-A (downstream) ports of the matrix.
- IR** Optionally for Infrared extension:
 - Connect the IR emitter to the IR OUT port of the matrix, and/or
 - Connect the IR detector to the IR IN port of the matrix.
- GPIO** Optionally connect a device to the GPIO port (e.g. Lightware's TBP6-EU-K button panel for room control options).
- Power** Connect the power adaptor to the DC input on the matrix first, then to the AC power socket.

4

Device Concept

The following chapter describes the features of the device with a few real-life examples.

- ▶ [COMPACT SIZE MATRIX CONCEPT](#)
- ▶ [VIDEO INTERFACE](#)
- ▶ [CONSUMING ELECTRONICS CONTROL \(CEC\) INTERFACE](#)
- ▶ [AUDIO INTERFACE](#)
- ▶ [THE AUTOSELECT FEATURE](#)
- ▶ [USB INTERFACE](#)
- ▶ [ETHERNET INTERFACE](#)
- ▶ [TPS INTERFACE](#)
- ▶ [RS-232 SERIAL INTERFACE](#)
- ▶ [IR INTERFACE](#)
- ▶ [GPIO INTERFACE](#)
- ▶ [FURTHER BUILT-IN FEATURES](#)

4.1. Compact Size Matrix Concept

MMX4x2 series device is a multifunctional audio/video matrix switcher with four inputs and two outputs designed into a compact size frame. The HT200 model is built with HDBaseT™ (TPS) technology. The device can be controlled over various interfaces, e.g. Ethernet, USB, RS-232, and Infrared, and built with audio embedder and de-embedder functions.

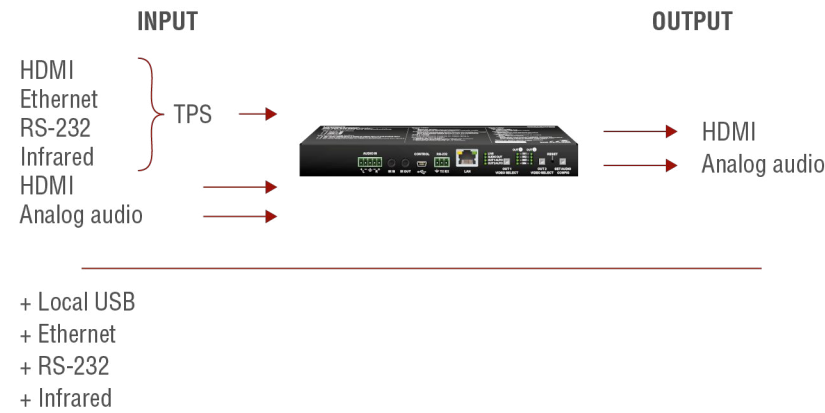

Summary of the interfaces - MMX4x2-HT200

INFO: Only MMX4x2-HT200 model has TPS input. MMX4x2-HDMI model has HDMI+analog audio inputs and HDMI+analog audio outputs.



Summary of the interfaces - MMX4x2-HDMI-USB20-L

#new

4.2. Video Interface

The following figure describes the port diagram of the MMX4x2-HT200 matrix:

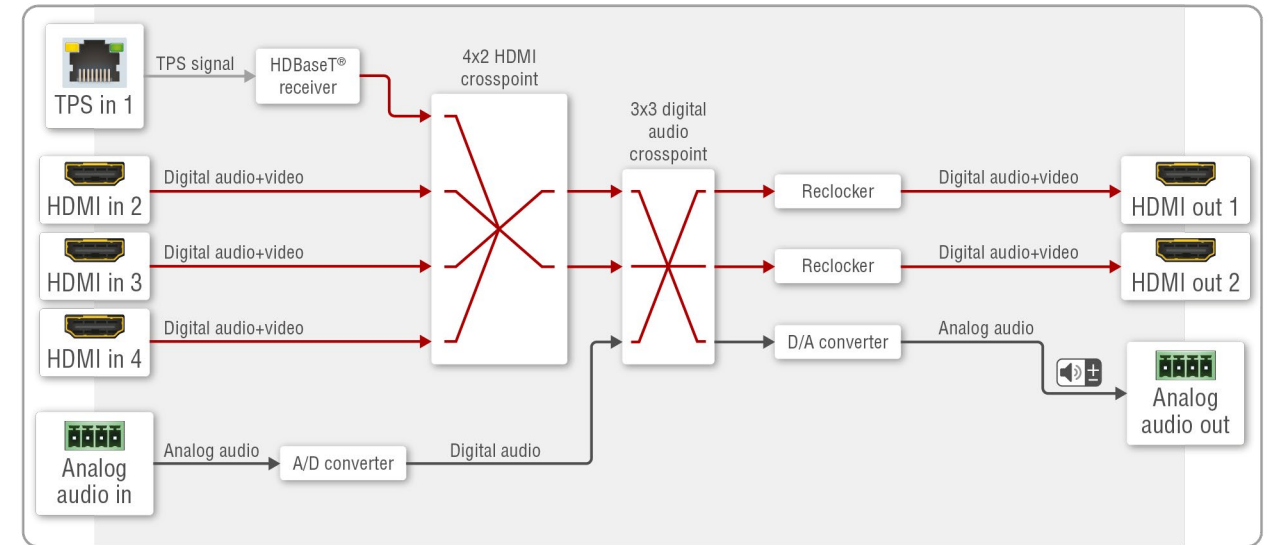

Port diagram of MMX4x2-HT200 matrix switcher

The device has four video input ports (one TPS, three HDMI) and the 4x2 HDMI crosspoint routes the video signal further to the two video output ports (HDMI). The device has also an analog audio input port (5-pole Phoenix) and an analog audio output port (5-pole Phoenix). The 3x3 Digital audio crosspoint routes the audio signals toward the HDMI (audio embedding) and analog audio output ports.

The video crosspoint settings can be controlled by any of the following ways:

- Pressing **OUT 1 / OUT 2 Video Select** button on the device,
- Using Lightware Device Controller (LDC),
- Sending LW2 or LW3 protocol commands, or
- Using the **Autoselect** function.

4.3. Consuming Electronics Control (CEC) Interface

Consumer Electronics Control (CEC) is a bi-directional communication, defined in the HDMI standard. This feature is for remote control of the source and sink devices in the A/V system.

MMX4x2 model is able to send and receive CEC commands, from the input ports towards the source, and from outputs port towards the sink. For more information about sending CEC messages, see [CEC Command Sending](#) section.

CEC has a dedicated pin in the HDMI connector. DVI connector does not contain this pin, so the CEC transmission brakes when HDMI-DVI connector or adapter is in the signal route.

CEC Application Example

When active signal is detected on HDMI in, the switcher sends a CEC message automatically to the HDTV to wake up.

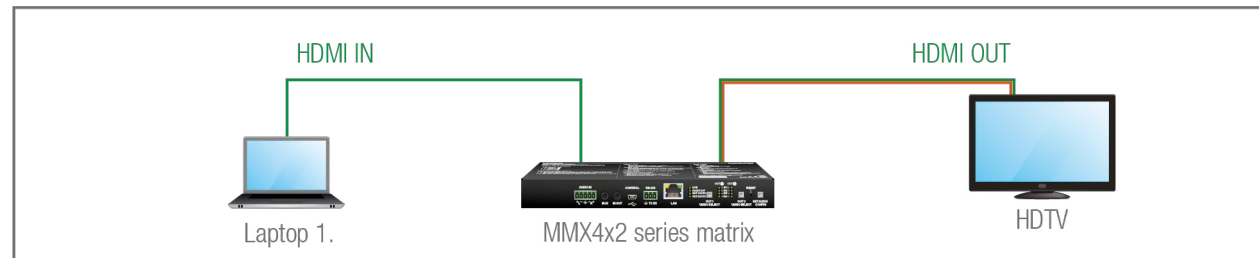

Create an event in the event manager:

- Set as a condition, that the signal is present on the output (O1),
- Set as an action then send a CEC command 'Image view on' O1 output port.

See the details about the Event Manager settings in the [Event Manage](#) section

4.4. Audio Interface

4.4.1. Audio Input Modes

The device can receive embedded audio signal on the HDMI inputs and analog audio signal over the analog audio input port.

In case of MMX4x2-HT200 model embedded audio signal can be received on the TPS input port as well.

Audio Embedding

The matrix has a built-in audio embedder function what means the audio signal which is received on the analog audio input port is able to be embedded to the HDMI outputs.

4.4.2. Audio Output Modes

The MMX4x2 series matrix can transmit two types of audio:

- Embedded (HDMI) and
- Analog balanced stereo audio.

Audio De-embedding

The matrix has a built-in audio de-embedder which means the device is able to de-embed audio from its HDMI outputs to its analog audio output port.

ATTENTION! De-embedding function supports 2 channel PCM audio signals only. Other audio formats are not supported and de-embedding will not be successful.

4.4.3. Audio Options - Example

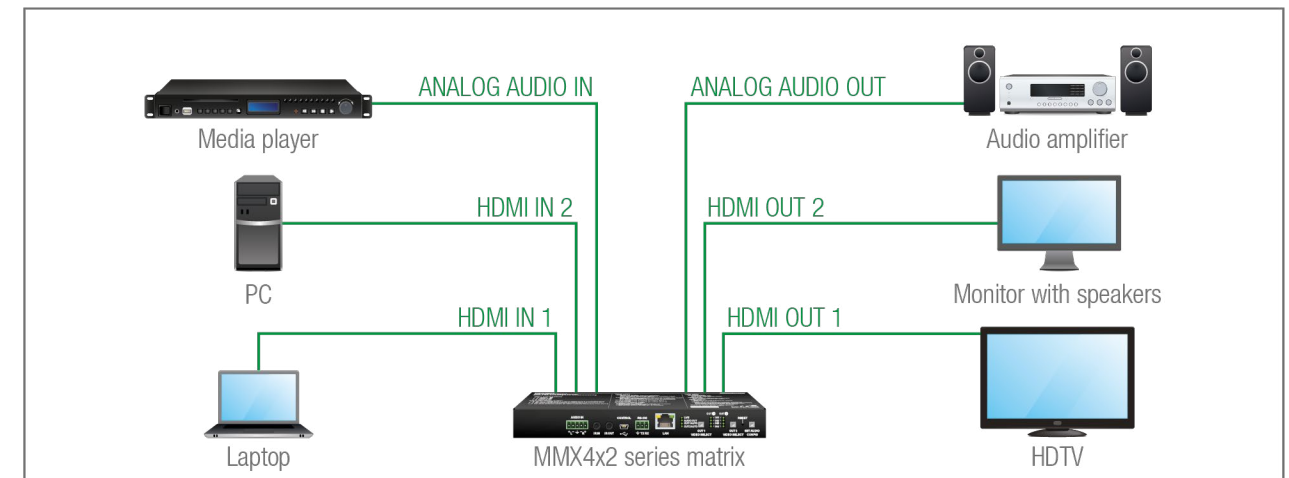

The Concept

Three sources are connected to the matrix: the Laptop on HDMI input 1, the PC on HDMI input 2, and a Media player on the analog audio input. On the output side three sink devices wait for the audio signals: an HDTV on HDMI output 1, a Monitor with speakers on HDMI output 2, and an Audio Amplifier on the analog audio output line. The video line of the Laptop is switched to HDTV and the PC is switched to the Monitor with speakers. The embedding and de-embedding functions of the matrix allow the infinite variations to transmit the analog and digital audio signals.

The following ways are available for the audio devices:

- When the sink device is the **HDTV**, the audio source can be the **Laptop**, the **PC**, and the **Media Player**.
- When the sink device is the **Monitor with speakers**, the audio source can be the **Laptop**, the **PC**, and the **Media player**.
- When the sink device is the **Audio amplifier**, the audio source can be the **Laptop**, the **PC** and the **Media player**.

INFO: All related settings are available in the LDC software, see the details in the [Crosspoint Menu](#) section.

4.5. The Autoselect Feature

Beside of manual selecting of crosspoints you can choose the Autoselect option both in case of audio and video ports.

There are three types of Autoselect as follows:

- **First detect mode:** selected input port is kept connected to the output while it has an active signal.
- **Priority detect mode:** always the highest priority active input is selected to transmit.
- **Last detect mode:** always the last attached input is selected to transmit.

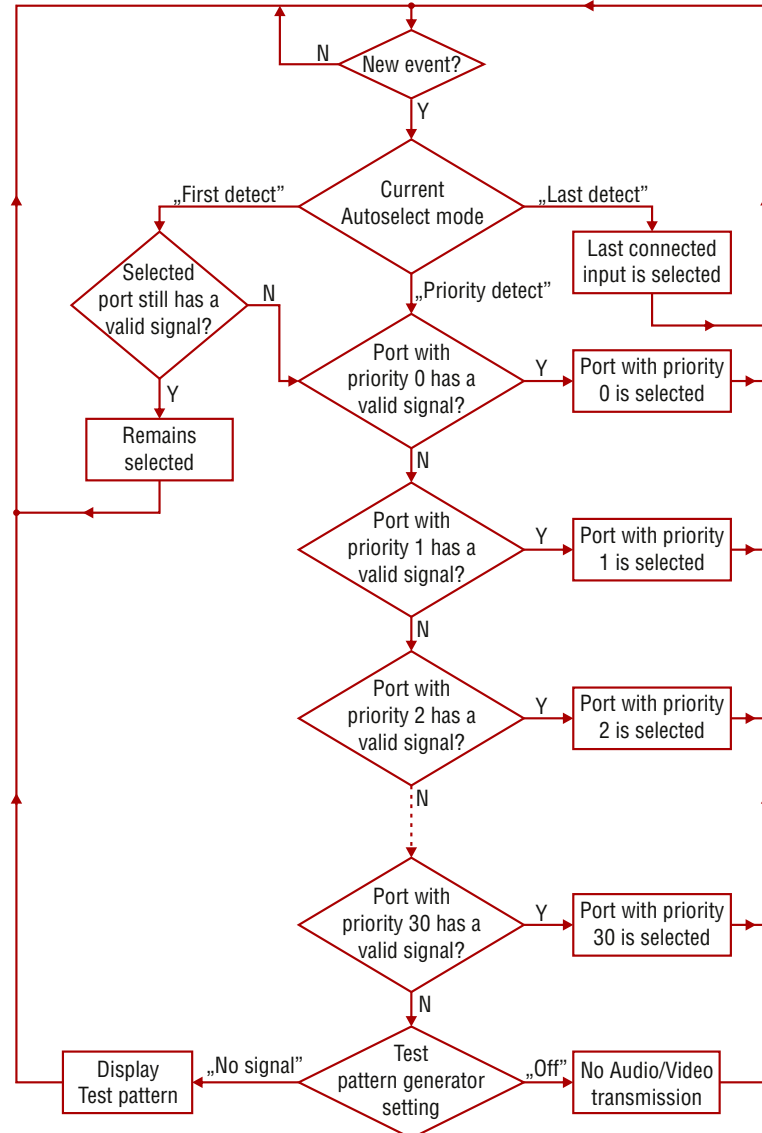

Flowchart of Autoselection modes

Automatic Input Selection - Example

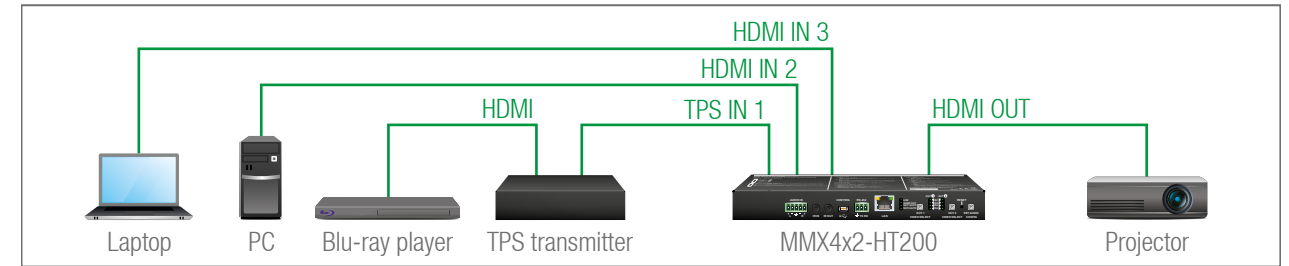

The Concept

If there is no other source connecting to the matrix, only the Laptop, the source on HDMI input 3 will be automatically switched to the HDMI output. If the Laptop and the PC are also connected to the matrix, the source on the HDMI input 2 will be switched to the HDMI output. If the Blu-ray player is connected through the TPS transmitter, TPS input 1 will be switched to the HDMI output – independently of the presence of the other video signals.

Settings

- **HDMI output:** Set the Autoselect to **Enabled**. The Autoselect mode is Priority detect. The priorities are the followings (the lowest number means the highest priority):

Source device	Input port	Priority
Laptop	I3 (HDMI IN 3)	2
PC	I2 (HDMI IN 2)	1
Blu-ray player (via a TPS transmitter)	I1 (TPS IN 1)	0

Priorities can be set in Lightware Device Controller software, see related settings in the [HDMI Video Output](#) section.

4.6. USB Interface

4.6.1. USB Control Interface

The device can be controlled over front panel USB port (mini B-type connector). This interface supports only LW3 protocol. The interface can be used to establish a connection to Lightware Device Controller software.

4.6.2. 4x1 USB 2.0 Switch

DIFFERENCE: This section refers to the MMX4x2-HDMI-USB20-L model only. *#new*

The device contains a built-in USB 2.0 hub. USB host devices (e.g. PC-s) can be connected to the four USB B-type connectors, and USB peripherals (e.g. camera, speakerphone, mouse, etc.) can be connected to the four USB A-type connectors. You can switch the USB peripherals to connect one host device. Please note that only one USB host can be active at the same time, thus, all the connected USB peripherals will be connected to the same USB host device. The connected USB peripherals can be powered up to 500mA, except at the first port where max. 1000 mA can be supplied.

ATTENTION! The sum of the current that the GPIO and the USB-A ports can supply together is max. 2A.

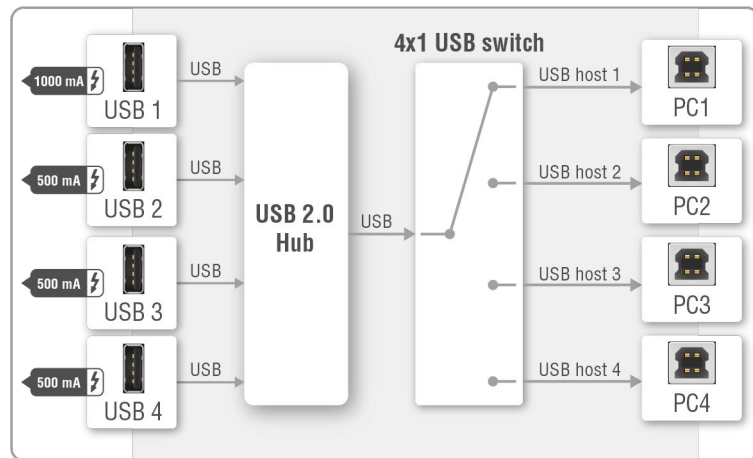

USB port diagram - MMX4x2-HDMI-USB20-L

Switching USB Peripherals to Another PC – Example.

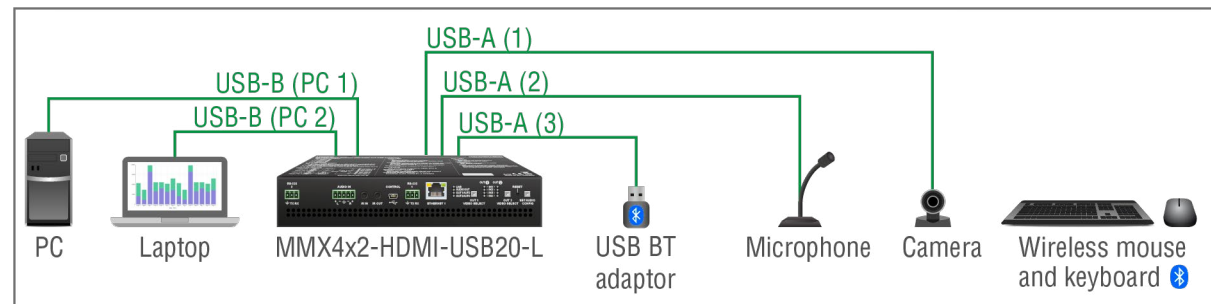

The Concept

The PC and the laptop are connected to USB B-type ports of the matrix switcher (HDMI connection is not necessary for the USB functionality). USB peripherals (camera, microphone, keyboard and mouse) are connected to the USB A-type ports. The user can select to switch the USB peripherals to the PC or to the laptop.

Settings

The PC is connected to the **PC 1** USB B-type port, the laptop is connected to the **PC2** USB B-type port.

Change the USB host device according to the needs by setting the `/MEDIA/USB/USBSWITCH.HostSelect` property to **1** or **2**. It can be established by sending an **LW3** command by an external device, e.g. TBP6-EU Button panel.

The function can be also combined with the **Event manager** to have a more comfortable automatic system: when a USB host device is connected to the **PC3** port, switch the HDMI input 3 to the output 1.

4.7. Ethernet Interface

The device can be controlled over front panel Ethernet port (standard RJ45 connector). This interface supports both LW2 and LW3 protocols.

The interface can be also used to remote control a third-party device and establish the connection to Lightware Device Updater software and perform firmware upgrade.

Third-party Device Control via Local Ethernet (Example)

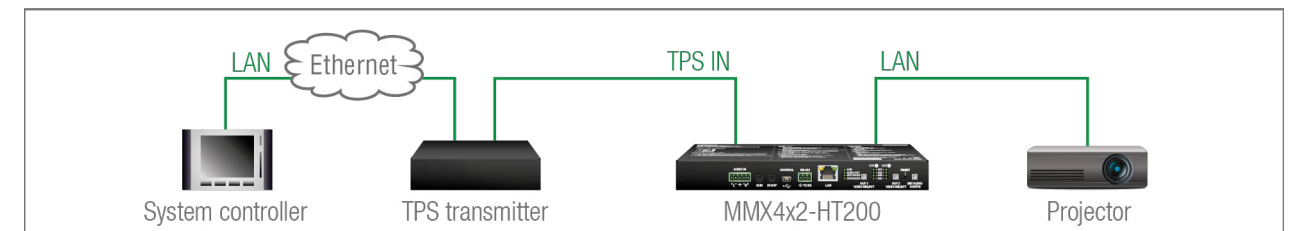

The following ways are available for device control:

- The **System controller** can communicate with the **Matrix** via the TPS line of the **Transmitter** with using LW2/LW3 protocol commands.
- The **System controller** can communicate directly with the **Projector** via their IP:port address.
- The **Matrix** can send commands (e.g. as an action by the Event Manager) to the IP:port address of the **Projector** by using LW3 protocol commands. See Event Manager usage in the [Event Manager](#) section, and find the related LW3 protocol commands in the [Ethernet Message Sending](#) section.

4.8. TPS Interface

DIFFERENCE: This section refers to the MMX4x2-HT200 model only.

The MMX4x2-HT200 model is built with TPS (Twisted Pair Single) interface which are using HDBaseT™ technology. It means the unit receives video, audio, Ethernet, RS-232, and Infrared signals via a single CATx cable.

TPS Interface Working Modes

The TPS working mode between the transmitter and the receiver is determined by the mode set in them. Both devices TPS mode settings together determine the finally established TPS transmission mode.

The following TPS modes are defined in the receiver:

- **Auto:** The TPS mode is determined automatically.
- **HDBaseT:** Ideal for high resolution signals up to 4K.
- **Long reach:** Ideal for big distances up to 1080p@60Hz with extended cable lengths.
- **LPPF1*:** Only RS-232 communication is transmitted (@ 9600 baud).
- **LPPF2*:** Only RS-232 (@ 9600 baud) and Ethernet communication are transmitted.

* LPPF: Low Power Partial Functionality.

		Selected mode on RX side				
		LPPF1	LPPF2	HDBaseT	Long reach	Auto
Selected mode on TX side	LPPF1	LPPF1	LPPF1	LPPF1	LPPF1	LPPF1
	LPPF2	LPPF1	LPPF2	LPPF2	LPPF2	LPPF2
	HDBaseT	LPPF1	LPPF2	HDBaseT	Long reach	HDBaseT
	Long reach	LPPF1	LPPF2	Long reach	Long reach	Long reach
	Auto	LPPF1	LPPF2	HDBaseT	Long reach	HDBaseT **

** If there is valid HDMI/DVI signal is on the TX side, the TPS mode will be HDBaseT on both side. If the transmitter does not transmits HDMI/DVI signal, the TPS mode will be changed to LPPF2 or LPPF1 automatically. Long reach mode is not available when both sides are set to Auto mode.

When using automatic operation mode selection, the device determines the mode of operation. If both half of the pair are set to Auto mode, the source side is the initiator. It will negotiate each state transition with its sink side partner.

When one of the devices is configured to manual operation mode selection, the other device may be placed in automatic mode. In this case, the mode transition negotiation is initiated by the host-managed device and the auto-mode device follows through. The allowed cable lengths and resolutions are listed in the [Maximum Extension Distances](#) section.

4.9. RS-232 Serial Interface

4.9.1. Technical Background

ATTENTION! Only MMX4x2-HT200 model has TPS serial link port.

Serial data communication can be established via the local RS-232 port (Phoenix connector) or via the TPS port. The RS-232 ports – which are connected to the CPU – can be configured separately (e.g. if the Baud rates are different, the CPU does the conversion automatically between the ports). The RS-232 port can be switched to Control mode, Command Injection mode, or can be disconnected; see the figure below.

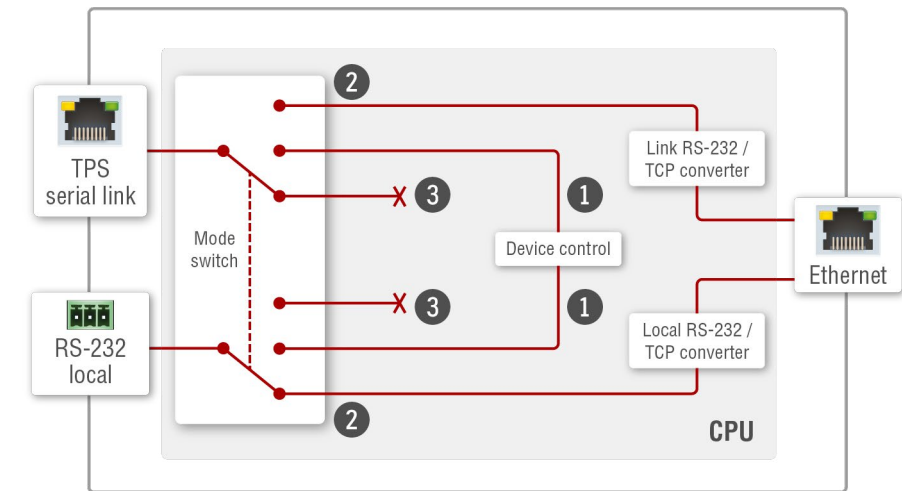

Block diagram of the MMX4x2-HT200 serial interface

The following settings are defined:

- 1 The serial port is in **Control mode**.
- 2 The serial port is in **Command Injection mode**.
- 3 The serial port is **Disconnected**.

INFO: All settings are available in the LDC software, see details in the [RS-232](#) section.

Only one mode can be used at a time: Control mode, or Command Injection mode, or can be disconnected. You can set different modes for the TPS serial link and local RS-232 port.

Control Mode

The incoming data from the given port is processed and interpreted by the CPU. The mode allows to control the matrix directly. LW2 or LW3 protocol commands are accepted – depending on the current port setting.

Command Injection Mode

In this mode, the matrix works as a TCP/IP <-> RS-232 bidirectional converter. The TCP/IP data signal is converted to RS-232 data and vice versa. TCP/IP port numbers are defined for the serial ports (TPS and local) for this purpose. E.g. the default Command Injection port number of the local RS-232 port is 8001. If data is coming from the TPS interface which addresses to the port no. 8001, it will be transmitted to the Tx pin of the local RS-232 port. That also works in the opposite direction of course and the method is the same on the serial interface of the TPS port as well.

RS-232 Signal Transmission – Example

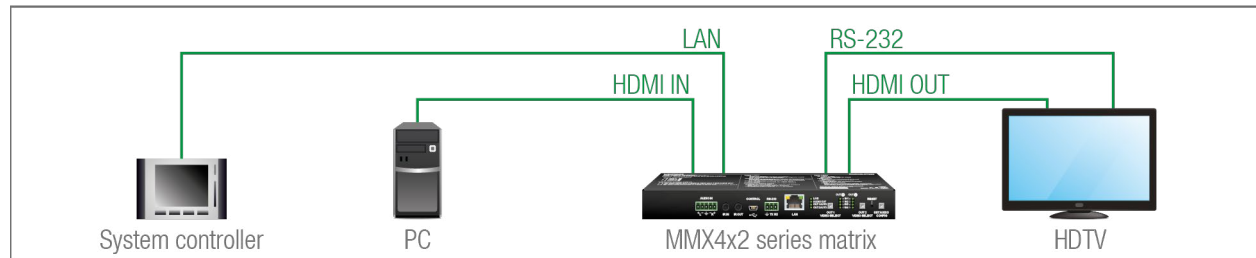

The following ways are available for controlling the devices:

- The **System controller** can send TCP messages to the IP:port address of the **Matrix**. In this case the control is one-way, the System controller sends commands to the **HDTV**. You can see the details about TCP message sending in the [Ethernet Message Sending](#) section.
- The **System controller** sends messages over the LAN port of the **Matrix** to the given port number. The Matrix converts the incoming TCP messages to RS-232 commands and transmits over the local RS-232 port to the **HDTV**. The local RS-232 port has to be set to Command Injection mode. In this case the direction of the communication is bi-directional between the Matrix and the System controller, so the answer of the HDTV is received by the System controller.

4.9.2. RS-232 Recognizer

This tool is able to recognize and store the incoming RS-232 message until the previously defined string (delimiter) is arrived or the timeout elapsed after the last data. The last incoming serial data is stored and it can trigger an action in Event Manager.

RS-232 Recognizer Example

When the **MMX4x2** has an active video signal, the switcher login the VC codec automatically.

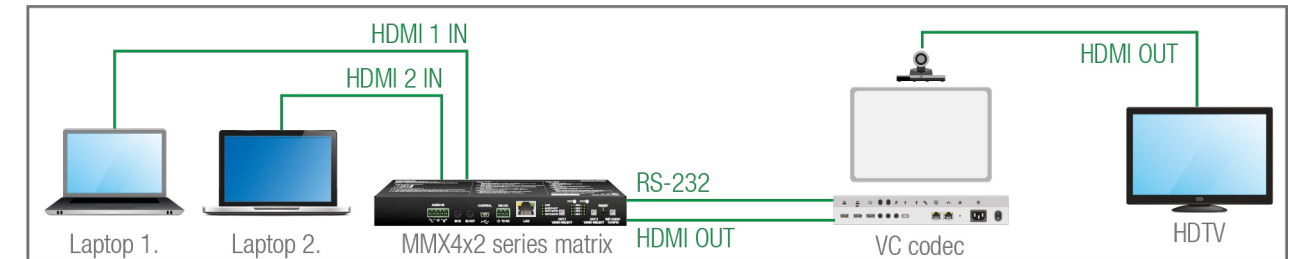

When the active signal appears on the output of the MMX4x2, it triggers a bi-directional communication with the VC codec via RS-232:

- ▶ MMX4x2 (starts the communication on RS-232): **PING**
- ◀ VC codec (requests the login name): **Login name:**
- ▶ MMX4x2 (sends the login name): **Admin**
- ◀ VC codec (requests the password): **Password:**
- ▶ MMX4x2 (sends the password): **Admin**

First, configure the recognizer for the serial communication, after that, set the events in the Event Manager.

The RS-232 recognizer settings has to be with LW3 protocol commands (see more information in [RS-232 Message Recognizer](#) section).

Create the following events in the event manager:

E1. When the signal is present on O1 port of the MMX4x2, it sends a message '**PING**' on P1 port of RS-232 to the VC codec. For more details see [RS-232 Message Recognizer](#) section.

E2. Set a condition where **Login name:** is the recognized RS-232 message. Action is sending serial message ('**Admin**') on the P1 port to the VC codec.

E3. Set a condition where **Password:** is the recognized RS-232 message. Action is sending serial message ('**Admin**') on the P1 port to the VC codec.

For more information about setting the events, see [Event Manager](#) section.

4.10. IR Interface

ATTENTION! The device has no built-in Infrared receiver and transmitter. For the complete usage attach the supplied IR emitter unit to the IR OUT and the IR detector unit to the IR IN connectors.

Technical Background

ATTENTION! Only MMX4x2-HT200 model has TPS LAN port.

The Infrared signal transmission is similar to the serial data communication. The MMX4x2 series matrix contains dedicated IR I/O connection and the MMX4x2-HT200 model can also transmit/receive IR signal via the TPS interface. The signal is in pronto HEX format in both cases.

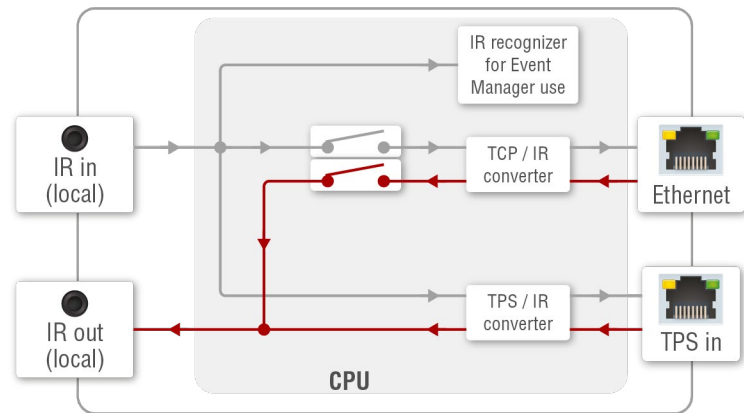

Block diagram of the IR interface

With the help of the device's IR recognizer functionality you can assign actions in Event manager. The second option is the command injection mode (like at serial interface in the previous section) where you can send IR commands over LAN. Command injection mode can be turned on and off by input/output ports.

INFO: All settings are available in the LDC software, see settings in the [Infra](#) section.

INFO: The modulation of output IR signal can be turned off or on by LW3 command, see the [Enable/Disable Output Signal Modulation](#) section.

Control by IR Signal - Example

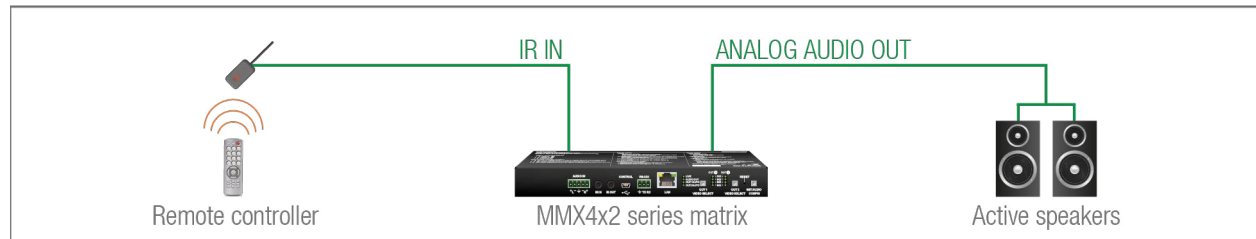

The Concept

An IR detector is attached to the Infrared input port of the Matrix and IR signals are sent by the Remote controller. A pair of active speakers is also connected to the analog audio output port of the Matrix.

The volume can be controlled via the Matrix by using the remote controller with the following way:

- Set an action in **Event Manager** that if the volume control buttons are pressed on the **Remote controller**, increase or decrease the volume of the analog audio port of the **Matrix**. In this case you can control the audio device via the Matrix remotely. See the details about the Event Manager settings in the [Event Manager](#) section.

TIPS AND TRICKS: You can increase or decrease the levels of analog audio output ports in steps by LW3 protocol commands, see the details in the [Analog Audio Output Level Settings by Steps](#) section.

Advanced IR functionality

MMX4x2 series can send Little-endian pronto hex IR codes on its IR output port.

It is possible in the following ways:

- With Event Manager (see more details in the [Event Manager](#) section)

The code can be saved into the action in the event manager with the following parameters:

Category: Infra; **Expression:** Send pronto hex; **Port:** D1 or ; **Pronto hex:** <custom_code> .The maximum length of the code can be 184 characters (184 bytes).

- With LW3 protocol command (for more information see [Infrared Message Sending](#)). The maximum length of the code can be 765 characters (765 bytes).

Sending Bigger-endian pronto hex code is also available, see [Sending Pronto Hex Codes in Big-endian Format via IR Port](#).

4.11. GPIO Interface

DIFFERENCE: This section refers to the MMX4x2-HDMI-USB20-L model only. *#new*

The General Purpose Input/Output (GPIO) port is a multifunctional input/output interface to control the matrix switcher or third-party devices and peripherals. You can establish the connection between the controller/controllable device and the matrix switcher by the 8-pole Phoenix connector. The direction of the six pin is configurable independently from each other.

GPIO Options - Example

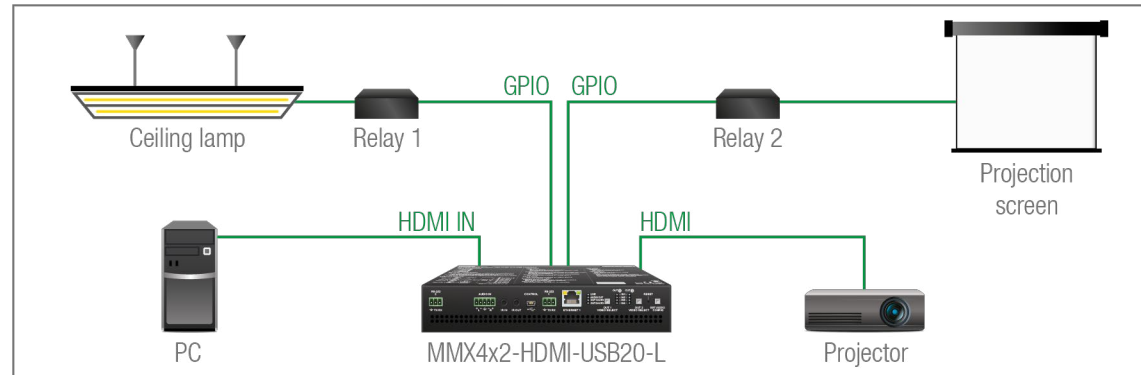

The Concept

Ceiling lamp is turned off by Relay 1 and projection screen is rolled down by Relay 2 when signal received from the PC over the HDMI input. Both relays are controlled by the GPIO port.

Settings of the Transmitter

- **For Relay 1:** create an event in Event manager: when signal is present on Input 1 (I1) then set GPIO pins to low level for Relay 1 opening. Also create another event when signal is not present on Input 1 (I1) then set GPIO pins to high level for Relay 1 closing.
- **For Relay 2:** create an event in Event manager when signal is present on Input 1 (I1) then set GPIO pins to high level for Relay 2 closing. Also create another event when signal is not present on Input 1 (I1) then set GPIO pins to low level for Relay 2 opening.

When the PC starts to play the video presentation, the signal is received over the HDMI input so GPIO pins send signal to Relay 1 to open which results turning off the lights. Furthermore, GPIO pins also send signal to Relay 2 to close and the projection screen is rolled down. When the presentation is ended, signal ceases on the HDMI input, so GPIO pins send signal to Relay 1 to close which results turning on the lights and sends signal to Relay 2 to open so projection screen returns to its enclosure.

ATTENTION! Please always check the electrical parameters of the devices what you want to control. The maximum current of one GPIO pin is 30 mA, the maximum total current for the six pins is 180 mA.

See the LDC settings for GPIO port in the [GPIO](#) section. See also the details about the Event Manager settings in the [Event Manager](#) section.

4.12. Further Built-in Features

4.12.1. Automatically Launched Actions – The Event Manager

The Event Manager feature means that the device can sense changes on its ports and is able to react according to the pre-defined settings. Lightware Device Controller contains a user-friendly software tool and allows to create Events by defining a Condition and an Action.

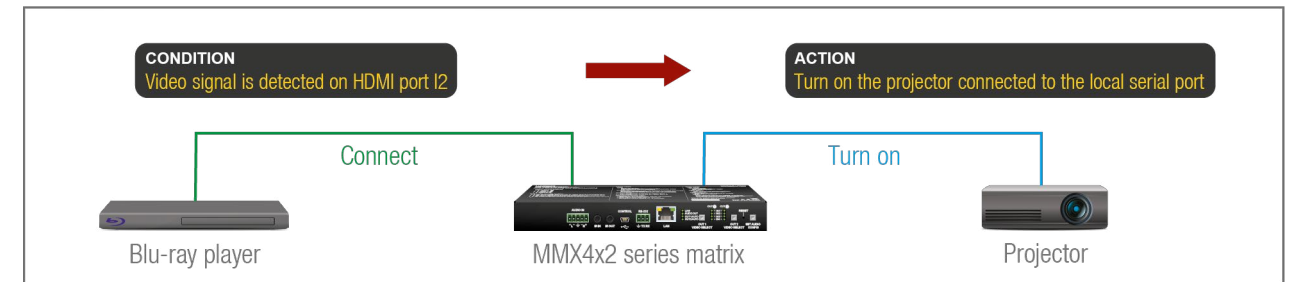

Event Manager Example

See more information about the settings in the [Event Manager](#) section.

4.12.2. Matrix Cloning – Configuration Backup and Restore

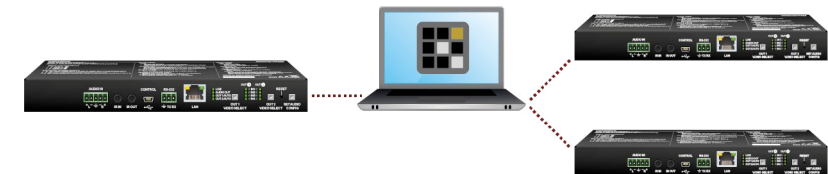

The device (configuration) cloning of MMX4x2 series matrix is a simple method that eliminates the need to repeatedly configure certain devices to have identical (non-factory) settings. If the devices are installed in the same type of system multiple times then it is enough to set up only one device to fit the user's needs and then copy those settings to the others, thus saving time and resources.

See more information about the settings in the [Configuration Cloning \(Backup Tab\)](#) section.

4.12.3. Advanced EDID Management

Factory Preset EDIDs

The factory EDIDs (F1-F120) are factory preprogrammed and cannot be modified. These are the most common resolutions. They are specially provided to force graphic cards to output only the exact pixel resolution and refresh rate.

Universal EDID allows multiple resolutions including all common VESA defined resolutions. The use of universal EDID is recommended for fast and easy system setup.

Sources and Destinations

The EDID memory consists of four parts:

- **Factory EDID** list shows the pre-programmed EDIDs (F1-F120).
- **Dynamic EDID** list shows the display device connected to the device's outputs. The unit stores the last display devices' EDID on either output, so there is an EDID shown even if there is no display device attached to the output port at the moment.
- **User memory** locations (U1 – U14) can be used to save custom EDIDs.
- **Emulated EDID** list shows the currently emulated EDID for the inputs. The source column displays the memory location that the current EDID was routed from.

The source reads the EDID from the Emulated EDID memory on the INPUT port. Any EDID from any of the User/Factory/Dynamic EDID lists can be copied to the user memory.

There are two types of emulation: **static** and **dynamic**.

- **Static EDID emulation:** an EDID from the Factory or User EDID list is selected. Thus, the Emulated EDID remains the same until the user emulates another EDID.
- **Dynamic EDID emulation:** it can be enabled by selecting D1 or D2 EDID memory. The attached monitor's EDID is copied to the input; if a new monitor is attached to the output, the emulated EDID changes automatically.

See more information about the settings in the [EDID Menu](#) section.

5

Software Control - Lightware Device Controller

The device can be controlled by a computer through Ethernet and RS-232 interfaces by the Lightware Device Controller (LDC). The software can be installed on a Windows PC or macOS. The application and the User's Manual can be downloaded from www.lightware.com.

- ▶ INSTALL AND UPGRADE
- ▶ RUNNING THE LDC
- ▶ ESTABLISHING THE CONNECTION
- ▶ CROSSPOINT MENU
- ▶ PORT PROPERTIES WINDOWS
- ▶ CEC TOOL
- ▶ DIAGNOSTIC TOOLS
- ▶ EDID MENU
- ▶ CONTROL MENU
- ▶ EVENT MANAGER
- ▶ SETTINGS MENU
- ▶ THE BUILT-IN MINIWEB
- ▶ CONFIGURATION CLONING (BACKUP TAB)
- ▶ ADVANCED VIEW WINDOW

5.1. Install and Upgrade

INFO: After the installation, the Windows and the Mac application has the same look and functionality. This type of the installer is equal with the Normal install in case of Windows and results in an updateable version with the same attributes.

Installation for Windows OS

Run the installer. If the User Account Control drops a pop-up message click **Yes**.

During the installation you will be prompted to select the type of the installation: **normal** and the **snapshot** install:

Normal install	Snapshot install
Available for Windows and macOS	Available for Windows
The installer can update only this instance	Cannot be updated
Only one updateable instance can exist for all users	More than one different version can be installed for all users

Comparison of installation types

ATTENTION! Using the Normal install as the default choice is highly recommended.

Installation for macOS

Mount the DMG file with double clicking on it and drag the LDC icon over the Applications icon to copy the program into the Applications folder. If you want to copy the LDC into another location just drag the icon over the desired folder.

Upgrading of LDC

Step 1. Run the application.

The **Device Discovery** window appears automatically and the program checks the available updates on Lightware's website and opens the update window if LDC updates are found.

The current and the update version number can be seen at the top of the window and they are shown in this window even with the snapshot install.

The **Update** window can also be opened by clicking the **About icon** and the **Update** button.

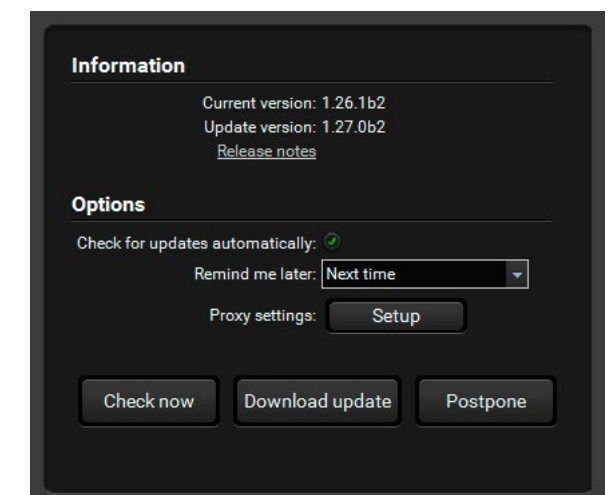

Step 2. Set the desired update setting in the **Options** section.

- If you do not want to check for the updates automatically, uncheck the **circle**, which contains the green tick.
- If you want to postpone the update, a reminder can be set with different delays from the **drop down list**.
- If the proxy settings traverse the update process, set the proper values then click the **OK** button.

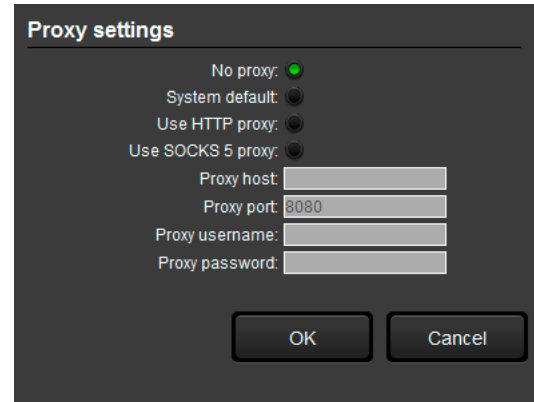

Step 3. Click the **Download update** button to start the upgrading.

The updates can be checked manually by clicking the **Check now** button.

5.2. Running the LDC

The common way to start the software is double-click on the LDC icon. But the LDC can be run by command line parameters as follows:

Connecting to a Device with Static IP Address

The LDC is connected to a device with the indicated static IP address directly; the Device Discovery window is not displayed. When the port number is not set, the default port is used: 10001 (LW2 protocol). For LW3 devices use the 6107 port number.

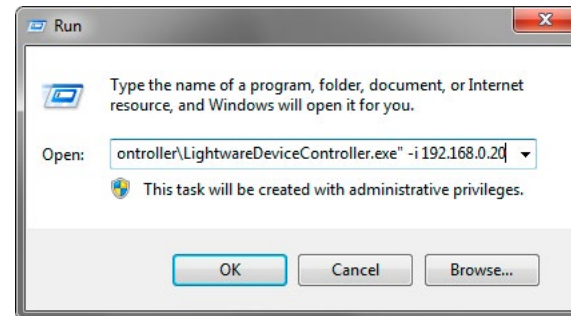

Format: LightwareDeviceController -i <IP_address>:<port>

Example: LightwareDeviceController -i 192.168.0.20:10001

Connecting to a Device via a Serial Port

The LDC is connected to a device with the indicated COM port directly; the Device Discovery window is not displayed. If no Baud rate is set the application will detect it automatically.

Format: LightwareDeviceController -c <COM_port>:<Baud>

Example: LightwareDeviceController -c COM1:57600

Adjusting the Zoom

The window can be zoomed to a specific value to fit to the resolution of the desktop (higher/lower). '1' is the default value (100%). *#new*

Format: LightwareDeviceController -z <magnifying_value>

Example: LightwareDeviceController -z 1.2

ATTENTION! The last set value is stored and applied when LDC is started without a parameter.

5.3. Establishing the Connection

Step 1. Connect the device to a computer via USB, RS-232, or Ethernet.

Step 2. Run the controller software; device discovery window appears automatically.

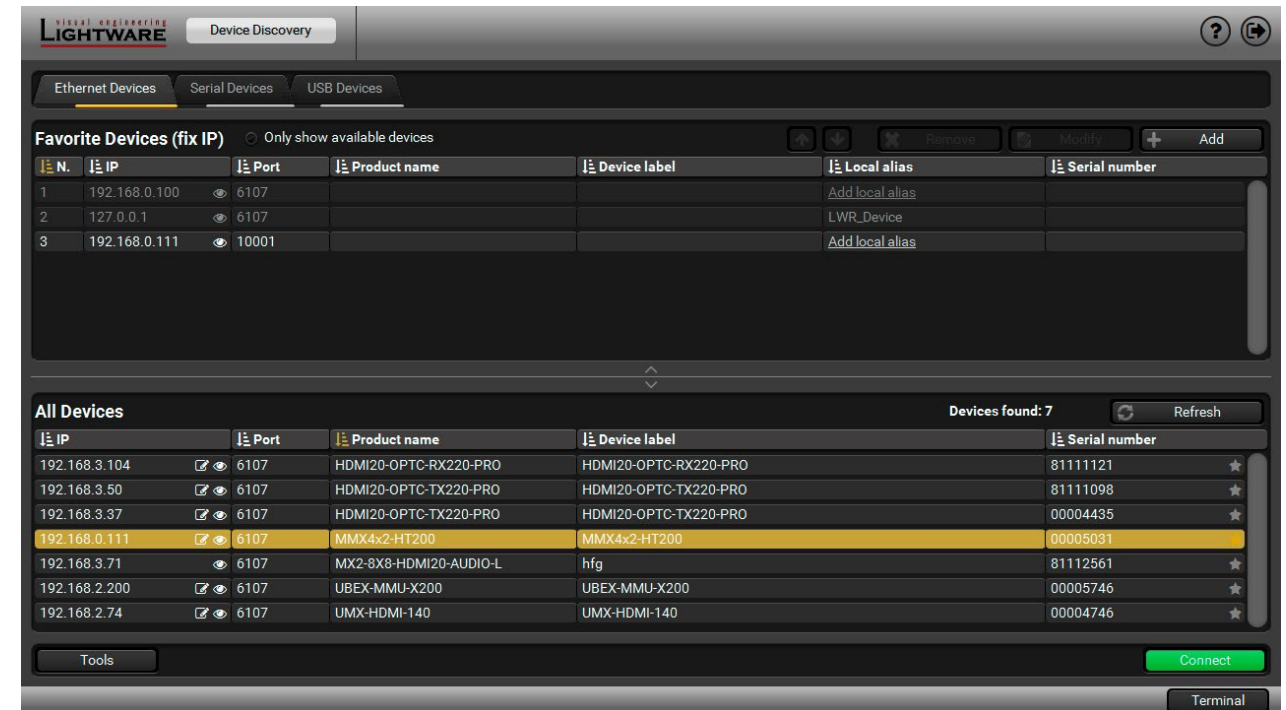

Device discovery window in LDC

Change IP Address

To modify IP address settings quickly it is not necessary to enter the device's settings/network menu, you can set them by clicking the pencil icon beside the IP address.

You can see the new settings only in this window.

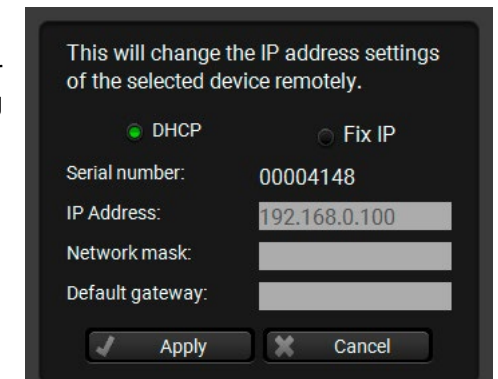

Identifying the Device

Clicking on the icon results the blinking of the status and crosspoint LEDs in green for 10 seconds. The feature helps to identify the device itself in the rack shelf. *#identifyme*

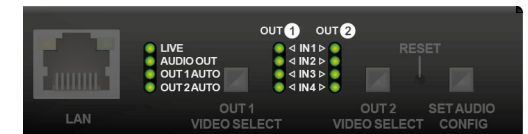

Step 3. Select the unit from the discovered Ethernet devices or under Serial devices; when the device is connected through RS-232 click on the **Query** button next to the desired serial port to display the device's name and serial number. Double click on the transmitter or select the device and click on the **Connect** button.

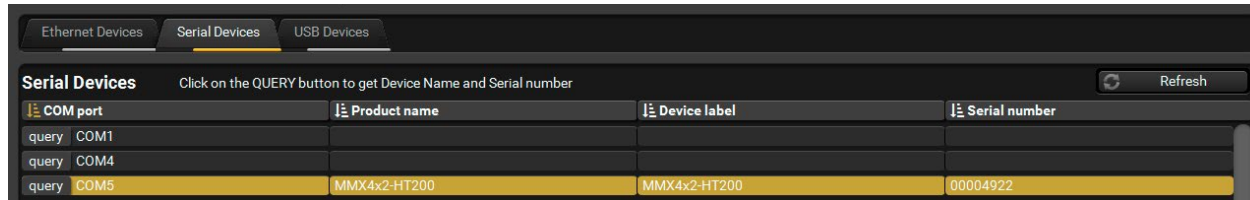

COM port	Product name	Device label	Serial number
query COM1			
query COM4			
query COM5	MMX4x2-HT200	MMX4x2-HT200	00004922

Serial devices tab in LDC

ATTENTION! Before the device is connected via the local RS-232 port, make sure that **Control mode** and **LW3 protocol** are set on the serial port.

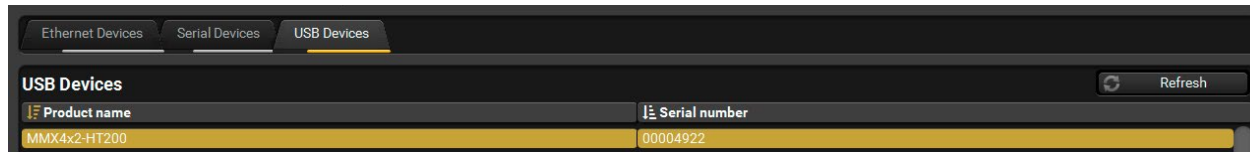

Product name	Serial number
MMX4x2-HT200	00004922

USB tab in LDC

5.4. Crosspoint Menu

DIFFERENCE: The appearance of the Crosspoint menu and the Audio port parameters show less features and settings in case of firmware package v1.0.0. #crosspoint #switch



- 1 **Main menu** The available menu items are displayed. The active one is showed with dark grey background color.
- 2 **Information ribbon** The label shows the device label which can be edited in the Settings menu - [Status](#) tab. Device discovery window can be displayed by clicking on this ribbon.
- 3 **Submenu selector** The audio and video crosspoint menu and the presets settings are available under the two tabs.
- 4 **Video input ports** Each tile represents a video input port ([TPS Video Input](#) / [HDMI Video Input](#)). The tile below the port shows the current crosspoint setting; if the port is switched to the output, the color of the tile is white, otherwise grey.

- 5 **Audio input ports** Each tile represents an audio input port. The A1 and A2 are logical audio ports, they mean the audio channel of the selected TPS/HDMI inputs. The A3 is the [Analog Audio Input](#).
- 6 **Advanced view** Displaying the [Advanced View Window](#), showing the Terminal window and the LW3 protocol tree.
- 7 **Audio output ports** HDMI and analog audio output ports; clicking on the O1/O2 tiles open the [Digital Audio Output](#) window; clicking on the O3 tiles open the [Analog Audio Output](#) window.
- 8 **Video output ports** HDMI video output ports; clicking on the tile opens the [HDMI Video Output](#) port properties window.

TIPS AND TRICKS: Hover the mouse cursor to the information ribbon; the **device label** and the **IP address** of the device will appear as a tooltip text.

Steps of Crosspoint Selection:

- Step 1.** Select the source from the video inputs (I1...I4) in the VIDEO section. It will specify the digital audio input selection as well.
- Step 2.** Select the audio source from the audio inputs (A1...A3). A1 and A2 digital audio inputs come from the previously selected HDMI video outputs. A3 is the analog audio input which can be embedded to the HDMI output.

TIPS AND TRICKS: Pre-programmed audio crosspoint settings can be selected by the **Set Audio Config** button, see the details in the [Set Audio Config Button](#) section.

The Port Diagram of MMX4x2-HT200

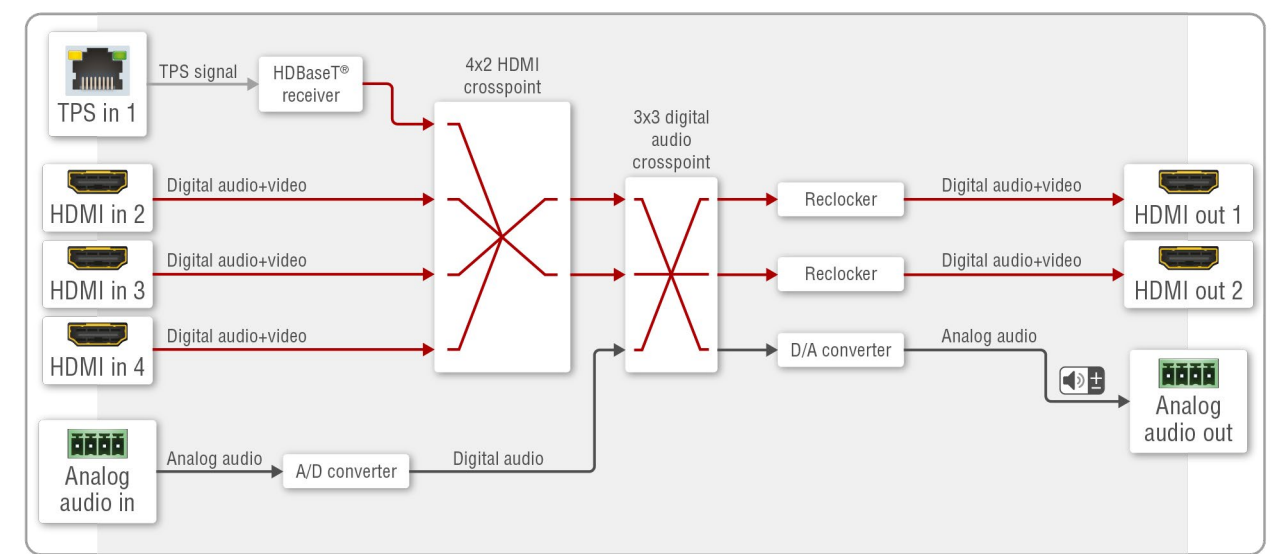

5.4.2. Presets Tab

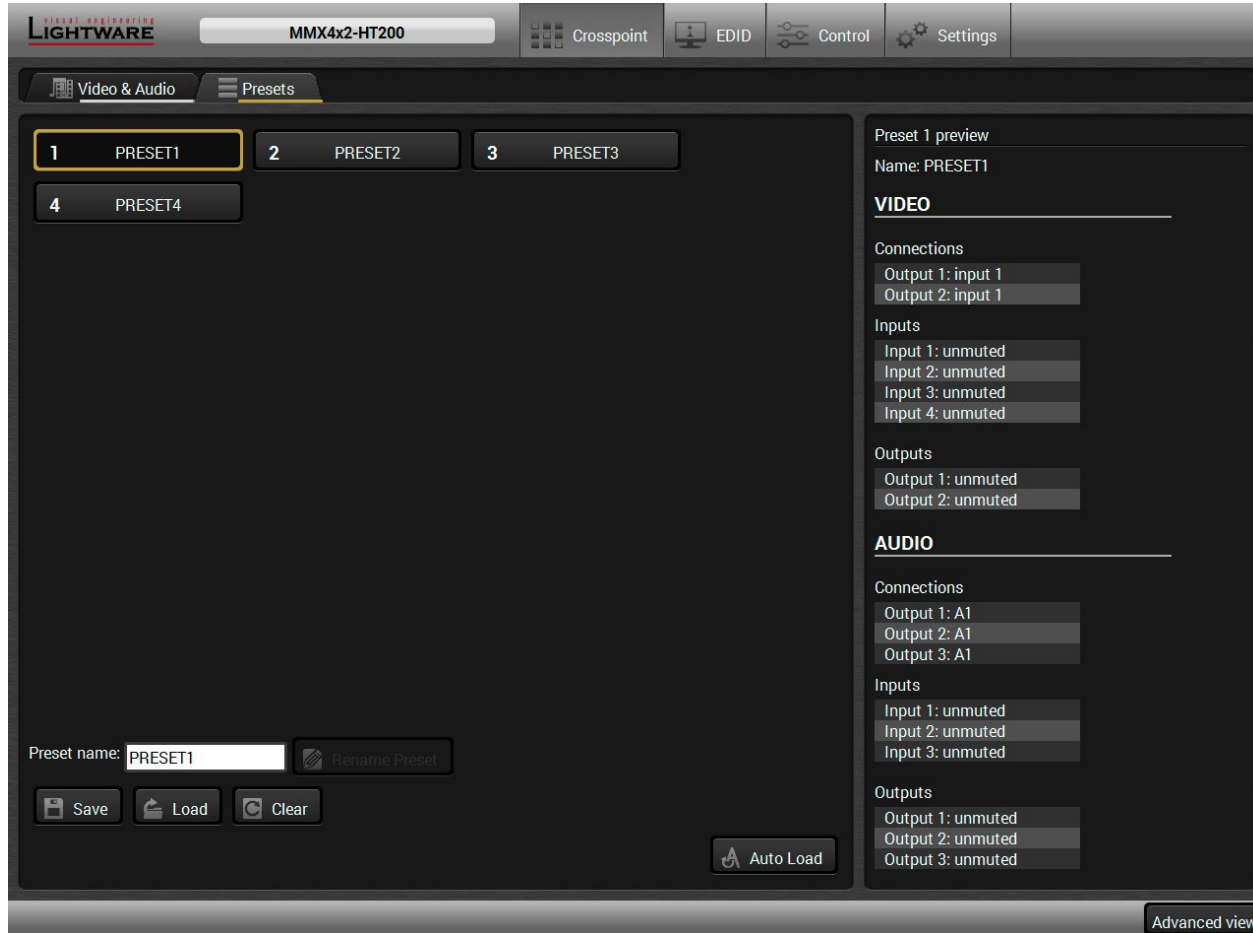

Preset tab in the Crosspoint menu

The recent crosspoint states and settings can be saved in four presets and loaded when it required. You can set a unique name with the **Rename Preset** button and save with the **Save** button. Previously saved presets can be recalled by the **Load** button and delete the settings by the **Clear** button.

Auto Load Mode Button

When the **Auto Load** button is highlighted with green, the mode is active. In this case, confirmation is not required: the selected preset is loaded immediately when the button is pressed.



5.4.3. Port Tiles

The colors of the port tiles and the displayed icons represent different states and information:

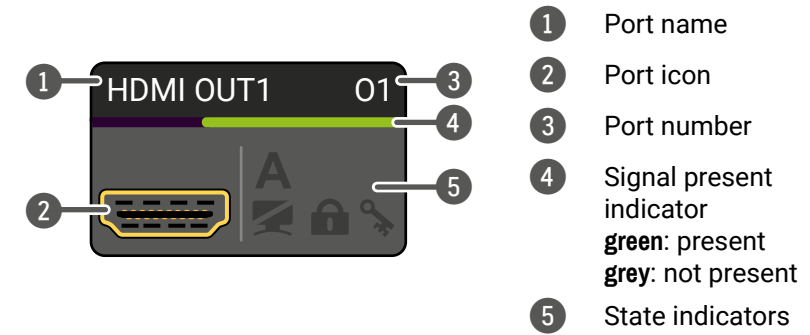

State Indicators #lock #unlock #mute #unmute

Following icons display different states of the port/signal:

Icon	Icon is grey	Icon is black	Icon is green
	Signal is not encrypted with HDCP	Signal is encrypted with HDCP	-
	Port is unmuted	Port is muted	-
	Port is unlocked	Port is locked	-
	Autoselect is disabled	-	Autoselect is enabled

5.5. Port Properties Windows

Clicking on the port tile opens the Port properties window. This section shows the available settings and status information by port types. `#lock` `#unlock` `#mute` `#unmute`

5.5.1. TPS Video Input

INFO: Only MMX4x2-HT200 model has TPS input port.

Clicking on the TPS video input port icon results opening the Port properties window. The most important information and settings are available from the panel.

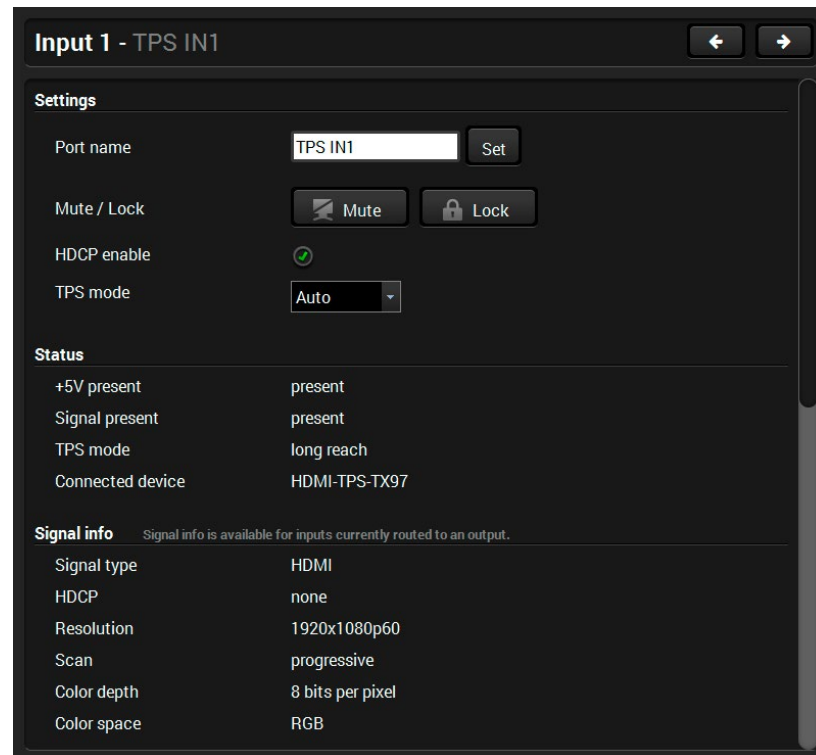

Port properties window of the TPS video input

Available settings and tools: `#signaltype`

- Mute/unmute the port;
- Lock/unlock the port;
- HDCP setting (enable / disable);
- TPS mode (see the details in the [TPS Interface](#) section); `#tpsmode`
- Send and receive Consumer Electronics Control (CEC) commands by the [CEC Tool](#),
- [Frame Detector](#);
- [No Sync Screen \(Test Pattern\)](#);
- Reloading factory default settings for the selected port.

5.5.2. HDMI Video Input

Clicking on the HDMI video input port icon results opening the Port properties window. The most important information and settings are available from the panel.

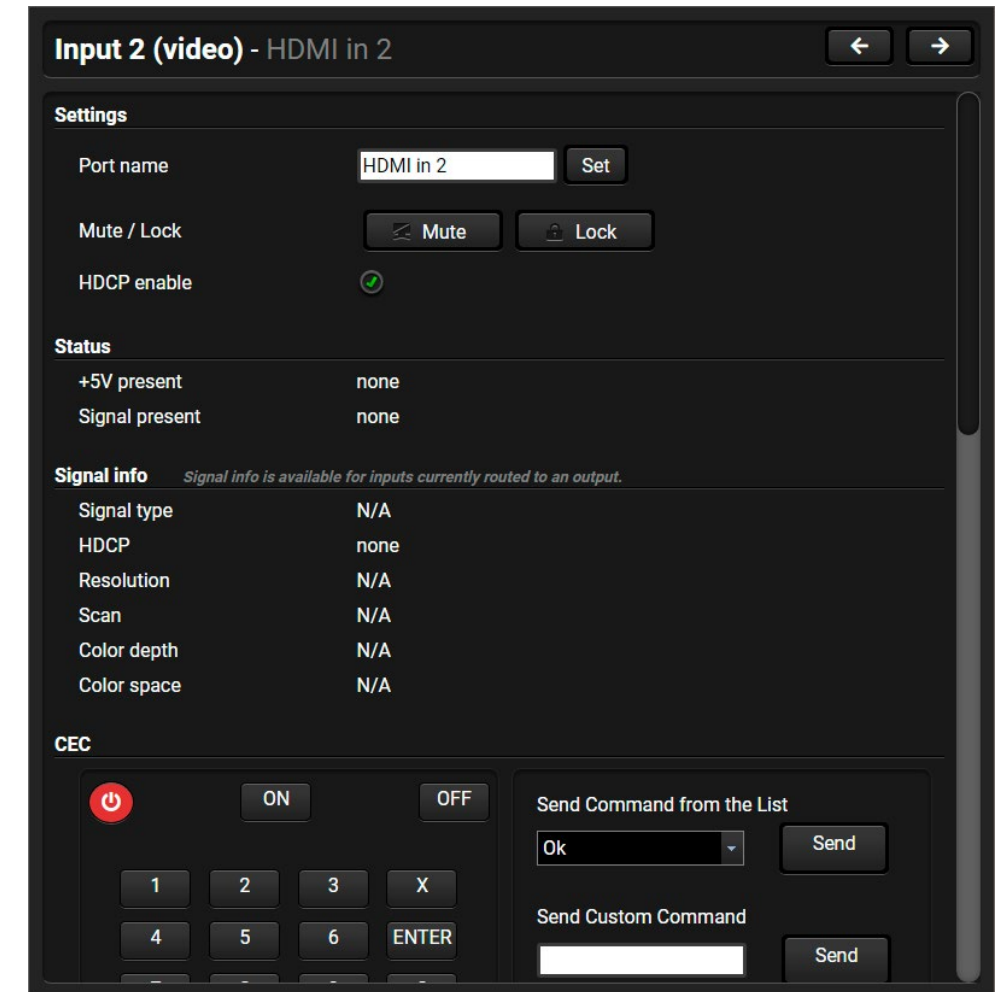

Port properties window of the HDMI video input

Available settings and tools: `#signaltype`

- Mute/unmute the port;
- Lock/unlock the port;
- HDCP setting (enable / disable);
- Send and receive Consumer Electronics Control (CEC) commands by the [CEC Tool](#),
- [Frame Detector](#);
- Reloading factory default settings for the selected port.

5.5.3. HDMI Video Output

Output 1 (video) - HDMI out 1

Settings

Port name: HDMI out 1 [Set]

Mute / Lock: [Mute] [Lock]

Signal type: Auto

HDCP mode: Auto

PWR5V mode: Always on

Autoselect

Autoselect: [Configure]

Test pattern

Mode: Off

Clock source: 480p

Pattern: Bar

Status

Monitor present: none

Hotplug detect: none

Signal present: none

Port properties window of the HDMI video output

Available settings and tools:

- Mute/unmute the port;
- Lock/unlock the port;
- **Autoselect** settings (see below)

- **Signal type:** Auto / DVI / HDMI - The outgoing signal format can be selected by a drop-down menu;
- **HDCP mode:** Auto / Always - The transmitter forces the source sent the signal without encryption if the content allows when Auto mode is selected; `#signaltype` `#hdcp`
- **Power 5V mode:** Auto / Always on / Always off - The setting lets the source and the sink devices be connected – independently from the transmitted signal;
- **No sync screen:** configuration settings of the test pattern. See more details in the [EDID Menu](#) section.
- [Frame Detector](#);
- Send and receive Consumer Electronics Control (CEC) commands by the [CEC Tool](#);
- Reloading factory default settings for the selected port.

Autoselect Settings `#autoselect`

Pay attention for the following settings for the proper operation of the Autoselect function:

- Be sure that no input is set to the same priority number;
- Be sure that all priority values are filled in (no empty space);
- Be sure that all inputs are enabled with the green pipe on the right side;
- Always click on the **Set priorities** button after the changes to launch the new settings.
- Set the Autoselect settings to **Enabled**;

Enable Autoselect

Enable Autoselect for the following inputs

HDMI in 1 HDMI in 2 HDMI in 3 HDMI in 4

Disable Autoselect

Operation mode

First detect

Last detect

Priority detect

HDMI in 1 HDMI in 2 HDMI in 3 HDMI in 4

0 1 2 3

Hint: 0 - highest priority 3 - lowest priority

[Apply]

(See more details about the feature in [The Autoselect Feature](#) section).

5.5.4. Digital Audio Input

A1 and A2 inputs are logical audio ports which are the audio channels of the selected HDMI input ports.

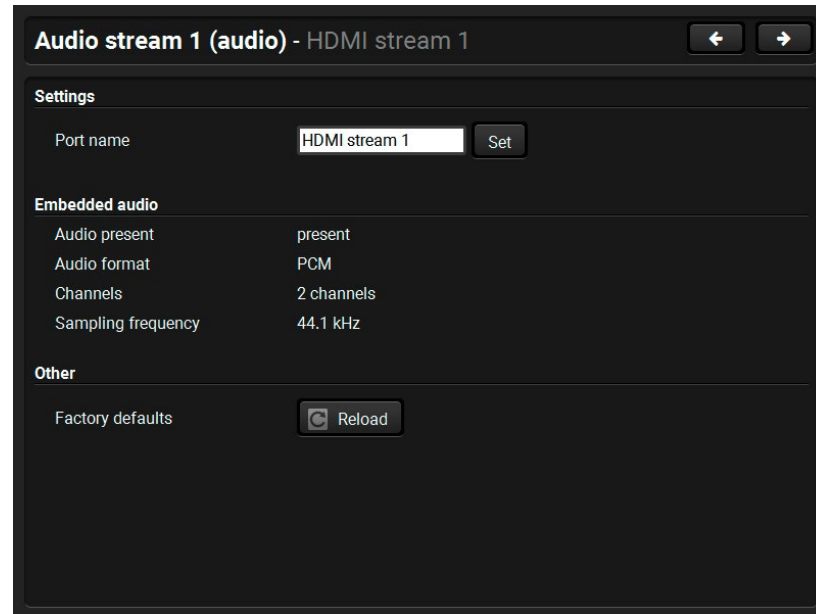

Port properties window of the A1 digital audio input

ATTENTION! If the TPS/HDMI video input port is muted/locked, the digital audio input port belongs to it will also be muted/locked.

5.5.5. Analog Audio Input

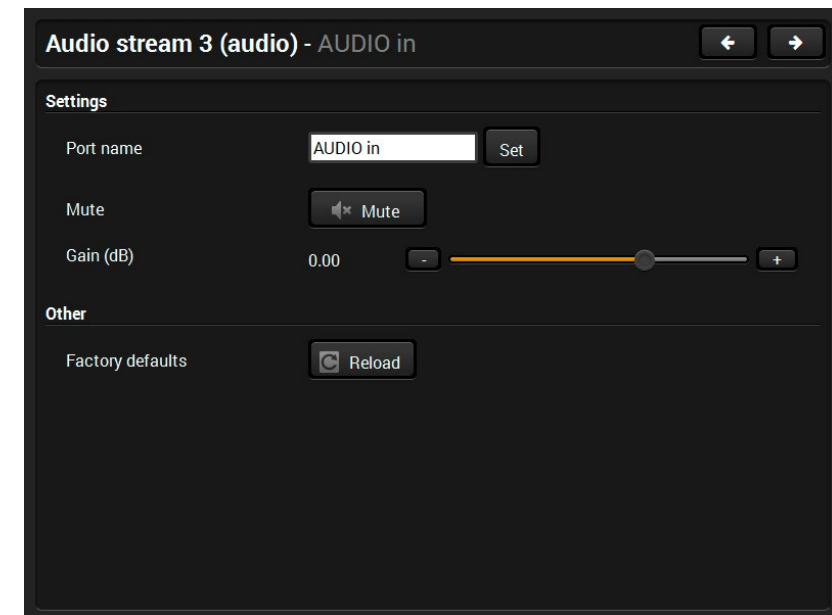

Port properties window of the analog audio input

Certain parameters of the analog audio input signal can be set as follows: *#analogaudio*

- Mute/unmute the port;
- Lock/unlock the port;
- Gain: -12 to 6 dB, in step 3 dB (default is 0 dB);
- Reloading factory default settings for the selected port.

5.5.6. Digital Audio Output

The port properties windows of the video and audio outputs are mirrored. For example the same window will be opened when you select the HDMI OUT1 on the Video or the Audio sections. The available settings can be found in the [HDMI Video Output](#) section.

5.5.7. Analog Audio Output

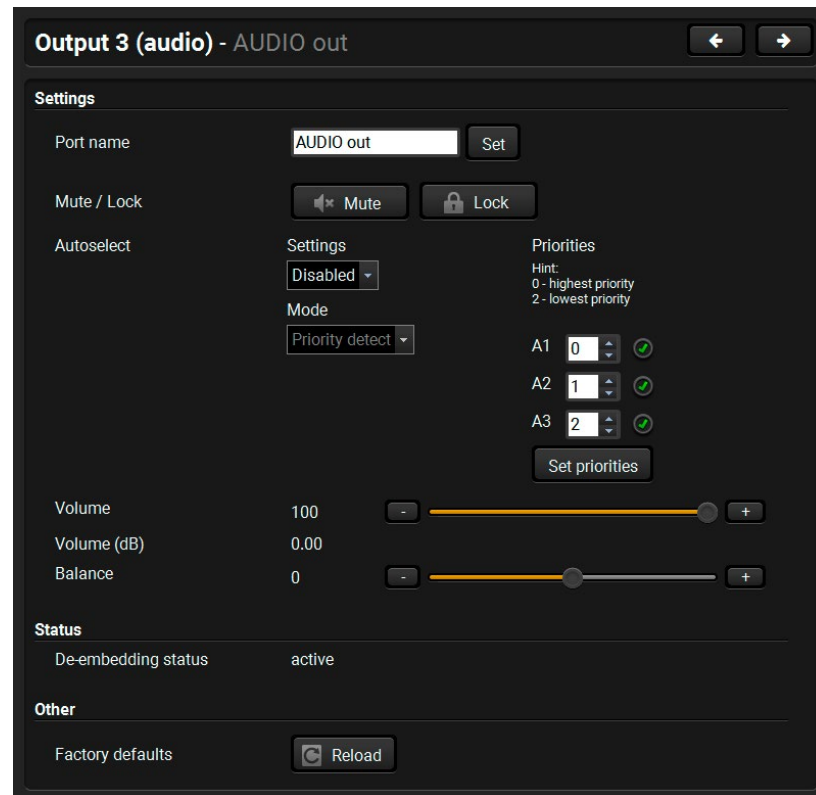

Port properties window of the analog audio output

Available settings: `#analogaudio` `#volume` `#balance`

- Mute/unmute the port;
- Lock/unlock the port;
- **Autoselect settings:** enable / disable, mode, and priorities. (See more details about the feature in [The Autoselect Feature](#) section);
- Volume: from 100 to 0%, in step 1% (0 dB to -57 dB, in step 0.375 dB (default is 0 dB));
- Balance: from -100 to 100, in step 1 (default is 0 = center);
- Reloading factory default settings for the selected port.

5.6. CEC Tool

The device is able to send and receive Consumer Electronic Control (CEC) commands. This feature is for remote control the source or sink device. CEC is a bi-directional communication via the HDMI cable.

#cec

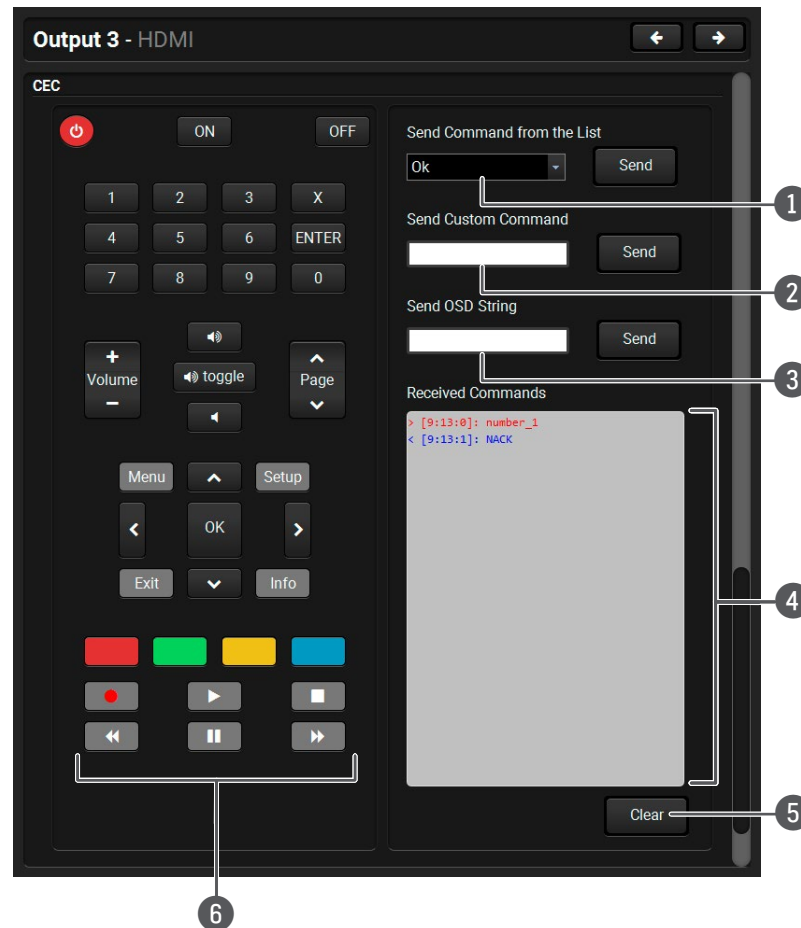

- 1 **Drop-down command list** Containing the basic CEC commands, most of them are displayed on the graphical interface, too (on the left side). Click on the **Send** button to execute sending the command.
- 2 **Custom command textbox** The text field is for sending hexadecimal commands to the source. The maximum allowed length is 30 characters (15 bytes). Click on the **Send** button to execute sending the command.
- 3 **OSD string textbox** Unique text can be shown on the sink device up to 14 characters. The send OSD (On-screen display) command textbox is the input field of the string. Alphanumeric characters, glyphs and space are accepted. Click on the **Send** button to execute the command.
- 4 **Received Command box** Displays all the sent (in red) CEC commands and the received answers (in blue) with a timestamp.
Legend of the received message:
`< [10:33:17] ACK`
 Answer for the acknowledged command.
`< [10:35:01] NACK`
 Answer for the not acknowledged command.
`< [10:33:17] IN PROGRESS`
 The command is being processed.
`< [10:33:17] FAILED`
 Answer for other failure.
`< [10:35:40] feature_abort_<*>`
 This is the most common answer from the third-party devices when the command is delivered, but the execution is refused. The cause of the refuse stands after 'feature_abort' expression.
- 5 **Clear button** Click on the **Clear** button to erase the content of the terminal window.
- 6 **CEC command button panel** This panel provides the quick and easy management of CEC commands. These buttons are pre-programmed with basic functions and sends commands towards the sink. The communication is displayed in the Received Command box. For the list of the commands see the [Sending CEC Commands](#) section. Both the layout and functionality are similar to the design of a remote control.

It can occur that the third-party device can receive, but not execute the command because it is not supported by the product. Check the accepted commands in the documentation of the device.

INFO: The first 2x2 bit of the CEC commands contains identification data of the source and destination address. In this case that is always 40.

ATTENTION! Make sure that the controlled unit is CEC-capable and this function is enabled.

5.7. Diagnostic Tools

5.7.1. Frame Detector

The ports can show detailed information about the signal like blanking intervals and active video resolution. This feature is a good troubleshooter if compatibility problems occur during system installation. To access this function, open the port properties window and click on **Frame detector** button.

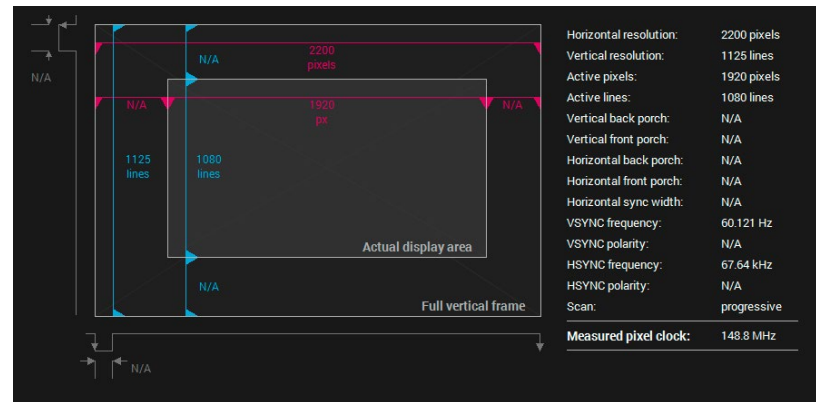

Frame detector window

Lightware's Frame Detector function works like a signal analyzer and makes possible to determine the exact video format that is present on the port, thus helps to identify many problems. E.g. actual timing parameters may differ from the expected and this may cause some displays to drop the picture.

Frame Detector measures detailed timings on the video signals just like a built-in oscilloscope, but it is much more easy to use. Actual display area shows the active video size (light gray). Dark gray area of the full frame is the blanking interval which can contain the info frames and embedded audio data for HDMI signals. Shown values are measured actually on the signal and not retrieved only from the HDMI info frames.

`#diagnostic` `#framedetector`

5.7.2. No Sync Screen (Test Pattern)

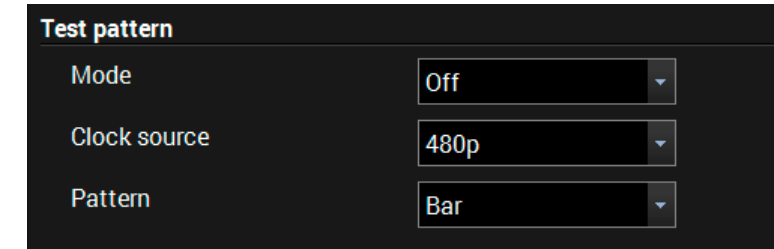

Test pattern options in the port properties window of the HDMI output

The No sync screen feature generates an image which can be displayed when there is no incoming signal on the port. The following settings can be set for the Test Pattern function:

Mode `#nosyncscreen` `#testpattern`

- **On:** the video output port always transmits the test pattern.
- **No signal:** the video output port transmits the test pattern if there is no incoming signal on the selected input port.
- **Off:** the test pattern function is disabled, the video output port transmits the video signal of the selected input port.

Clock Source

- 480p
- 576p
- Original video signal

Pattern

- Red
- Green
- Blue
- Black
- White
- Ramp
- Chess
- Bar
- Cycle



5.7.3. Cable Diagnostics

DIFFERENCE: This tool is available for MMX4x2-HT200 model only.

The cable diagnostics is a useful tool to determine any cable-related issue in case of TPS connection. The estimated cable length and the quality of the link are measured periodically and the diagnostic window shows the values in real-time. If the green bars hit the first line in the middle they turn into red. It means the number of the errors – during the extension – is higher than recommended. The link might be alive but recovering of the received data is not guaranteed. *#cablediagnostics*

INFO: Each bar represents a differential line in the CATx cable. The inappropriate termination of the cable usually causes high error rates. Check the cable terminations or change the cable.

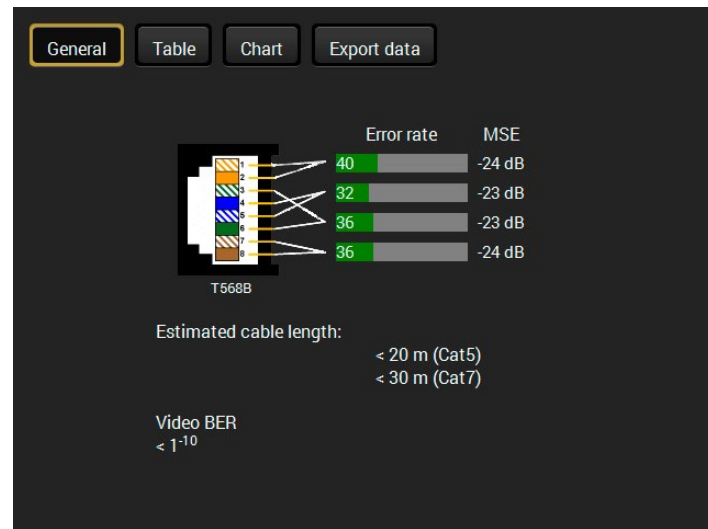

Reference Values

Value	Explanation
$1^{-10} - 1^{-9}$	Excellent image quality
1^{-8}	Minor error, not recognizable by eyes
1^{-7}	Sometimes recognizable flash on a special test pattern
1^{-6}	Small noise can be seen
1^{-5}	Easy to recognize image error
1^{-4}	Bad image quality

Above displayed “Video BER $< 1^{-10}$ ” value means that on average there is 1 bad pixel after 10^{10} pixels, which means the number of the bit errors is about 1 pixel in every 80 seconds.

INFO: You can find more details about maximum twisted pair cable distances in the [Mechanical Drawings](#) section.

Table and Chart Views

Cable diagnostics can be displayed in advanced modes as well. Two ways are available: **table view** and **chart view**. Data can be exported to a file on clicking on the **Export data** button.

Date	MSE #1	MSE #2	MSE #3	MSE #4	Error rate #1	Error rate #2	Error rate #3	Error rate #4	Cable length
2016-11-12 09:57:23	-24	-22	-22	-22	28	52	32	34	< 20
2016-11-12 09:57:24	-24	-22	-22	-22	28	52	32	34	< 20
2016-11-12 09:57:25	-24	-22	-23	-23	28	46	30	34	< 20
2016-11-12 09:57:26	-24	-22	-22	-22	26	44	30	36	< 20
2016-11-12 09:57:27	-24	-22	-22	-22	26	44	30	36	< 20
2016-11-12 09:57:28	-24	-22	-23	-22	26	46	32	38	< 20
2016-11-12 09:57:29	-24	-22	-23	-22	26	46	32	38	< 20
2016-11-12 09:57:30	-24	-22	-23	-22	26	46	32	38	< 20

Table view of cable diagnostics

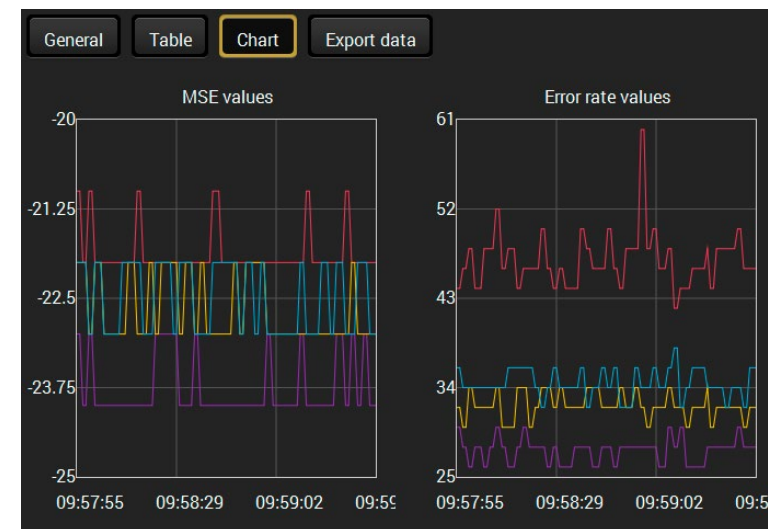
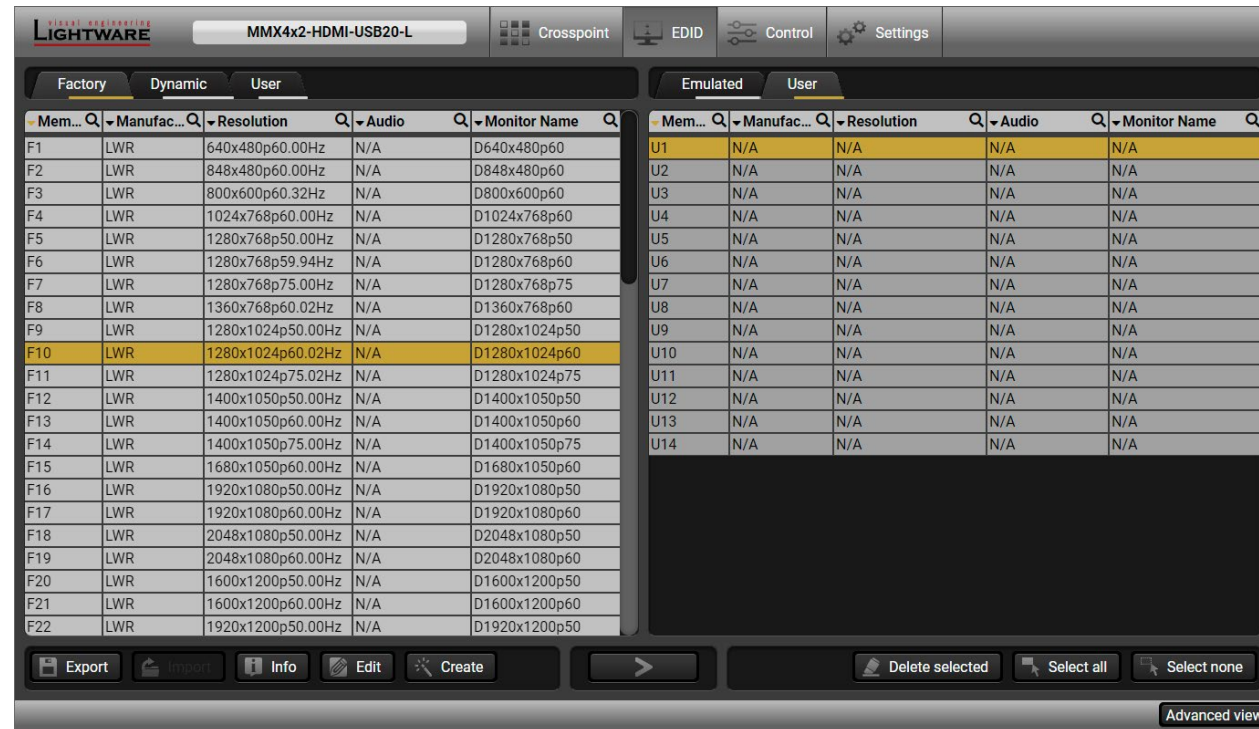

Chart view of cable diagnostics









5.8. EDID Menu

Advanced EDID Management can be accessed by selecting the EDID menu. There are two panels: left one contains Source EDIDs, right one contains Destination places where the EDIDs can be emulated or copied.

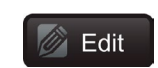

EDID menu

Control Buttons

-  Export: Exporting an EDID (save to a file)
-  Import: Importing an EDID (load from a file)
-  Info: Display EDID Summary window
-  Edit: Opening Advanced EDID Editor with the selected EDID
-  Create: Opening Easy EDID Creator
-  Transfer button: executing EDID emulation or copying
-  Delete selected: Deleting EDID (from User memory)
-  Select All: Selecting all memory places in the right panel
-  Select none: Selecting none of the memory places in the right panel

#edid

5.8.1. EDID Operations

Changing Emulated EDID

- Step 1.** Choose the desired **EDID list** on the source panel and select an **EDID**. 
- Step 2.** Press the **Emulated** button on the top of the Destination panel.
- Step 3.** Select the desired **port** on the right panel (one or more ports can be selected); the EDID(s) will be highlighted with a yellow cursor.
- Step 4.** Press the **Transfer** button to change the emulated EDID.

Learning an EDID

The process is the same as changing the emulated EDID; the only difference is the Destination panel: press the **User** button. Thus, one or more EDIDs can be copied into the user memory either from the factory memory or from a connected sink (Dynamic).

Exporting an EDID

ATTENTION! This function is working on Windows and macOS operating systems and under Firefox or Chrome web browsers only.

Source EDID can be downloaded as a file (*.bin, *.dat or *.edid) to the computer.

- Step 1.** Select the desired **EDID** from the Source panel (line will be highlighted with yellow). 
- Step 2.** Press the **Export** button to open the dialog box and save the file to the computer.

Importing an EDID

Previously saved EDID (*.bin, *.dat or *.edid file) can be uploaded to the user memory:

- Step 1.** Press the **User** button on the top of the Source panel and select a **memory** slot. 
- Step 2.** Press the **Import** button below the Source panel.
- Step 3.** Browse the file in the opening window then press the **Open** button. Browsed EDID is imported into the selected User memory.

ATTENTION! The imported EDID overwrites the selected memory place even if it is not empty.

Deleting EDID(s)

The EDID(s) from User memory can be deleted as follows:

- Step 1.** Press **User** button on the top of the Destination panel. 
- Step 2.** Select the desired **memory** slot(s); one or more can be selected ("Select All" and "Select None" buttons can be used). The EDID(s) will be highlighted with yellow.
- Step 3.** Press the **Delete selected** button to delete the EDID(s).

5.8.2. EDID Summary Window

Select an EDID from Source panel and press **Info** button to display EDID summary.



- General
- Power Management
- Gamma / Colors
- Established Timings
- Standard Timings
- Preferred Timing Mode
- 2nd Descriptor Field
- 3rd Descriptor Field
- 4th Descriptor Field
- CEA General
- CEA Video
- CEA Audio
- CEA Speaker Allocation
- CEA HDMI
- CEA Colorimetry
- CEA Detailed Timing Descriptors

General

EDID version: 1
 EDID revision: 3
 Manufacturer ID: SAM (Samsung Electric Company)
 Product ID: 8E09
 Monitor serial number: Not present
 Year of manufacture: 2012
 Week of manufacture: 9
 Signal interface: Digital
 Separate Sync H&V: -
 Composite sync on H: -
 Sync on green: -
 Serration on VS: -
 Color depth: Undefined
 Interface standard: Not defined
 Color spaces: RGB 4:4:4 & YCrCb 4:4:4
 Aspect ratio: 0.56
 Display size: 52 cm X 29 cm

EDID summary window

5.8.3. Editing an EDID

Select an EDID from Source panel and press **Edit** button to display Advanced EDID Editor window. The editor can read and write all descriptors, which are defined in the standards, including the additional CEA extensions. Any EDID from the device's memory or a saved EDID file can be loaded into the editor. The software resolves the raw EDID and displays it as readable information to the user. All descriptors can be edited, and saved in an EDID file, or uploaded to the User memory. For more details about EDID Editor please visit our website (www.lightware.com) and download the EDID Editor Application note.



- Basic EDID
- Vendor / Product Information
- Display Parameters
- Power Management and Features
- Gamma / Color and Established Timings
- Standard Timings
- Preferred Timing Mode
- 2nd Descriptor Field
- 3rd Descriptor Field
- 4th Descriptor Field
- CEA Extension
- General
- Video Data
- Audio Data
- Speaker Allocation Data
- HDMI
- Colorimetry
- Detailed Timing Descriptor #1
- Detailed Timing Descriptor #2
- Detailed Timing Descriptor #3
- Detailed Timing Descriptor #4
- Detailed Timing Descriptor #5
- Detailed Timing Descriptor #6
- Save EDID

EDID Byte Editor

	0	1	2	3	4	5	6	7	8	9
0	00	FF	FF	FF	FF	FF	FF	00	4C	2D
10	8E	09	00	00	00	00	09	16	01	03
20	80	34	1D	78	0A	7D	D1	A4	56	50
30	A1	28	0F	50	54	BD	EF	80	71	4F
40	81	C0	81	00	81	80	95	00	A9	C0
50	B3	00	01	01	02	3A	80	18	71	38
60	2D	40	58	2C	45	00	09	25	21	00
70	00	1E	66	21	56	AA	51	00	1E	30
80	46	8F	33	00	09	25	21	00	00	1E
90	00	00	00	FD	00	18	4B	1A	51	17
100	00	0A	20	20	20	20	20	20	00	00
110	00	FC	00	54	32	34	42	33	30	31
120	0A	20	20	20	20	20	01	6C		

EDID Editor window

5.8.4. Creating an EDID - Easy EDID Creator

Since above mentioned Advanced EDID Editor needs more complex knowledge about EDID, Lightware introduced a wizard-like interface for fast and easy EDID creation. With Easy EDID Creator it is possible to create custom EDIDs in four simple steps. By clicking on the **Create** button below Source panel, **Easy EDID Creator** is opened in a new window. For more details about EDID Editor please visit our website (www.lightware.com) and download the EDID Editor Application note.

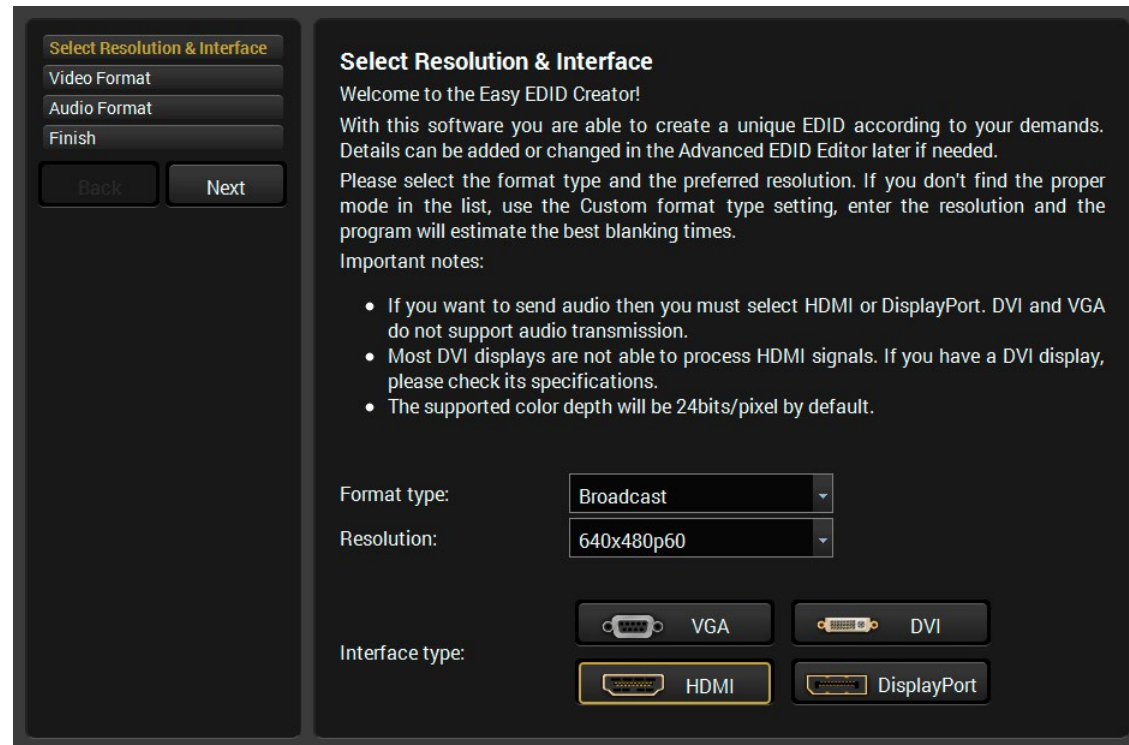

EDID Creator window

5.9. Control Menu

5.9.1. RS-232

DIFFERENCE: MMX4x2-HDMI-USB20-L model is assembled with two local RS-232 ports. TPS port can be found on MMX4x2-HT200 model only.

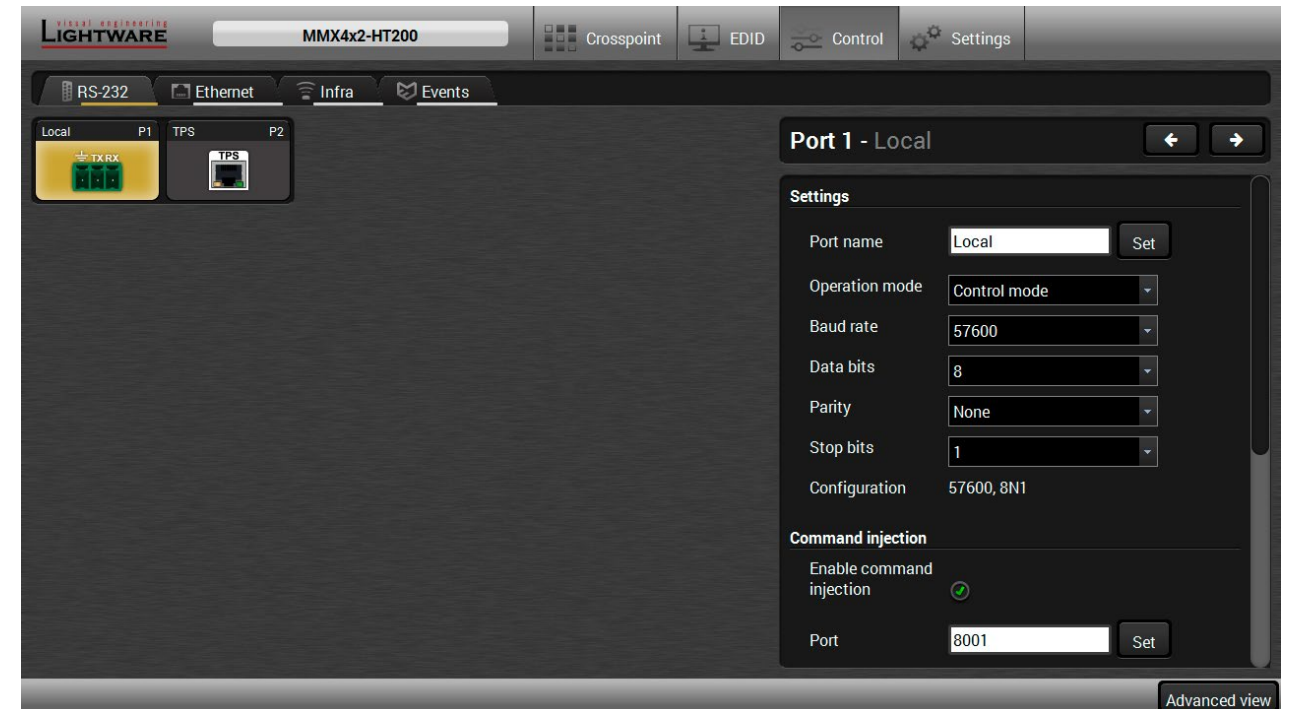

RS-232 tab in Control menu

The following settings and functions are available (both on local and TPS serial ports):

- Operation mode: Control, Command Injection, or Disconnected (for more details about serial interface modes see the [RS-232 Serial Interface](#) section);
- Baud rate: 4800, 7200, 9600, 14400, 19200, 38400, 57600, 115200;
- Data bits: 8 or 9;
- Parity: None, Odd, or Even;
- Stop bits: 1, 1.5, or 2;
- Command injection: enable or disable; port number; `#commandinjection`
- Control protocol: LW2 or LW3; `#protocol` `#rs232` `#rs-232` `#serial`
- Message sending via serial port; `#message`
- Reloading factory defaults (see factory default settings in the [Factory Default Settings](#) section).

ATTENTION! If the matrix is connected to a TPS2 output board of a matrix frame, the RS-232 configuration settings (baud rate, data bits, e.t.c.) will not be changeable on the matrix side.

5.9.2. Ethernet

DIFFERENCE: MMX4x2-HDMI-USB20-L model has three RJ-45 connectors for Ethernet. TPS port can be found on MMX4x2-HT200 model only.

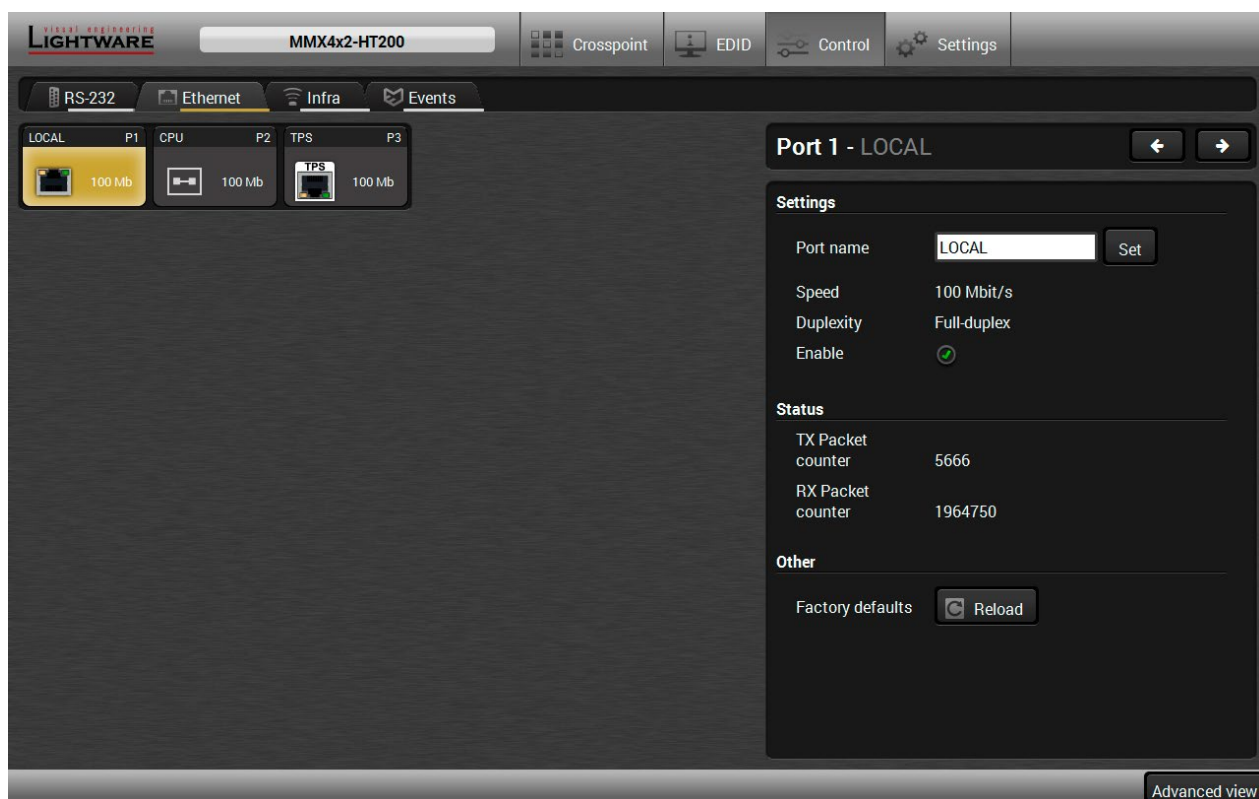

Ethernet tab in Control menu

Three ports are displayed in the Ethernet settings: Local, CPU, and TPS*. You can check the status of the Ethernet line by each ports: the speed and the duplexity of the connection.

The following settings are available for each ports:

- Enable / disable the port; **
- Reloading factory defaults.

* Only MMX4x2-HT200 model has TPS Ethernet port.

** CPU Ethernet port cannot be disabled.

5.9.3. GPIO

DIFFERENCE: This section refers to the MMX4x2-HDMI-USB20-L model only.

The GPIO port has 6 pins, which operate at TTL digital signal levels and can be controlled by LDC or protocol commands. Select a GPIO pin and under the Port settings section; the settings (pin direction and input level) are displayed on the port tiles as well. #gpio

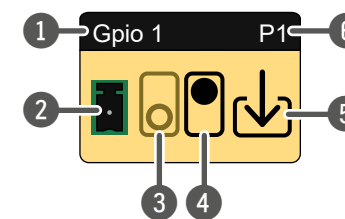
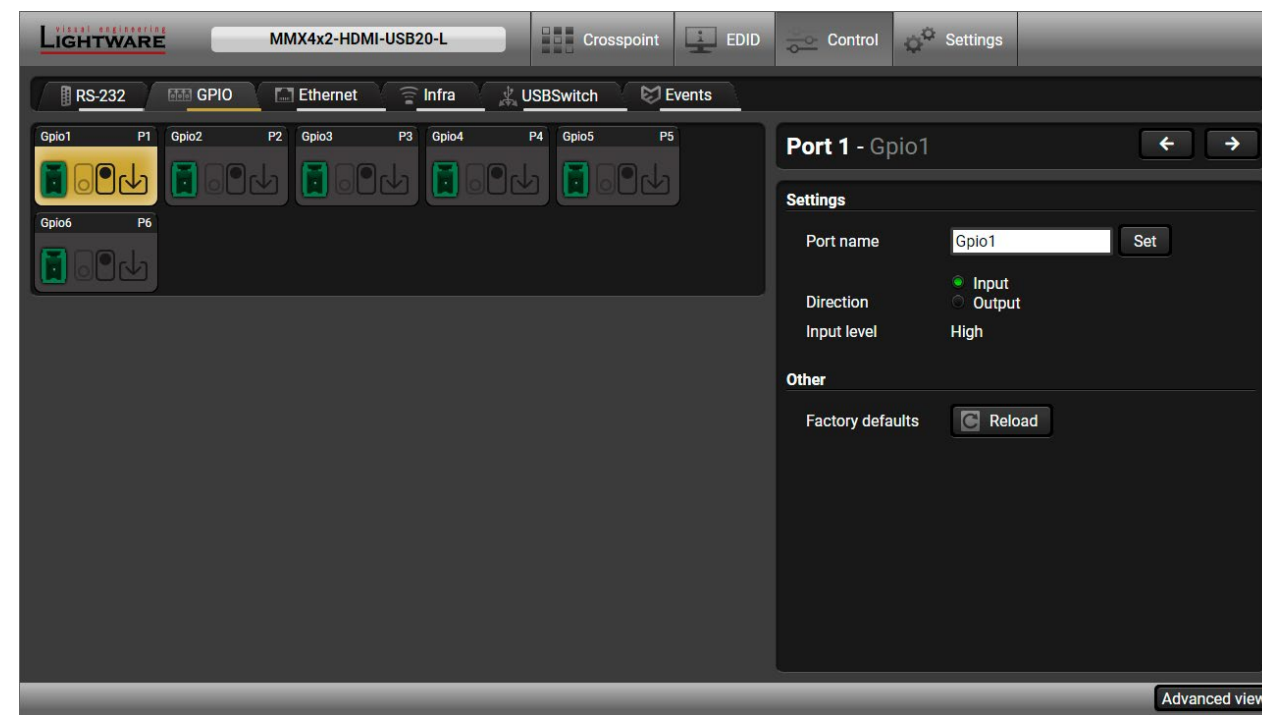

- 1 GPIO pin name
- 2 GPIO port icon
- 3 Low level indicator *
- 4 High level indicator *
- 5 Pin direction:
Input: down arrow
Output: up arrow
- 6 GPIO port number

* The black-highlighted symbol means the current setting.

INFO: Output level can be set only in case of setting the pin direction to Output. In case of input direction the output level setting and the Toggle button is not available.

For more details about GPIO interface see the [GPIO Interface](#) section.

5.9.4. Infra

ATTENTION! The device has no built-in Infrared receiver and transmitter. For the complete usage attach an IR emitter unit to the IR OUT and an IR detector unit to the IR IN connectors.

Infrared (IR) receiver and transmitter options can be found on this tab. There are three submenus available under it: **IR codes**, **Ports**, and **Clear all IR codes**.

IR Codes [#infra](#) [#infrared](#)

The user can set the name of the IR code, the fingerprint (hash), and the repeat timeout in ms, actions can be ordered to each IR code as well.

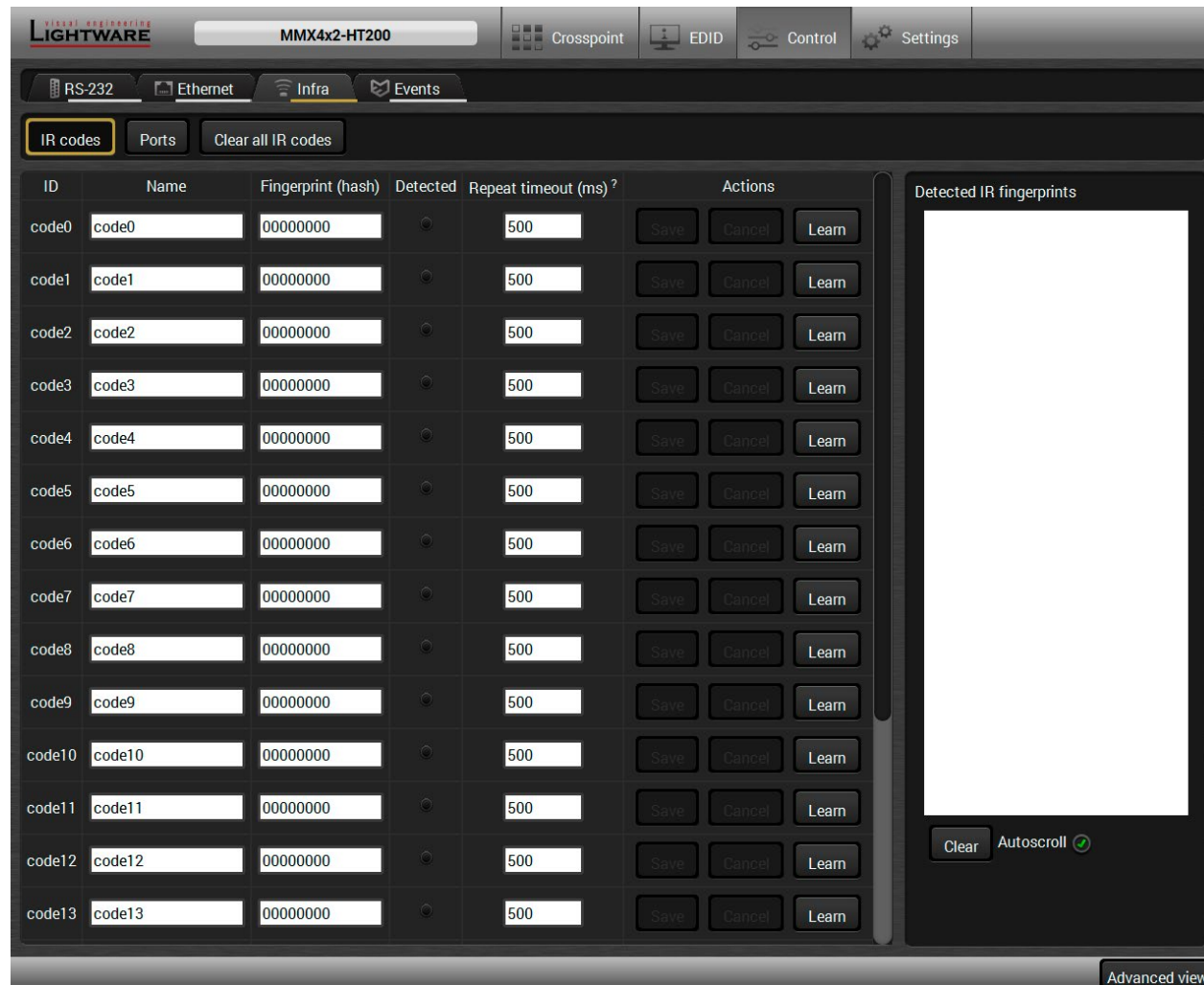

IR codes window in Control menu

Description	Function
ID	Code number.
Name	You can give an unique name for the desired code.
Fingerprint (hash)	Fingerprint code in pronto hexa format.
Detected	Indicator gives feedback about the given IR code is detected currently.
Repeat timeout (ms)	You can set a timeout to avoid the involuntary code recurrence.
Actions	Action buttons for the desired IR code: Save: saving the fingerprint. Cancel: canceling the fingerprint. Learn: learning the detected IR code.
Detected IR fingerprints	You can check the detected IR codes in this panel. Pushing Clear button deleting all current fingerprints and switch on or off the automatic scrolling with the Autoscroll pipe.

20 fingerprints can be stored in the device at the same time. Each of them can be ordered to an action in Event Manager. For more details about events see [Event Manager](#) section.

Learning IR Codes

- Step 1.** Connect the IR detector unit to the IR IN port of the receiver.
- Step 2.** Click on the **Learn** button.
- Step 3.** Turn the remote controller to the IR detector. A pop-up window appears in LDC - press your remote button to learn.
- Step 4.** Once the code is received, a new window pops up in LDC - learning completed. Click **OK** to continue.
- Step 5.** Optionally type a unique name for the code in the **Name** text box. The default name is code#, e.g. code0.

Ports

User can set the name and command injection port to each sources and destinations. For more details about IR interface see the [IR Interface](#) section.

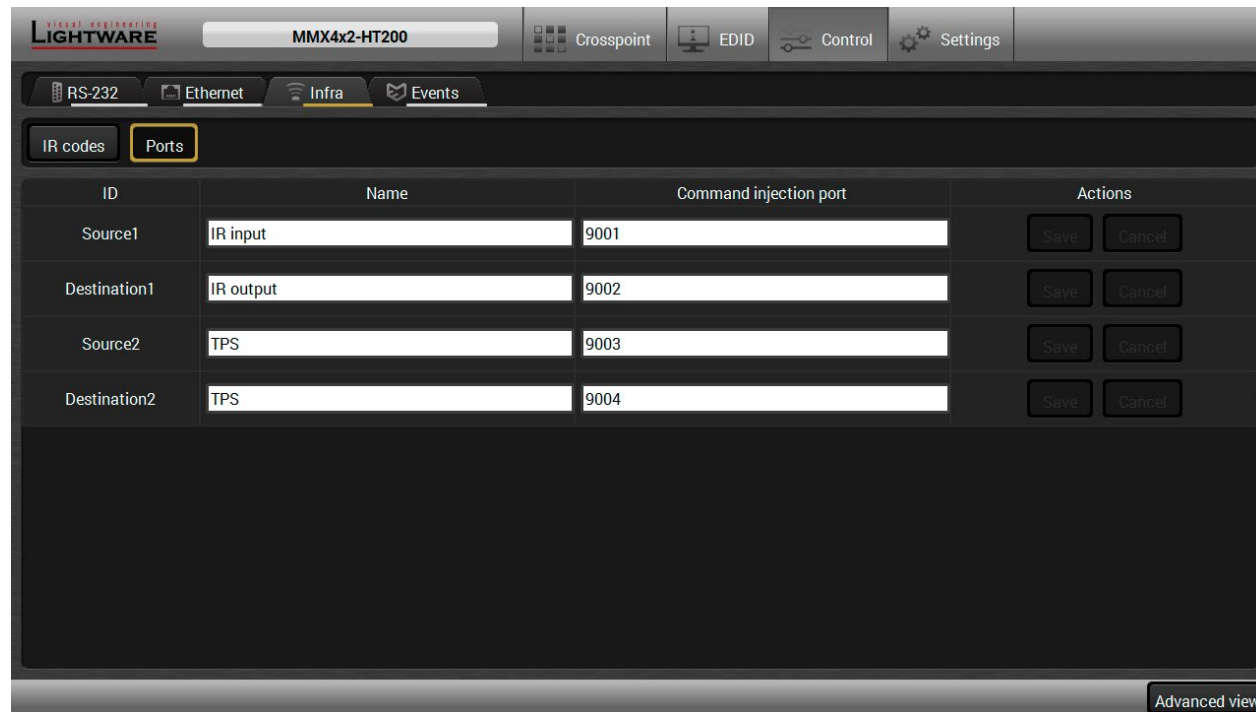

Infra tab - Ports window

Clear all IR codes

Clicking on the button results deleting all stored IR fingerprints.

5.9.5. USBSwitch

DIFFERENCE: This section refers to the MMX4x2-HDMI-USB20-L model only. *#new*

Certain settings of the connected USB devices are available on this page:

- 1 Select the desired USB host device (computer) from the list.
- 2 When this option is enabled, the 5V power is turned off for 2 seconds towards the USB peripherals when the USB host is switched.
- 3 The symbols show if a USB host device is connected to the port.
- 4 When the option is enabled the device gets the 5V over the USB-A port.

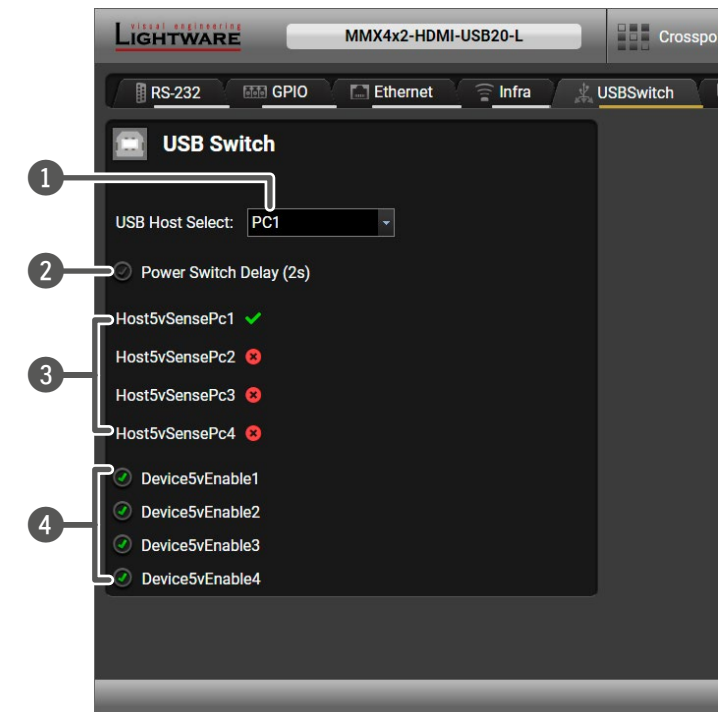

About the Power Switch Delay

After switching between the hosts, certain connected USB peripherals need to be reset to operate properly. Enable the power switch delay function, then the 5V power of all the devices is off for 2 seconds. This forces the devices to restart, thus, the user does not have to physically unplug/re-plug the connected USB device.

#usb

5.10. Event Manager

The feature means that the device can sense changes on its ports and able to react according to the pre-defined settings. The development idea of the Event manager is based on users' feedbacks. In many cases internal events (such as signal present or HDCP active) are necessary to display but it is not easy when the device is hard to access (e.g. built under the desk). For more details and examples about Event Manager please visit our website (www.lightware.com) and download **Event Manager user's guide** in the Downloads section.



The Event manager can be configured to perform an action if a condition has been detected. E.g. the desired setup is that after a certain type of signal has been detected on I1 port, the port has to be switched to O1. The settings can be done via the LDC in the Control/Events tab, or by LW3 protocol commands. Configurable events number depends on the device what you are using actually.

Numerous new ideas and requests have been received in connection with the features and settings of the Event manager since the first release. Therefore, the user interface has been re-designed and many new functions implemented. The Event editor can be opened by pressing the Edit button at each Event.

There is a **grey bar** on the left of the Event panel in each line. If a condition and an action are set and the Event is enabled, the bar is displayed in **green**. #eventmanager

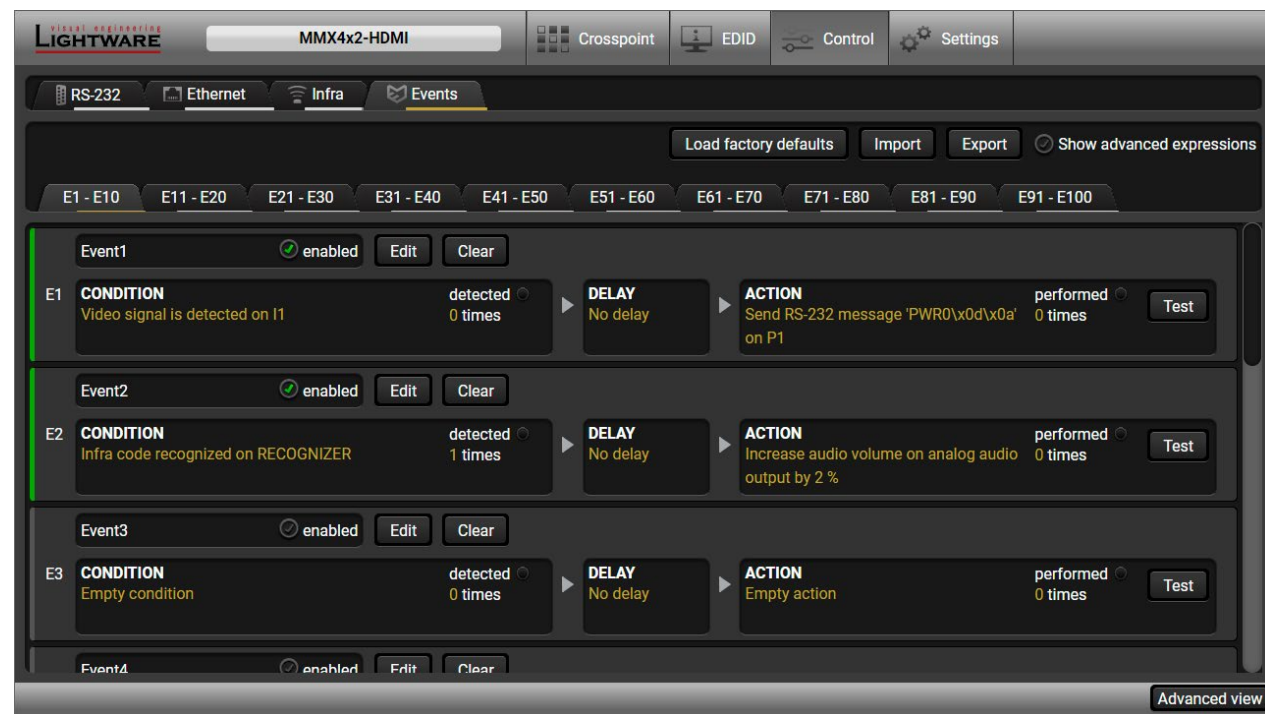

Control menu, Event Manager tab

5.10.1. The Event Editor

Press the **Edit** button in the desired Event line to open the Event editor window.

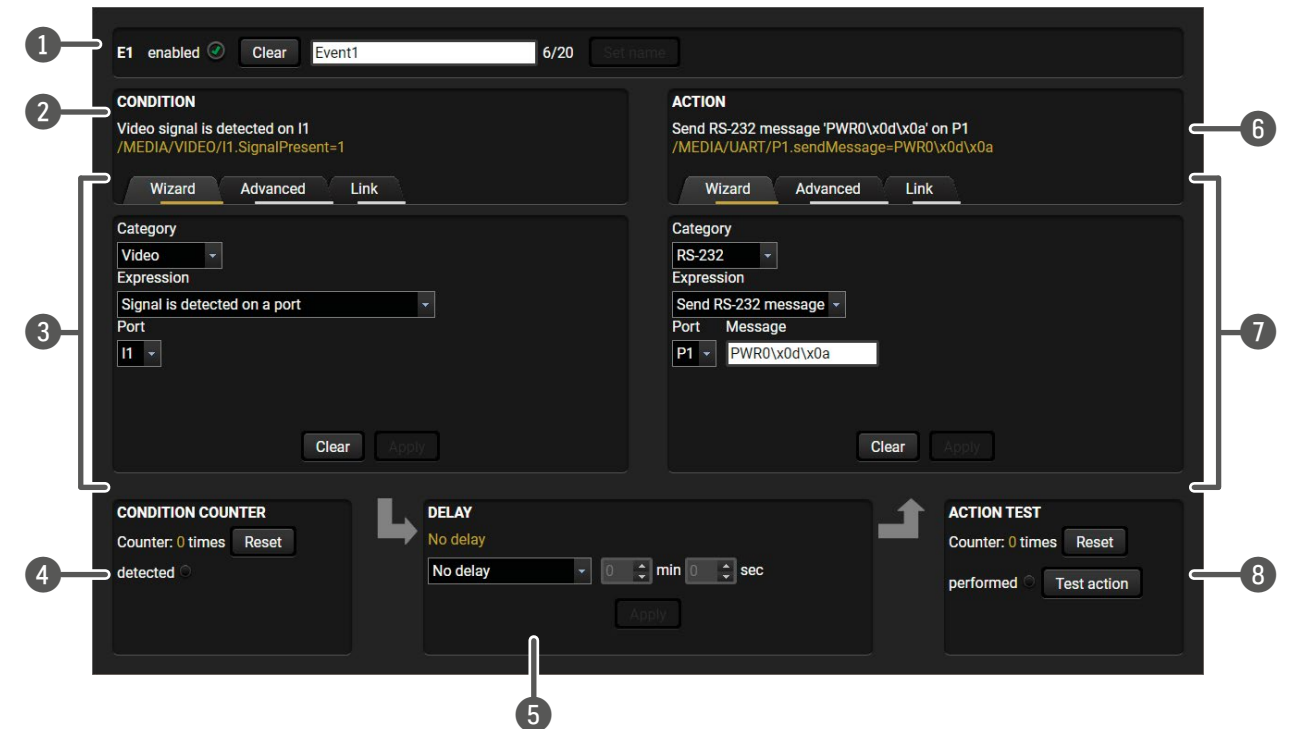

- 1 **Event header** The name of the Event is displayed. Type the desired name and press the Set name button. The Event can be cleared by the Clear button. Use the tick mark to enable/disable the Event.
- 2 **Condition header** If the condition is set, the description (white colored text) and the exact LW3 protocol expression (yellow colored text) can be seen. If the advanced mode was used the description is "Custom condition".
- 3 **Condition panel** The Wizard, the Advanced or the Link tool is available to set the condition. The parameters and settings are displayed below the buttons.
- 4 **Condition counter** The set condition can be tested to see the working method in the practice.
- 5 **Delay settings** The action can be scheduled to follow the condition after the set time value.
- 6 **Action header** If the action is set, the description (white colored text) and the exact LW3 protocol expression (yellow colored text) can be seen. If the advanced mode was used the description is "Custom action".
- 7 **Action panel** The Wizard, the Advanced or the Link tool is available to set the action. The parameters and settings are displayed below the buttons.
- 8 **Action test** The set action can be tested to see the working method in the practice.

5.10.2. Create or Modify an Event

Wizard Mode

The wizard mode lists the most common conditions and actions, so the user does not have to look for LW3 nodes and properties.

- Step 1.** Click on the **Edit** button of the desired Event; the **Event editor** is displayed.
- Step 2.** The wizard mode is displayed as default. Select the desired **Category** first (e.g. Audio or Video).
- Step 3.** Select the desired **Expression** from the drop-down menu. If any other parameter is necessary to set, it is going to be displayed.
- Step 4.** Press the **Apply** button to store the settings of the Condition.

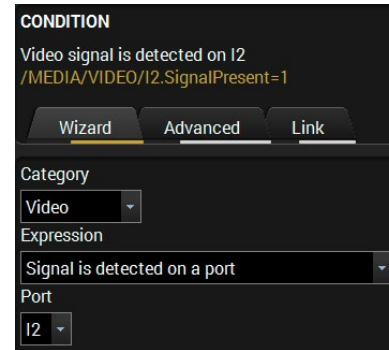

Advanced Mode

The goal of this mode is the same as of the wizard: set the properties and methods for conditions and actions. The difference is the number of the available and usable properties and methods of the LW3 protocol. Advanced mode allows almost all of it.

- Step 1.** Click on the **Edit** button of the desired Event; the **Event editor** is displayed.
- Step 2.** The wizard mode is the default, press the **Advanced** button. The LW3 protocol tree is displayed showing the list of the properties in the drop-down menu. Navigate to the desired node.
- Step 3.** Select the desired **Property** from the menu. The **manual** of the property is displayed below to help to select the necessary property and to set the value.
- Step 4.** Set the desired **value** and **operator**, then press the **Apply** button to store settings.

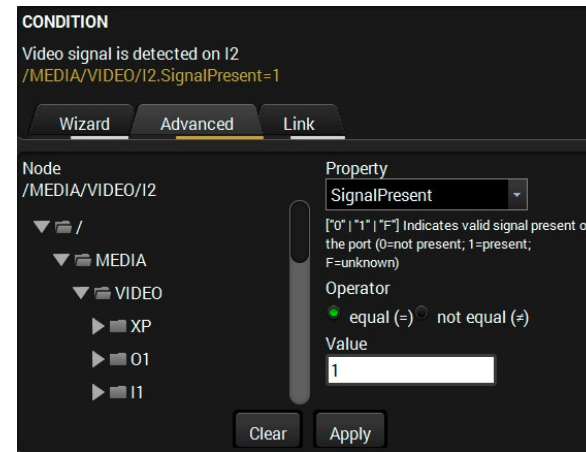

The Link Tool

The new interface allows creating more actions for the same condition. In that case, a condition can trigger more actions. To set such an Event, the Link tool has been introduced.

- Step 1.** Click on the **Edit** button of the desired Event; the **Event editor** is displayed.
- Step 2.** The wizard mode is displayed as default, press the **Link** button.
- Step 3.** All the saved Events are analyzed and the **conditions** are listed (it takes some seconds to finish). The **Show advanced expressions** option allows showing the exact path and set the value of the given property.
- Step 4.** Select the desired **Condition** and press the **Apply** button to store the settings.

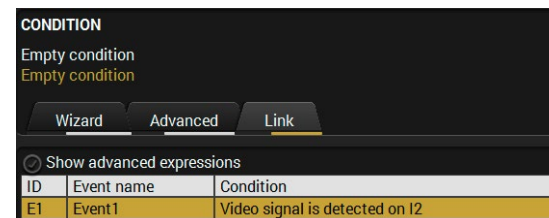

5.10.3. Special Tools and Accessories

The Name of the Event

The name of a port can be changed by typing the new name and clicking the **Set** button. The following characters are allowed when naming: Letters (A-Z) and (a-z), numbers (0-9), special characters: hyphen (-), underscore (_), and space ().

Enable or Disable an Event

The set Event can be enabled or disabled in the Event list, or directly in the Event editor window by setting the **tick mark** beside the name.

Testing the Condition

When the desired Condition is arranged, the setting can be tested. The Event list and the Event editor contains a small panel that shows if the set condition is detected and how many times. The **Counter** can be reset by the button in Event editor. If the Condition is true, the **detected** mark turns green for two seconds and the **Counter** is increased.

Testing the Action

The method is the same as testing the Condition, but in this case, the Action can be triggered manually by pressing the **Test** button.

TIPS AND TRICKS: The Test button is also placed on the Action panel in the Event list. Thus, you can check the Actions without opening the Event editor.

Delay the Action

In most cases the Action is performed immediately after the Condition is detected. But sometimes a delay is necessary between the Condition and the Action. Therefore, the new Event manager contains the Delay panel which allows that feature with below settings:

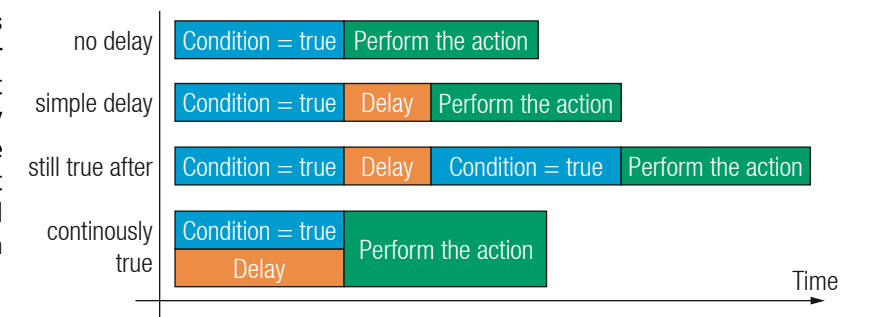

- **No delay:** when the Condition is detected, the Action is launched.
- **Simple delay:** when the Condition is detected, the Action is launched after the set time interval.
- **Still true after:** when the Condition is detected, the Action is launched after the set time interval only if the Condition still exists.
- **Continuously true:** when the Condition is detected, the Action is launched after the set time interval only if the Condition has been existing continuously.

TIPS AND TRICKS: **Show advanced expressions** option is a useful tool when you look for the path or value of a property but just the expression is displayed. The option is available in the Event list window or when Link tool is used.

5.10.4. Clear One or More Event(s)

Clear an Event

Press the **Clear** button in the Event list or in the header section in the Event editor.

Clear all Events

When all the Events must be cleared press the **Load factory defaults** button above the Event list. You will be prompted to confirm the process.

ATTENTION! Clicking on Load factory defaults button means, the configuration of the buttons are also deleted, because the conditions and the actions of the buttons are saved as events.

5.10.5. Export and Import Events

The feature allows saving all the Events. The backup file can be uploaded to another MMX4x2 series matrix.

Export all the Events

Step 1. Press the **Export** button above the Event list.

Step 2. The Save as dialog box will appear. Set the desired folder and file name, then press the **Save** button.

The generated file is a simple text file which contains LW3 protocol commands. The file can be viewed by a simple text editor, e.g. Notepad.

ATTENTION! Editing the file is recommended only for expert users.

Import all the Events

Step 1. Press the **Import** button above the Event list.

Step 2. The Open dialog box will appear. Select the desired folder and file, then press the **Open** button.

5.10.6. Event Creating - Example

The following example shows you on a real-life situation how to set up an Event.

The Concept

The MMX4x2-HDMI matrix is connected to a projector by the HDMI out 1 port. The matrix is also connected to the projector by the RS-232 port and can send commands via the serial line. The task is to turn on the projector when signal is detected on the HDMI out 1 port.

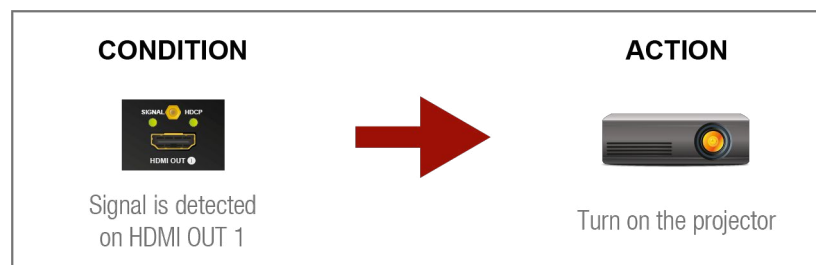

RS-232 Settings

Make sure that the serial line is established between the matrix and the projector. Check that the RS-232 settings of the matrix is set exactly the same which required for the projector: baud rate, data bits, parity, stop bits. The matrix needs to be set to: Control protocol: LW3; and RS-232 mode: Control. See the relevant LDC settings in the [RS-232](#) section.

Setting the Event

You can create the Event in the Wizard in few simple steps:

Step 1. Set the condition.

Select the required parameters to set the condition:

- **Category:** Video;
- **Expression:** Signal is detected on a port;
- **Port:** 01.

Click on the **Apply** button to complete the procedure. When it is done, the condition appears on the upper side in textual and LW3 command format as well.

Step 2. Set the action.

If the condition is fulfilled, the following action needs to be launched: the receiver sends a command to the projector over the serial line:

- **Power on** - the required command which is accepted by the projector: PWR0<CR><LF>

For this instance the command has to be closed with the <CR><LF> characters so they need to be escaped. You can use the following format for escaping:

<command₁><\x0d\x0a><command₂><\x0d\x0a>...
...<command_n><\x0d\x0a>

In the current case the command is: PWR0\x0d\x0a

Select the required parameters to set the action:

- **Category:** RS-232;
- **Expression:** Send RS-232 message;
- **Port:** P1;
- **Message:** PWR0\x0d\x0a

Step 3. Enable the Event.

Select the **E1 enabled** pipe in upper left corner to set the Event as launched.

INFO: If you do not find the required category/expression/etc what you need, choose the Advanced mode in the Wizard where the entire LW3 structure tree is available. For example instead of signal detection you can set a specified resolution or color range either as a condition.

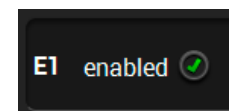
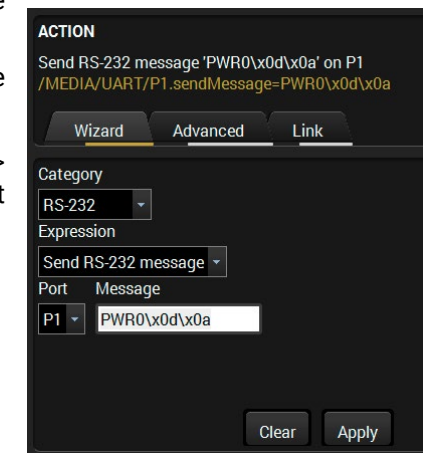

5.11. Settings Menu

5.11.1. Status

General

Product name	MMX4x2-HDMI
MAC address	a8:d2:36:ff:44:29
Hardware version	V11_AAA0
Device label	MMX4x2-HDMI <input type="button" value="Set"/>
Part number	91310034
Serial number	00004429
Button lock	<input type="radio"/>

Built-in miniweb

Open miniweb

Upload built-in miniweb

Actual file size 0 bytes

Max file size limit 1048576 bytes

Clear built-in miniweb

Identify device

Identify me

Operation

System uptime	5 days 01h 08m 42s
Operation time	5 days 01h 08m 32s
High temp operation time	0 days 00h 00m 00s

Firmware versions

CPU firmware version	1.5.0b5 r82
Package version	1.5.0b7 r47

Temperatures

CPU temperature	34 °C (33 °C min, 36 °C max)
System temperature	34 °C (33 °C min, 36 °C max)

Voltages

12 V local	12.15 V (12.12 V min, 12.18 V max)
5 V main	5.02 V (5 V min, 5.04 V max)
3.3 V main	3.35 V (3.34 V min, 3.36 V max)
3.3 V audio DAC	3.29 V (3.28 V min, 3.3 V max)
1.3 V main	1.31 V (1.3 V min, 1.31 V max)

Advanced view

Status tab in Settings menu

The most important hardware and software related information can be found on this tab: hardware and firmware version, serial numbers, temperatures, operation time, and voltage information. Device label can be changed to unique description by the **Set** button. [#buttonlock](#) [#lockbutton](#)

You can disable the functionality of the front panel buttons with marking the **Button lock** option. This is same method of the control lock made by the front panel buttons. See the details in the [Control Lock](#) section.

Please note that the Miniweb-related descriptions can be found in [The Built-in Miniweb](#) section.

Clicking on the **Identify me** button results the blinking of the status and crosspoint LEDs in green for 10 seconds. The feature helps to identify the device itself in the rack shelf.

[#devicelabel](#) [#label](#) [#producttype](#) [#firmwareversion](#) [#identifyme](#) [#status](#)
[#serialnumber](#)

5.11.2. Network

General

Current IP address	192.168.0.85
Current subnet mask	0.0.0.0
Current gateway address	192.168.0.1
Obtain IP address automatically (DHCP, AutoIP)	<input type="radio"/>
Static IP address	192.168.0.85
Static subnet mask	0.0.0.0
Static gateway address	192.168.0.1
LW2 port	10001
LW3 port	6107
HTTP port	80

Apply changes

Advanced view

Network tab in Settings menu

IP address and DHCP settings can be set on this tab. Always press the **Apply settings** button to save changes. Factory defaults settings can be recalled with a dedicated button.

5.11.3. Backup

Details about this function can be found in the [Configuration Cloning \(Backup Tab\)](#) section.

[#ipaddress](#) [#network](#) [#dhcp](#)

5.11.4. System

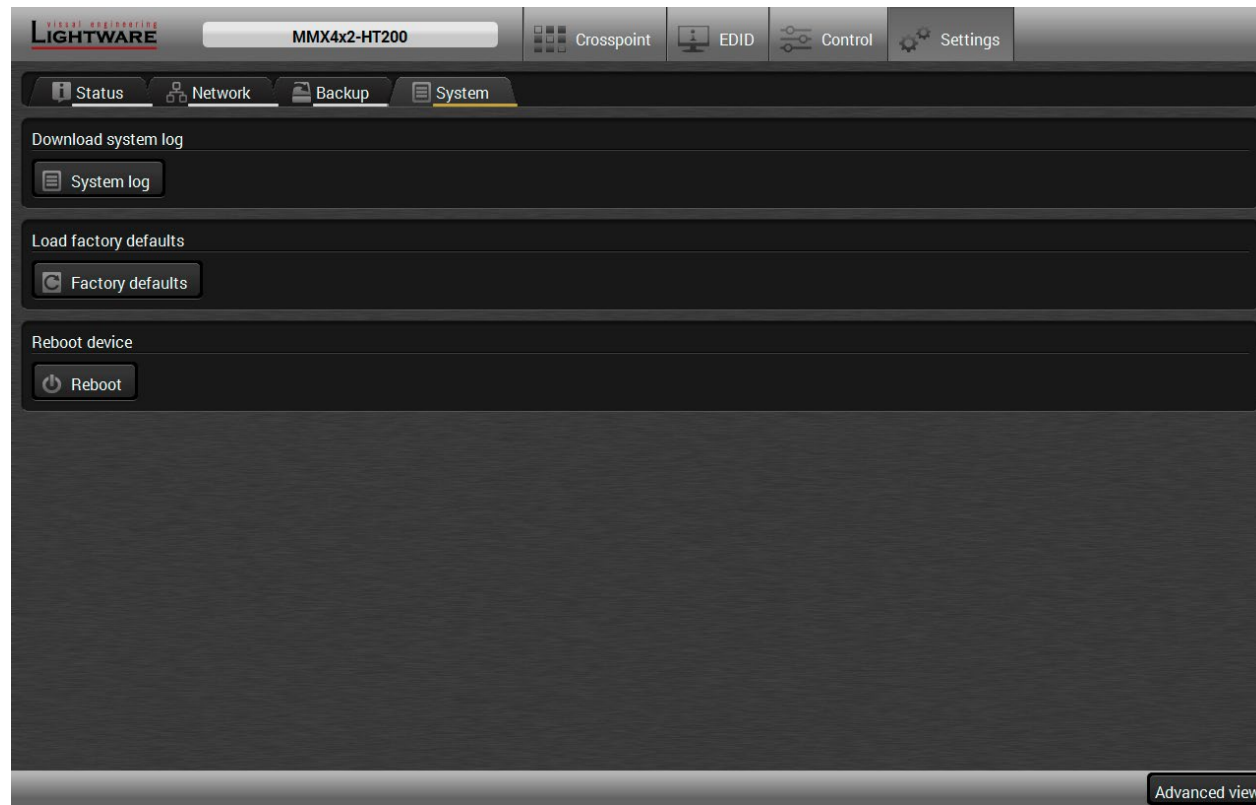

System tab in Settings menu

Three functions are available under System tab:

- **Download system log** - saving the file of the device.
- **Load factory defaults** - recalling factory defaults settings and values. All factory default settings are listed in the [Factory Default Settings](#) section.
- **Reboot** - rebooting the system.

#factory #log #systemlog #reboot #restart

5.12. The Built-in Miniweb

DEFINITION: The miniweb is a dedicated location in the memory where an HTML file can be uploaded to. If the <IP_address>/index.html page is opened in a web browser the file is displayed.

ATTENTION! The Miniweb is available from firmware package v1.2.0. The default control page can be installed in the device during the first firmware upgrade process by the user if the necessary parameter is enabled. See the [Step 3. Check the upgrade parameters.](#) section.

The default control page allows the followings: #builtinweb #miniweb #web #new

- **Source selection:** This block can be used to select an input or enable/disable the Autoselect remotely e.g. from a mobile device.
- **Action triggers:** The action trigger buttons can be used to perform a configured Event Action without waiting for the condition to occur. This can be done remotely by a mobile device, too.

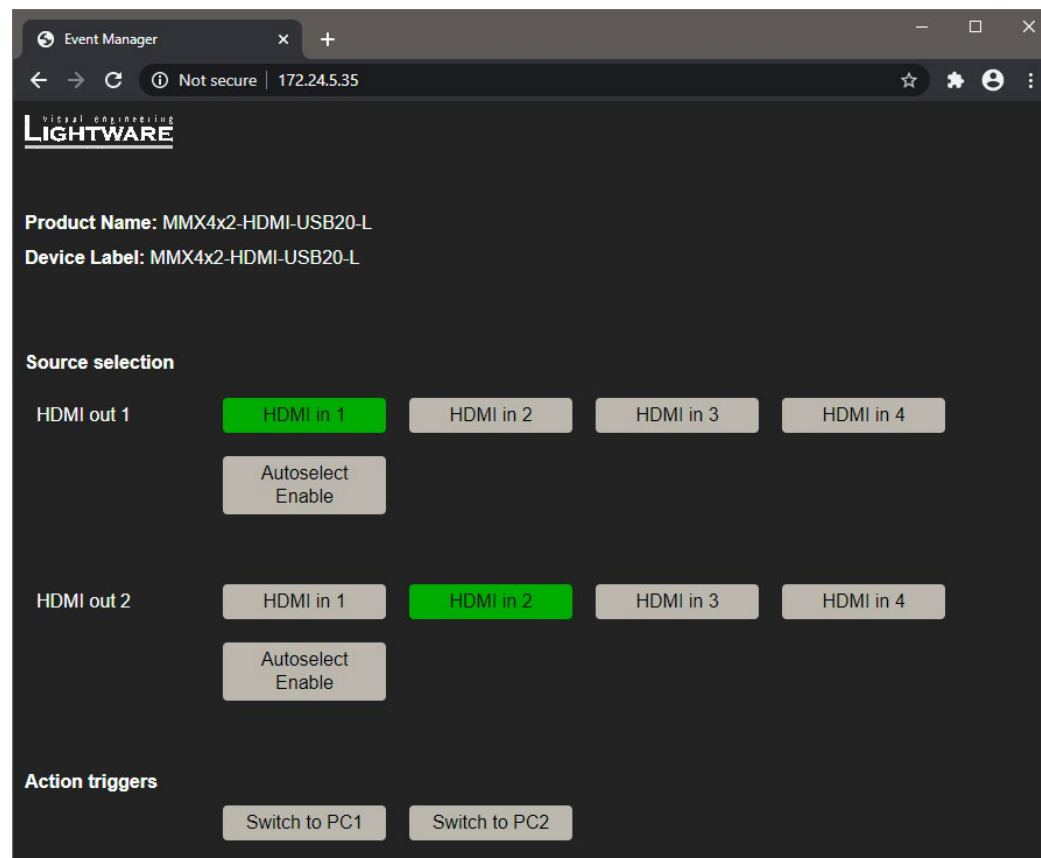

The Control Page Displayed in a Desktop Browser (with Action Trigger Buttons)

5.12.1. Opening the Miniweb

The Miniweb is available by:

- Opening the **web browser** and typing the **IP address** of the desired device in the address line,
- Launching the **LDC**, connecting to the device, navigating to **Settings/Status** and pressing the **Open miniweb** button.

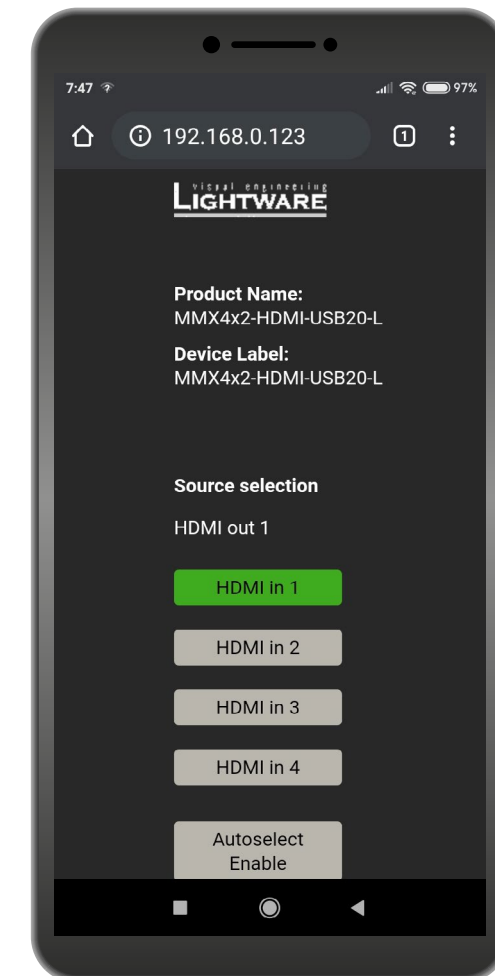

The Control Page Displayed in a Smartphone Browser

5.12.2. The Default Status Page

If there is no control page uploaded, the default status page will be displayed (which is also available by opening the <IP_address>/status.html address).

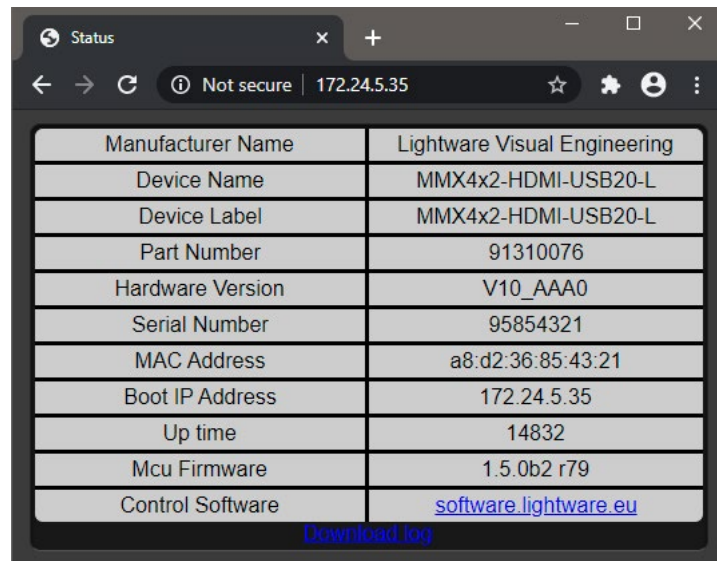

The Factory Default Status Page (status.html)

5.12.3. Miniweb Customization

The buttons of **Action triggers** section are linked to Actions of certain Events in the Event Manager. These buttons are displayed **only** for specific events:

- Any Event which does **not** have the @W suffix in its name will **not** be displayed as a trigger button.
- The displayed trigger buttons will get a **text label** with the **event name** except the suffix.

To add the desired Action as a button, **append the name** of the desired Event with the @W characters - see below:

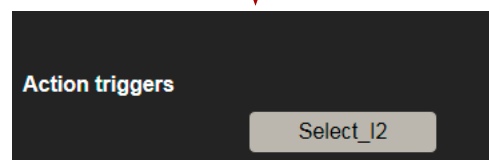
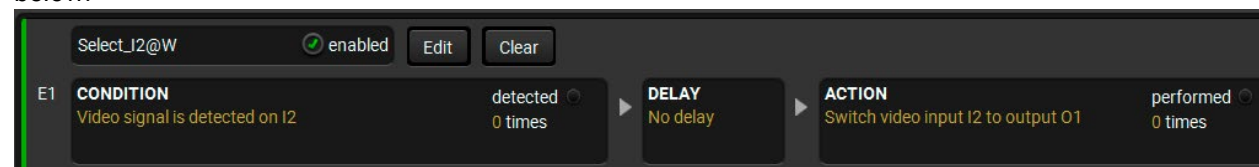

Action Trigger Button added in the Event Manager and displayed in the Control Page

Customized HTML

The default control page can be replaced in the LDC; navigate to the **Settings/Status** page. Custom HTML file can be uploaded by pressing the **Choose file** button. Pay attention to the size of the HTML file. Only one file is allowed and the maximum file size is 10 KB (in case of SW4-TPS-TX240-Plus it's 80 KB).

Press the **Reset** button to remove the control page. The default control page can be restored during a firmware upgrade process, see the [Step 3. Check the upgrade parameters.](#) section.

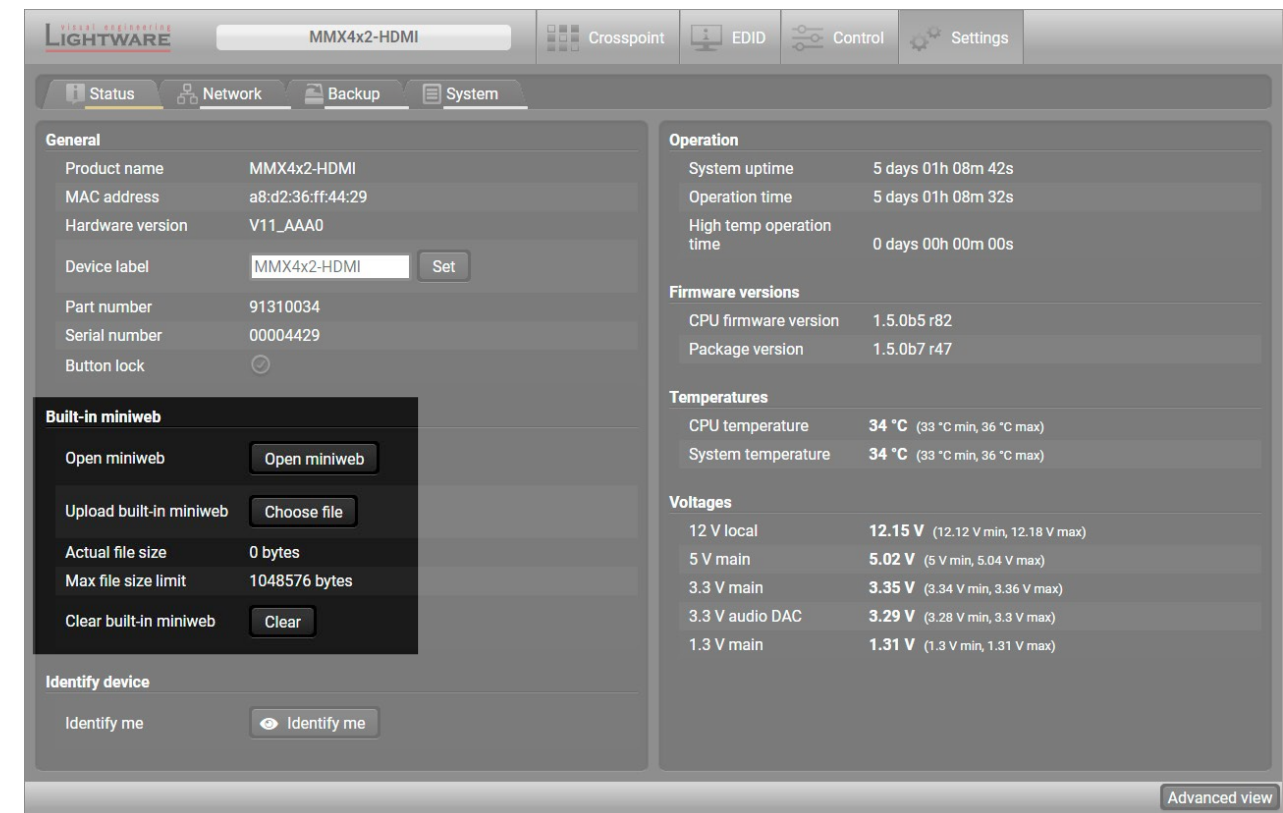

The Built-in Miniweb Section in LDC

5.13. Configuration Cloning (Backup Tab)

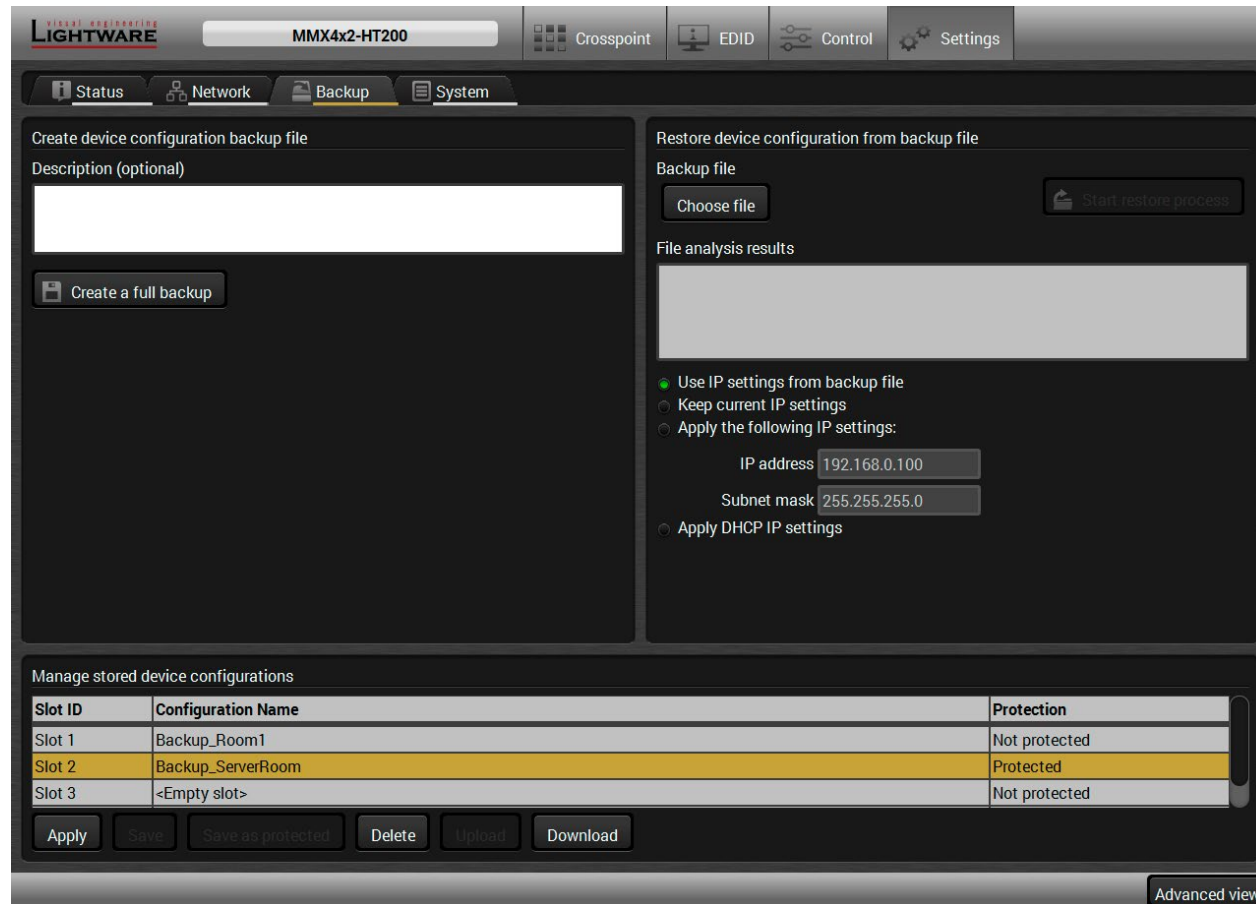

Backup tab

The configuration cloning of Lightware LW3 devices is a simple method that eliminates the need to repeatedly configure certain devices to have identical (non-factory) settings. If the devices are installed in the same type of system multiple times then it is enough to set up only one device to fit the user's needs and then copy those settings to the others, thus saving time and resources. *#backup #configurationcloning*

5.13.1. Cloning Steps in a Nutshell

Installing multiple devices with the same customized configuration settings can be done in a few easy steps:

- Step 1.** Configure one device with all your desired settings with the LDC software.
- Step 2.** Backup the full configuration file to your computer.
- Step 3.** If needed, make some modifications to the configuration file using a text editor (e.g. Notepad). E.g. modifying the static IP address is needed when DHCP is not used.
- Step 4.** Connect to the other device which has to be configured and upload (restore) your configuration file.
- Step 5.** Done! You can have as many totally identical, customized devices as you like.

5.13.2. Save the Settings of the Device (Backup)

- Step 1.** Apply the desired settings in the transmitter (port parameters, crosspoint, etc.)
- Step 2.** Select the **Settings / Backup** tab from the menu.
- Step 3.** Write a short **description** in the text box on the left (optional).
- Step 4.** Press the **Create a full backup** button. You will be prompted to save the file to the computer. The default file name is the following:

```
BACKUP_<DEVICE TYPE>_SN<SERIAL NUMBER>.LW3
```

- Step 5.** Set the desired **file name**, select the folder and **save** the file.

TIPS AND TRICKS: Using the exact product type in the filename is recommended since it makes the file usage more comfortable.

About the Backup File

The backup file is a simple text file which contains LW3 protocol commands. The first line is the description, and the further lines are the commands which will be executed during the restore process. The file can be viewed (and/or edited) by a simple text editor, e.g. Notepad.

ATTENTION! Editing the command lines is only recommended for expert users.

See the entire list of saved data in the [Mechanical Drawings](#) section.

5.13.3. Upload the Settings to a Device (Restore)

WARNING! Please note that the settings will be permanently overwritten with the restored parameters in the device. Withdrawal is not possible.

ATTENTION! The cloning is successful when the backup file is downloaded from the same type of source device as the destination device.

The Restoring Process

- Step 1.** Select the **Settings / Backup** tab from the menu.
- Step 2.** Click on the **Choose file** button on the right panel and **browse** the desired file.
- Step 3.** The file is checked and the result will be displayed in the textbox below. If the file is correct, the settings can be restored.
- Step 4.** Choose **IP settings** what you want to use after backup. You can apply settings from the backup file, keep actual settings, set it manually in a dialog box or apply DHCP.
- Step 5.** Press the **Start restore process** button and click on the **Yes** button when asked.
- Step 6.** Reboot the device to apply the network settings after finishing.

5.13.4. Create and Restore Backups from the Device Memory

MMX4x2 series matrix is able to store backups in its own memory and can be recalled from there so user does not need to save backup files to the local computer. Four slots are available for this purpose.

Slot ID	Configuration Name	Protection
Slot 1	Preset_0720	Not protected
Slot 2	backup_0125	Protected
Slot 3	<Empty slot>	Not protected
Slot 4	<Empty slot>	Not protected

Buttons: Apply, Save, Save as protected, Delete, Upload, Download

You can save presets as not protected with using **Save** button and as protected with using the **Save as protected** button. Restoring a preset select on the slot of the desired backup and click on the **Apply** button. You can save presets from a file from your local computer clicking on the **Upload** button and you can also save a preset from the device's memory to a backup file with using the **Download** button. If you do not need a saved preset any more, select it and click on the **Delete** button.

WARNING! Loading factory default settings will erase all presets which has been saved in the device memory!

5.14. Advanced View Window

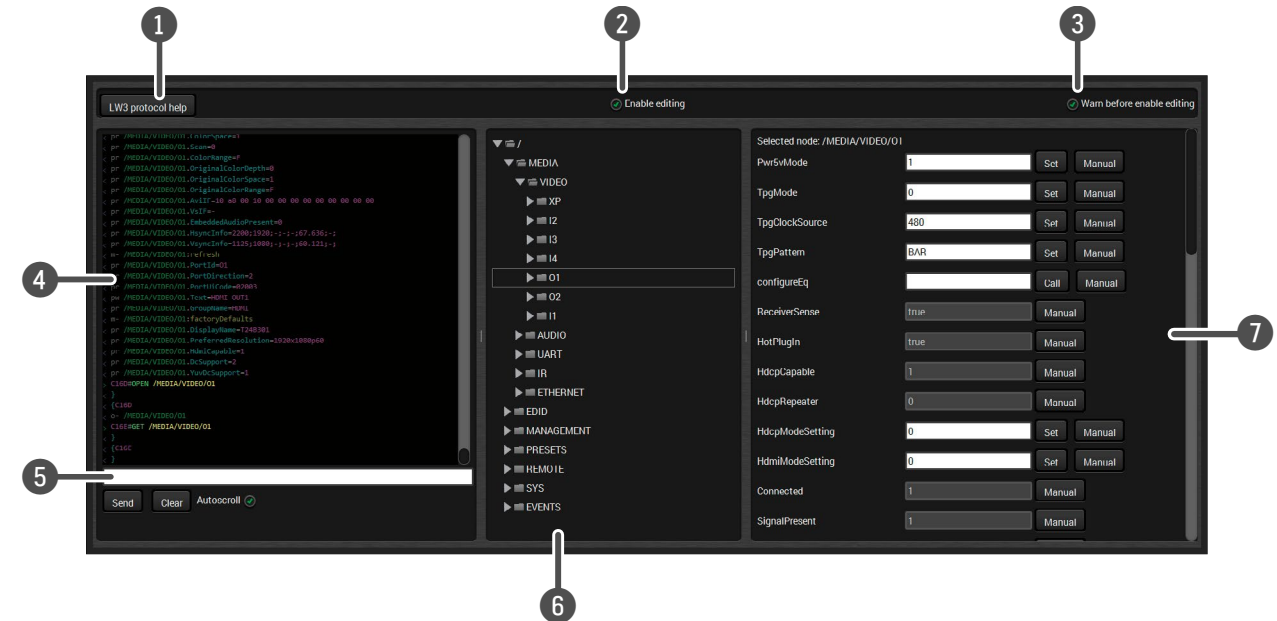

- 1 **LW3 protocol help** Pushing the button results a help window opening which describes the most important information about LW3 protocol commands in HTML format.
- 2 **Edit mode** The default appearance is the read-only mode. If you want to modify the values or parameters, tick the option. You will be prompted to confirm your selection.
- 3 **Warning mode** If this is checked, a warning window pops up when you enable Edit mode.
- 4 **Terminal window** Commands and responses with time and date are listed in this window. Sent command starts with '>' character, received response starts with '<' character. The color of each item depends on the type of the command and response. The content of the window can be emptied by the **Clear** button. If the **Autoscroll** option is ticked, the list is scrolled automatically when a new line is added.
- 5 **Command line** Type the desired command and execute it by the **Send** button. Clear all current commands and responses in the Terminal window by the **Clear** button.
- 6 **Protocol tree** LW3 protocol tree; select an item to see its content.
- 7 **Node list** Correspondent parameters and nodes are shown which are connected to the selected item in the protocol tree.
 - Manual** button: Manual (short description) of the node can be called and displayed in the terminal window.
 - Set** button: Saves the value/parameter typed in the textbox.
 - Call** button: Calls the method, e.g. reloads factory default settings.

#advancedview
#terminal

6

LW2 Programmers' Reference

The device can be controlled through a reduced command set of LW2 protocol commands to ensure the compatibility with other Lightware products. The supported LW2 commands are described in this chapter.

- ▶ [PROTOCOL DESCRIPTION](#)
- ▶ [INSTRUCTIONS FOR THE TERMINAL APPLICATION USAGE](#)
- ▶ [GENERAL LW2 COMMANDS](#)
- ▶ [A/V PORT SETTINGS](#)
- ▶ [NETWORK CONFIGURATION](#)
- ▶ [GPIO PORT CONFIGURATION](#)
- ▶ [LW2 COMMANDS – QUICK SUMMARY](#)

6.1. Protocol Description

The protocol description hereinafter stands for Lightware protocol. The commands can be sent to the device in RAW format via the TCP/IP port no. 10001.

The receiver accepts commands surrounded by curly brackets - { } - and responds data surrounded by round brackets - () - only if a command was successfully executed. All input commands are converted to uppercase, but respond commands can contain upper and lower case letters as well.

Legend for Control Commands

Format	Explanation
<in>	Input number in 1 or 2 digit ASCII format (01, 5, 07, 16, etc.)
<out>	Output number in 1 or 2 digit ASCII format
<in/out>	input or output port number in 1 or 2 digit ASCII format *
<in2>	Input number in 2 digit ASCII format (01, 02, 10, 12 etc.)
<out2>	Output number in 2 digit ASCII format (01, 02, 10, 12 etc.)
<in2/out2>	input or output number in 2 digit ASCII format*
<loc>	Location number in 1, 2 or 3 digit ASCII format
<id>	id number in 1 or 2 digit ASCII format
<id2>	id number in 2 digit ASCII format
CrLf	Carriage return, Line feed (0x0D, 0x0A)
.	Space character (0x20)
→	Each command issued by the controller
←	Each response received from the router

* The command has the same arguments on the input ports and the output port, as well.

6.2. Instructions for the Terminal Application Usage

Terminal Application

The LW2 protocol commands can be applied to the receiver using a terminal application. You need to install one of them to your control device, for example **Putty** or **CLI**. *#terminal*

Establishing Connection

Follow the steps for establishing connection to the receiver:

- Step 1.** Connect the receiver to a LAN over Ethernet.
- Step 2.** Open the terminal application (e.g. Putty).
- Step 3.** Add the **IP address** of the device (default: 192.168.0.100) and the **port number (10001)**.
- Step 4.** Select the **Raw** connection type, and open the connection.

Once the terminal window is opened, you can enter the LW2 protocol commands which are listed in the following sections.

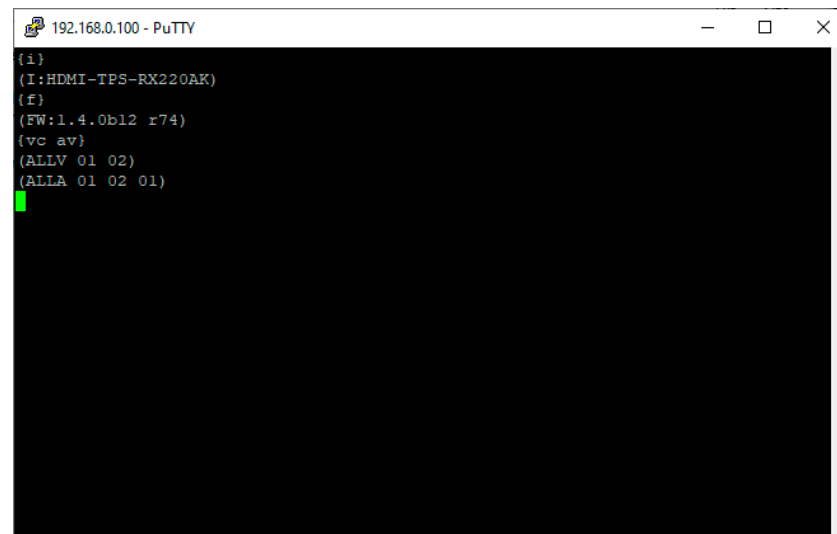
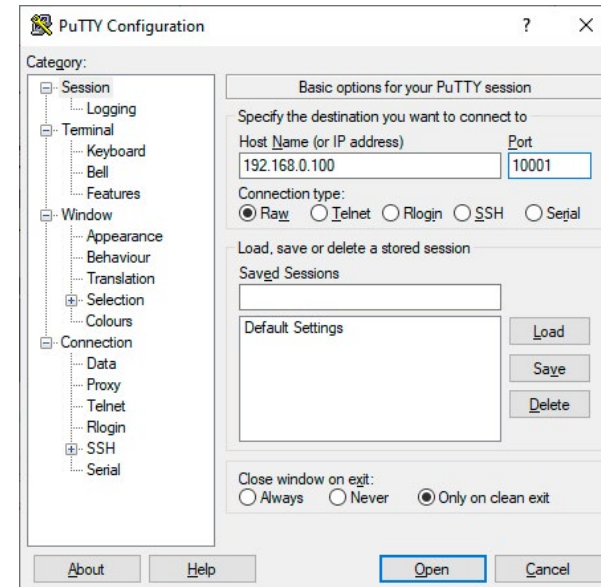

LW2 protocol command communication in a terminal window

6.3. General LW2 Commands

6.3.1. View Product Type

The device responds its name.

Command and Response *#producttype*

→ {i}
← (I:<PRODUCT_TYPE>)CrLf

Example

→ {i}
← (I:MMX4x2-HT200)

6.3.2. Query Control Protocol

The device can be controlled with different control protocols. This command queries the active protocol of the currently used control interface.

Command and Response *#protocol*

→ {P_?}
← (CURRENT·PROTOCOL:=·#<protocol>)CrLf

Example

→ {p_?}
← (CURRENT PROTOCOL = #1)

'#1' means the device communicates with LW2 protocol.

6.3.3. View Firmware Version of the CPU

View the CPU firmware version.

Command and Response *#firmwareversion*

→ {F}
← (FW:<FW_VER><s>)CrLf

Example

→ {p_?}
← (CURRENT PROTOCOL = #1)

<FW_VER> is the firmware version. It is followed by <s> string which may indicate special versions.

6.3.4. Connection Test

Simple test to see if the connection is established successfully.

Command and Response

```
→ {PING}
← (PONG!)CrLf
```

Example

```
→ {ping}
← (PONG!)
```

6.3.5. View Serial Number

The device responds its 8-digit serial number.

Command and Response *#serialnumber*

```
→ {S}
← (SN:<SERIAL_N>)CrLf
```

Example

```
→ {s}
← (SN:5A004254)
```

The serial number structure can be found in the [About the Serial Number](#) section.

6.3.6. Compile Time

Returns the date, when the CPU firmware was compiled.

Command and Response

```
→ {CT}
← (Complied: <DATE&TIME>)CrLf
```

Example

```
→ {ct}
← (Compiled: Sep 30 2016 14:07:56)
```

6.3.7. View Installed Board

Shows the hardware name and revision of the installed cards.

Command and Response

```
→ {IS}
← (SL#·0·<MB_DESC>)CrLf
← (SL-END)CrLf
```

Example

```
→ {is}
← (SL# 0 MMX4x2-HT200 V12_DAA0)
← (SL END)
```

The device reports its motherboard (slot 0).

6.3.8. View Firmware for All Controllers

Shows the firmware versions of all installed controllers.

Command and Response

```
→ {FC}
← (CF·<DESC>)CrLf
← (CF·<DESC>)CrLf
← ...
← (CF END)CrLf
```

Example

```
→ {fc}
← (CF MMX4x2-HT200 1.3.4b3)
← (CF END)
```

The device has one control panel.

6.3.9. Restart the Device

The device can be restarted without unplugging power.

Command and Response *#reboot #restart*

```
→ {RST}
←
```

Example

```
→ {rst}
←
```

The device reboots; no response is sent in this case.

6.3.10. Query Health Status

Internal voltages and measured temperature values are shown.

Command and Response *#status*

```
→ {ST}
← (ST<DESC>)CrLf
```

Example

```
→ {st}
← (ST CPU 12.16V 5.03V 3.30V 3.33V 3.37V 1.30V 1.86V 1.00V 53.22C 53.26C)
```

6.3.11. Restore Factory Default Settings

Settings can be reset to factory default values as follows:

Command and Response

```
→ {FACTORY=ALL}
← (FACTORY ALL...)CrLf
```

Example

```
→ {factory=all}
← (FACTORY ALL...).
```

All settings and parameters are reset to factory default, see the table in the [Factory Default Settings](#) section.

#factory

6.4. A/V Port Settings

6.4.1. Switch an Input to the Outputs

Switching an input <in> to output <out>. Following commands with A, V, AV parameter value can take effect in multiple layers, according to their parameters. Depending on 'A' or 'V' it can change only the Audio or only the Video layer; or 'AV' changes both. *#crosspoint* *#switch*

Command and Response

```
→ {<in>@<out>•<layer>}
← (O<out2>•I<in2>•<layer>)CrLf
```

Parameters

Parameter	Parameter description	Value	Value description
<layer>	Signal type of the layer	A	audio layer
		V	video layer
		AV	audio & video layer
<out>	Output port	01..02	
<in>	Input port	I1..I4	
		0	Using the '0' (zero) value the input will be disconnected and no signal will appear on the output.

INFO: The <layer> parameter usually can be skipped for legacy purposes. In this case, the devices change all (Video & Audio) layers but using status commands it displays information about only the Video layer. Please use AV option, when available.

Example 1

```
→ {2@1 AV}
← (001 I02 AV)
```

I2 audio and I2 video input ports are switched to O1 output port.

Example 2

```
→ {0@1}
← (001 I00)
```

ATTENTION! The response of this command does not show if the output is muted. To check the mute status a separate query has to be used like {VC}.

ATTENTION! Analog video inputs does not contain embedded audio. If you use the AV option in case of VGA input (I1) the audio will be switched to the analog audio input 1 (I1) and in case of DVI-A input (I5) the audio will be switched to the analog audio input 2 (I5).

6.4.2. Mute Output

Mute the <out> output. The output signal is turned off.

Command and Response #mute #lock #unmute #unlock

→ {#<out>•<layer>}
← (1MT<out2>•<layer>)CrLf

Example

→ {#01 A}
← (1MT01 A)

ATTENTION! Muting does not change the state of the crosspoint but disables the output itself. This way the last connection can be easily restored with an unmute command. Switching a muted output does not unmute the output.

6.4.3. Unmute Output

Unmute the <out> output.

Command and Response

→ {+<out>•<layer>}
← (0MT<out2>•<layer>)CrLf

Example

→ {+01 V}
← (0MT01 V)

INFO: Unmuting an output makes the previous connection active as the crosspoint state has not been changed by the muting command, only the output was disabled.

6.4.4. Lock Output

Locking an output port. Output's state cannot be changed until unlocking.

Command and Response

→ {#><out>•<layer>}
← (1LO<out2>•<layer>)CrLf

Example

→ {#>01 A}
← (1L001 A)

6.4.5. Unlock Output

Unlocking an output port. The connection on output can be changed.

Command and Response

→ {+<<out>•<layer>}
← (0LO<out2>•<layer>)CrLf

Example

→ {+<01 V}
← (0L001 V)

O1 video output port is unlocked.

INFO: The device issues the above response regardless of the previous state of the output (either it was locked or unlocked).

6.4.6. View Connection State on the Output

Viewing the crosspoint state of the device; showing the input port numbers connected to the outputs.

Command and Response #crosspoint #switch

→ {VC•<layer>}
← (ALL<layer>•<001>•<002>)CrLf

Parameters

001 shows the corresponding output's connection state.

Parameter	Parameter description	Value	Value description
<layer>	Signal type of the layer	A	audio layer
		V	video layer
		AV	audio & video layer

State letters

Letter	State	Example
L	Output is locked	L01
M	Output is muted	M01
U	Output is locked and muted	U01

Example

→ {VC AV}
← (ALLV 01 02)
← (ALLA 02 02 02)

I1 video input port is connected to the O1 video output port; I2 video input port is connected to the O2 video output port; I2 audio input port is connected to all the audio output ports (O1, O2, O3).

6.4.7. View Crosspoint Size

Shows the physical crosspoint size.

Command and Response

```
→ {getsize<layer>}
← (SIZE=<size>•<layer>)CrLf
```

Parameters

Parameter	Parameter description	Value	Value description
<size>	Crosspoint size	<number_of_inputs>x<number_of_outputs>	
<layer>	Signal type of the layer	A	audio layer
		V	video layer
		AV	audio & video layer

Example

```
→ {GETSIZE AV}
← (SIZE=4x2 V)
← (SIZE=3x3 A)
```

The device has a video crosspoint (4 inputs and 2 outputs) and an audio crosspoint (3 inputs and 3 outputs).

6.4.8. Change the Video Autoselect Mode

The autoselect mode of the video outputs can be changed.

Command and Response *#autoselect*

```
→ {AS_V<out>=<state>;<mode>}
← (AS_V<out>=<state>;<mode>)CrLf
```

Parameters

Parameter	Parameter description	Value	Value description
<state>	Showing the Autoselect state	E	autoselect is enabled
		D	autoselect is disabled
<mode>	The autoselect mode setting	F	First detect mode
		L	Last detect mode
		P	Priority detect mode

The output port numbers are listed in [Input/Output Port Numbering](#) section.

Example

```
→ {as_v1=E;P}
← (AS_V1=E;P)
← (AS_V2=E;P)
```

The Autoselect mode of video output1 and output 2 is enabled and set to Priority mode.

INFO: The Autoselect mode can be queried by typing the {as_v<out>=?} command.

6.4.9. Change the Audio Autoselect Mode

The autoselect mode of the audio outputs can be changed.

Command and Response

```
→ {AS_A<out>=<state>;<mode>}
← (AS_A<out>=<state>;<mode>)CrLf
```

Parameters

See the previous section.

Example

```
→ {as_a1=E;P}
← (AS_A1=E;P)
← (AS_A2=E;P)
```

The Autoselect mode of audio output1 and output 2 is enabled and set to Priority mode.

INFO: The Autoselect mode can be queried by typing the {as_v<out>=?} command.

6.4.10. Change the Video Input Priorities

The settings of video input priority can be changed as follows.

Command and Response

```
→ {PRIO_V<out>=<in1_prio>;<in2_prio>;...;<inn_prio>}
← (PRIO_V<out>=<in1_prio>;<in2_prio>;...;<inn_prio>)CrLf
```

Parameters

Parameter	Parameter description	Value	Value description
<in1_prio>	Priority number of the input	0-3	0: highest priority
<in2_prio>	ports between 0 and 3		3: lowest priority
<inn_prio>			

See more details about port numbering in the [Input/Output Port Numbering](#) section.

Example

```
→ {prio_v1=1;0;2;3}
← (PRIO_V1=1;0;2;3)
```

ATTENTION! Always set all the priority of the ports when changing, otherwise, the change will not be executed and the response will be the current setting (like querying the priority setting).

INFO: The video priorities can be queried by typing the {prio_v<out>=?} command.

6.4.11. Change the Audio Input Priorities

The settings of audio input priority can be changed as follows.

Command and Response

```
→ {PRIO_A<out>=<in1_prio>;<in2_prio>;...;<inn_prio>}
← (PRIO_A<out>=<in1_prio>;<in2_prio>;...;<inn_prio>)CrLf
```

Parameters

See the previous section.

Example

```
→ {prio_a1=1;0;2}
← (PRIO_A1=1;0;2)
```

Input 2 has the highest priority (0), Input 1 has the second highest (1). Input 3 has the lowest priority (2).

ATTENTION! Always set all the priority of the ports when changing, otherwise, the change will not be executed and the response will be the current setting (like querying the priority setting).

INFO: The audio priorities can be queried by typing the {prio_a<out>=?} command.

6.5. Network Configuration

6.5.1. Query the Current IP Status

The IP address settings can be queried as follows. *#dhcp #ipaddress #network*

Command and Response

```
→ {IP_STAT=?}
← (IP_STAT=<type>;<ip_address>;<subnet_mask>;<gateway_addr>)CrLf
```

Parameters

Parameter	Parameter description	Value	Value description
<type>	Assignment of the IP address	0	static
		1	dynamic (DHCP)
<ip_addr>	IP address	(four decimal octets separated by dots)	
<subnet_mask>	Subnet mask	(four decimal octets separated by dots)	
<gateway_addr>	Gateway address	(four decimal octets separated by dots)	

Example

```
→ {ip_stat=?}
← (IP_STAT=0;192.168.0.100;255.255.255.0;192.168.0.1)
```

The device has a static (fix) IP address: 192.168.0.100; the subnet mask is 255.255.255.0, the gateway address is 192.168.0.1.

6.5.2. Set the IP Address

IP address can be set as follows.

Command and Response

```
→ {IP_ADDRESS=<type>;<ip_address>}
← (IP_ADDRESS=<type>;<ip_address>)CrLf
```

Parameters

See the previous section.

Example

```
→ {ip_address=0;192.168.0.110}
← (IP_ADDRESS=0;192.168.0.110)
```

INFO: The IP address can be queried by typing the {ip_address=?} command. The response contains the fix IP address that is stored in the device even if DHCP is enabled; in this case, this IP address is not valid.

6.5.3. Set the Subnet Mask

Subnet mask can be set as follows.

Command and Response

```
→ {IP_NETMASK=<subnet_mask>}
← (IP_NETMASK=<subnet_mask>)CrLf
```

Parameters

See the [Query the Current IP Status](#) section.

Example

```
→ {ip_netmask=255.255.255.0}
← (IP_NETMASK=255.255.255.0)
```

INFO: The subnet mask can be queried by typing the {ip_address=?} command. The response contains the fix IP subnet mask that is stored in the device even if DHCP is enabled; in this case, this IP subnet mask is not valid.

6.5.4. Set the Gateway Address

Gateway address can be set as follows.

Command and Response

```
→ {IP_GATEWAY=<gateway_addr>}
← (IP_GATEWAY=<gateway_addr>)CrLf
```

Parameters

See the [Query the Current IP Status](#) section.

Example

```
→ {ip_gateway=192.168.0.50}
← (IP_GATEWAY=192.168.0.50)
```

INFO: The gateway address can be queried by typing the {ip_gateway=?} command. The response contains the static IP gateway address that is stored in the device even if DHCP is enabled. In that case, the latest valid gateway address (for static IP) is stored.

6.5.5. Apply Network Settings

Apply the network settings and restart the network interface.

Command and Response

```
→ {ip_apply}
← (IP_APPLY)CrLf
```

Example

```
→ {ip_apply}
← (IP_APPLY)
```

6.6. GPIO Port Configuration

DIFFERENCE: This section refers to the MMX4x2-HDMI-USB20-L model only. *#new*

6.6.1. Setting the Level and Direction for Each Pins

GPIO pins can be configured as follows. See more details about GPIO connector in the [GPIO - General Purpose Input/Output Ports](#) section and about the interface in the [GPIO Interface](#) section.

Command and Response *#gpio*

```
→ {GPIO<pin_nr>=<dir>;<level>}
← (GPIO<pin_nr>=<dir>;<level>)CrLf
```

Parameters

Parameter	Parameter description	Value	Value description
<pin_nr>	GPIO pin number	0-6	static
<dir>	The direction of the communication	I O	Input Output
<level>	The level of the pin	L H T	Low High Toggle between low and high

Example

```
→ {gpio1=O;H}
← (GPIO1=O;H)
```

GPIO pin 1 is set to output with high level.

INFO: The current GPIO pin configuration can be queried by typing the {GPIO<pin_nr>=?} command.

6.7. LW2 Commands – Quick Summary

General LW2 Commands

View Product Type

→ {i}

Query Control Protocol

→ {P_?}

View Firmware Version of the CPU

→ {F}

Connection Test

→ {PING}

View Serial Number

→ {S}

Compile Time

→ {CT}

View Installed Board

→ {IS}

View Firmware for All Controllers

→ {FC}

Restart the Device

→ {RST}

Query Health Status

→ {ST}

Restore Factory Default Settings

→ {FACTORY=ALL}

A/V Port Settings

Switch an Input to the Outputs

→ {<in>@<out>•<layer>}

Mute Output

→ {#<out>•<layer>}

Unmute Output

→ {+<out>•<layer>}

Lock Output

→ {#><out>•<layer>}

Unlock Output

→ {+<<out>•<layer>}

View Connection State on the Output

→ {VC•<layer>}

View Crosspoint Size

→ {getsize•<layer>}

Change the Video Autoselect Mode

→ {AS_V<out>=<state>;<mode>}

Change the Audio Autoselect Mode

→ {AS_A<out>=<state>;<mode>}

Change the Video Input Priorities

→ {PRIO_V<out>=<in1_prio>;<in2_prio>;...;<inn_prio>}

Change the Audio Input Priorities

→ {PRIO_A<out>=<in1_prio>;<in2_prio>;...;<inn_prio>}

Network Configuration

Query the Current IP Status

→ {IP_STAT=?}

Set the IP Address

→ {IP_ADDRESS=<type>;<ip_address>}

Set the Subnet Mask

→ {IP_NETMASK=<subnet_mask>}

Set the Gateway Address

→ {IP_GATEWAY=<gateway_addr>}

Apply Network Settings

→ {ip_apply}

GPIO Port Configuration

Setting the Level and Direction for Each Pins

→ {GPIO<pin_nr>=<dir>;<level>}

7

LW3 Programmers' Reference

The device can be controlled through Lightware 3 (LW3) protocol commands to ensure the compatibility with other Lightware products. The supported LW3 commands are described in this chapter.

- ▶ [OVERVIEW](#)
- ▶ [INSTRUCTIONS FOR THE TERMINAL APPLICATION USAGE](#)
- ▶ [PROTOCOL RULES](#)
- ▶ [SYSTEM COMMANDS](#)
- ▶ [VIDEO PORT SETTINGS](#)
- ▶ [AUDIO PORT SETTINGS FRM FIRMWARE V1.2.0](#)
- ▶ [AUDIO PORT SETTINGS FOR FIRMWARE V1.1.0](#)
- ▶ [ETHERNET PORT CONFIGURATION](#)
- ▶ [ETHERNET MESSAGE SENDING](#)
- ▶ [RS-232 PORT CONFIGURATION](#)
- ▶ [RS-232 MESSAGE SENDING](#)
- ▶ [RS-232 MESSAGE RECOGNIZER](#)
- ▶ [CEC COMMAND SENDING](#)
- ▶ [INFRARED PORT CONFIGURATION](#)
- ▶ [INFRARED MESSAGE SENDING](#)
- ▶ [GPIO PORT CONFIGURATION](#)
- ▶ [USB 2.0 SWITCH CONFIGURATION](#)
- ▶ [EDID MANAGEMENT](#)
- ▶ [LW3 COMMANDS - QUICK SUMMARY](#)

7.1. Overview

The Lightware Protocol #3 (LW3) is implemented in almost all new Lightware devices (matrix switchers, signal extenders and distribution amplifiers) since 2012. The protocol is ASCII-based and all commands are terminated with a carriage return (Cr, '\r') and line feed (Lf, '\n') pair. It is organized as a tree structure that provides outstanding flexibility and user-friendly handling with 'nodes', 'properties' and 'methods'. The **Advanced View** of the Lightware Device Controller software is the perfect tool for browsing and learning how the LW3 protocol can be used in practice.

7.2. Instructions for the Terminal Application Usage

Terminal Application

The LW2 protocol commands can be applied to the receiver using a terminal application. You need to install one of them to your control device, for example **Putty** or **CLI**. `#terminal`

Establishing Connection

Follow the steps for establishing connection to the receiver:

- Step 1.** Connect the receiver to a LAN over Ethernet.
- Step 2.** Open the terminal application (e.g. Putty).
- Step 3.** Add the **IP address** of the device (default: 192.168.0.100) and the **port number (6107)**.
- Step 4.** Select the **Raw** connection type, and open the connection.

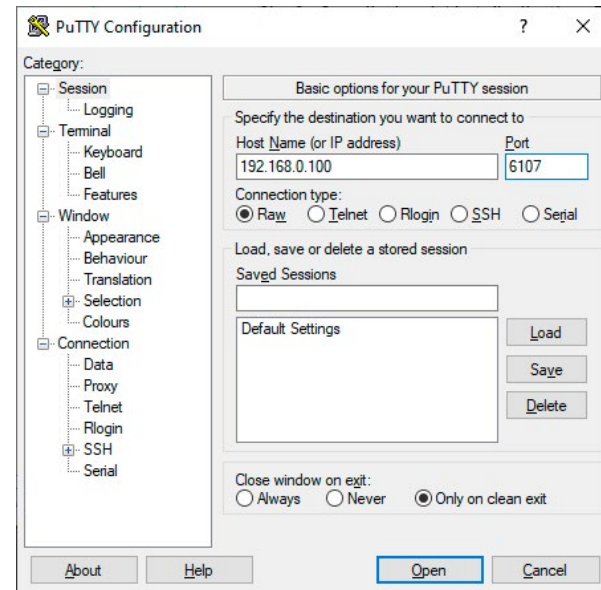

Once the terminal window is opened, you can enter the LW3 protocol commands which are listed in the following sections.

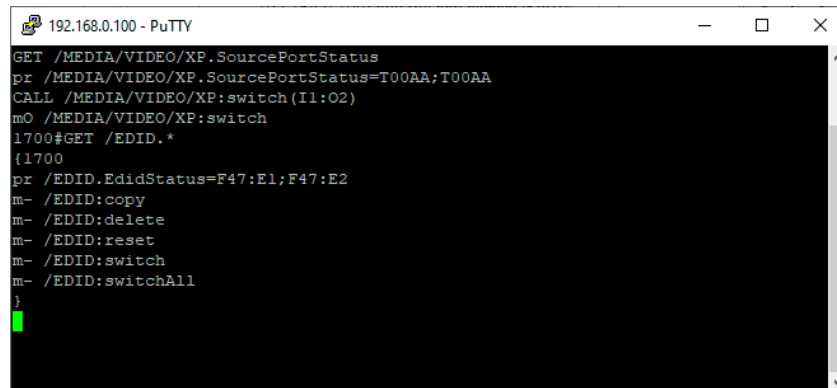

LW3 protocol command communication in a terminal window

7.3. Protocol Rules

7.3.1. LW3 Tree Structure and Command Structure (examples)

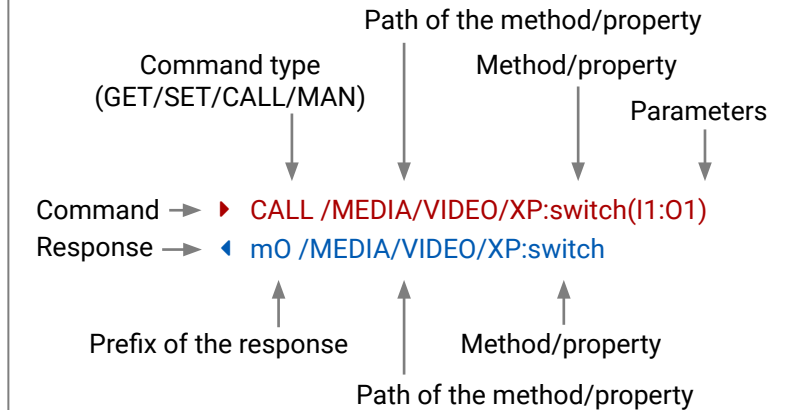
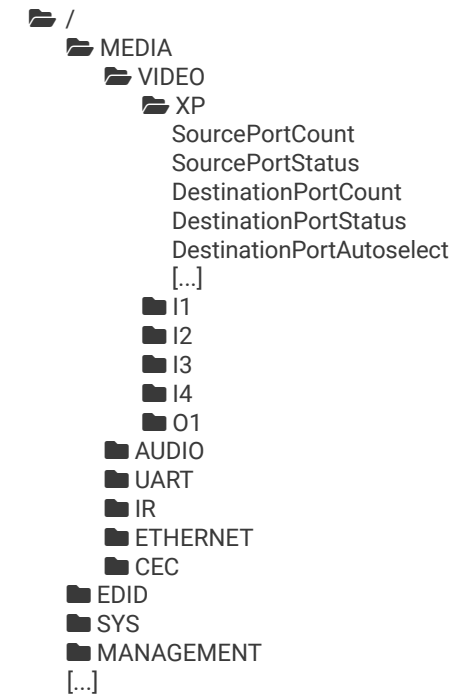

7.3.2. General Rules

- All names and parameters are **case-sensitive**.
- The nodes are separated by a slash ('/') character.
- The node name can contain the elements of the English alphabet and numbers.
- Use the **TCP port no. 6107** when using LW3 protocol over Ethernet.
- When a command is issued by the device, the received response cannot be processed by the CPU.
- The node paths describe the exact location of the node, listing each parent node up to the root.

7.3.3. Legend for the Control Commands

Command and Response – Example

- ▶ GET /MEDIA/VIDEO/I2.SignalPresent
- ◀ pr /MEDIA/VIDEO/I2.SignalPresent=<signal_present>

Format	Description
<in>	Input port number
<out>	Output port number
<port>	Input or output port number
<loc>	Location number
<parameter>	Variable defined and described in the command
<u><expression></u>	Batched parameters: the underline means that more expressions or parameters can be placed by using a semicolon, e.g. I2;I4;I5 or F27:E1;F47:E2
▶	Sent command
◀	Received response
.	Space character

Further not listed <parameters> are defined at each commands.

7.3.4. Command Types

GET command

The **GET** command can be used to get the child nodes, properties and methods of a specific node. It can also be used to get the value of a property. Use the dot character (.) when addressing a property:

- ▶ GET /.SerialNumber
- ◀ pr /.SerialNumber=87654321

GETALL command

The **GETALL** command can be used to get all child nodes, properties and methods of a node with one command.

- ▶ GETALL /MEDIA/UART
- ◀ ns /MEDIA/UART/P1
- ◀ ns /MEDIA/UART/P2
- ◀ pr /MEDIA/UART.PortCount=2
- ◀ pr /MEDIA/UART.PortUi=P1:12209;P2:12224
- ◀ pr /MEDIA/UART.P1=Local RS-232
- ◀ pr /MEDIA/UART.P2=TPS out RS-232

SET command

The **SET** command can be used to modify the value of a property. Use the dot character (.) when addressing the property:

- ▶ SET /MEDIA/VIDEO/I1.ColorSpaceMode=0
- ◀ pw /MEDIA/VIDEO/I1.ColorSpaceMode=0

CALL command

A method can be invoked by the **CALL** command. Use the colon character (:) when addressing the method:

- ▶ CALL /MEDIA/VIDEO/XP:switch(I1:O1)
- ◀ m0 /MEDIA/VIDEO/XP:switch

MAN command

The manual is a human readable text that describes the syntax and provides a hint for how to use the primitives. For every node, property and method in the tree there is a manual, type the **MAN** command to get the manual:

- ▶ MAN /MEDIA/VIDEO/O1.Pwr5vMode
- ◀ pm /MEDIA/VIDEO/O1.Pwr5vMode ["0" | "1" | "2"] 0 - Auto, 1 - Always On, 2 - Always Off

7.3.5. Prefix Summary

DEFINITION: The prefix is a 2-character long code that describes the type of the response.

The following prefixes are defined in the LW3 protocol:

Prefix	Description	Prefix	Description
n-	a node	pm	a manual for the property
nE	an error for a node	m-	a method
nm	a manual for a node	mO	a response after a success method execution
pr	a read-only property	mF	a response after a failed method execution
pw	read-write property	mE	an error for a method
pE	an error for the property	mm	a manual for a method

7.3.6. Error Messages

There are several error messages defined in the LW3 protocol, all of them have a unique error number.

- ▶ CALL /MEDIA/VIDEO/XP:switch(IA:O1)
- ◀ mE /MEDIA/VIDEO/XP:switch %E004:Invalid value

7.3.7. Escaping

DEFINITION: An escape sequence is a sequence of characters that does not represent itself when used inside a character or string literal, but is translated into another character or a sequence of characters.

Property values and method parameters can contain characters which are used as control characters in the protocol. They must be escaped. The escape character is the backslash ("\") and escaping means injecting a backslash before the character that should be escaped (like in C language).

Control characters are the following: \ { } # % () \r \n \t

The **original** message: `CALL /MEDIA/UART/P1:sendMessage(Set(01))`

The **escaped** message: `CALL /MEDIA/UART/P1:sendMessage(Set\01\)`

7.3.8. Signature

DEFINITION: The signature is a four-digit-long hexadecimal value that can be optionally placed before every command to keep a command and the corresponding responses together as a group.

Each line is terminated with a carriage return (Cr, '\r') and line feed (Lf, '\n') characters. In several cases the number of the lines in the response cannot be determined in advance, e.g. the client intends to receive for the whole response and also wants to be sure, that the received lines belong together and to the same command. In these cases, a special feature the 'signature' can be used. The response to that particular command will also be preceded by the signature, and the corresponding lines will be between brackets:

```
▶ 1700#GET /EDID.*
◀ {1700
◀ pr /EDID.EdidStatus=F89:E1;D1:E2;D1:E3;D1:E4;F89:E5
◀ m- /EDID:copy
◀ m- /EDID:delete
◀ m- /EDID:reset
◀ m- /EDID:switch
◀ m- /EDID:switchAll
◀ }
```

INFO: The lines of the signature are also Cr and Lf terminated.

7.3.9. Subscription

DEFINITION: Subscription to a node means that the user will get a notification if a property of the node changes.

A user can subscribe to any node. These notifications are asynchronous messages and are useful to keep the client application up to date, without having to periodically poll the node to detect a changed property. When the user does not want to be informed about the changes anymore, he can simply unsubscribe from the node.

ATTENTION! The subscriptions are handled separately for connections. Hence, if the connection is terminated all registered subscriptions are deleted. After reopening a connection all subscribe commands have to be sent in order to get the notifications of the changes on that connection.

Subscribe to a Node

- ▶ OPEN /MEDIA/VIDEO
- ◀ o- /MEDIA/VIDEO

Subscribe to Multiple Nodes

- ▶ OPEN /MEDIA/VIDEO/*
- ◀ o- /MEDIA/VIDEO/*

Get the Active Subscriptions

- ▶ OPEN
- ◀ o- /MEDIA/VIDEO
- ◀ o- /EDID
- ◀ o- /DISCOVERY

Unsubscribe from a Node

- ▶ CLOSE /MEDIA/VIDEO
- ◀ c- /MEDIA/VIDEO

Unsubscribe from Multiple Nodes

- ▶ CLOSE /MEDIA/VIDEO/*
- ◀ c- /MEDIA/VIDEO/*

7.3.10. Notifications about the Changes of the Properties

When the value of a property is changed and the user is subscribed to the node, which the property belongs to, an asynchronous notification is generated. This notification is called as the 'change message'. The format of such a message is very similar to the response for the **GET** command:

```
◀ CHG /EDID.EdidStatus=F48:E1
```

A Short Example of How to Use the Subscription

There are two independent users controlling the device through two independent connections (**Connection #1** and **Connection #2**). The events in the rows occur after each other.

```
▶ OPEN /MEDIA/VIDEO/QUALITY
◀ o- /MEDIA/VIDEO/QUALITY
▶ GET /MEDIA/VIDEO/Quality.QualityMode
◀ pm /MEDIA/VIDEO/QUALITY.QualityMode=graphic
▶ GET /MEDIA/VIDEO/Quality.QualityMode
◀ pm /MEDIA/VIDEO/QUALITY.QualityMode=graphic
▶ SET /MEDIA/VIDEO/Quality.QualityMode=video
◀ pw /MEDIA/VIDEO/QUALITY.QualityMode=video
◀ CHG /MEDIA/VIDEO/QUALITY.QualityMode=video → Connection #1
```

} Connection #1
} Connection #2

Explanation: The first user (**Connection #1**) set a subscription to a node. Later the other user (**Connection #2**) made a change, and thanks for the subscription, the first user got a notification about the change.

7.4. System Commands

7.4.1. Setting the Device Label

INFO: The device label can be changed to a custom text in the [Status](#) tab of the LDC software.

Command and Response *#devicelabel #label*

- ▶ SET·/MANAGEMENT/UID/DeviceLabel=<custom_name>
- ◀ pw·/MANAGEMENT/UID/DeviceLabel=<custom_name>

The Device Label can be 39 character length and ASCII characters are allowed. Longer names are truncated.

Example

- ▶ SET /MANAGEMENT/UID.DeviceLabel=4x2_Conference1
- ◀ pw /MANAGEMENT/UID.DeviceLabel=4x2_Conference1

7.4.2. Resetting the Device

The receiver can be restarted – the current connections (LAN, RS-232, USB) will be terminated.

Command and Response *#reboot #restart*

- ▶ CALL·/SYS:reset()
- ◀ mO·/SYS:reset=

Example

- ▶ CALL /SYS:reset()
- ◀ mO /SYS:reset=

7.4.3. Restore the Factory Default Settings

Command and Response

- ▶ CALL·/SYS:factoryDefaults()
- ◀ mO·/SYS:factoryDefaults=

Example

- ▶ CALL /SYS:factoryDefaults()
- ◀ mO /SYS:factoryDefaults=

The device is restarted, current connections are terminated, and the default settings are restored. See the complete list in the [Factory Default Settings](#) section.

#factory

7.4.4. Querying the Firmware Version

Command and Response *#firmwareversion*

- ▶ GET·/SYS/MB.FirmwareVersion
- ◀ pr·/SYS/MB.FirmwareVersion=<firmware_version>

Example

- ▶ GET /SYS/MB.FirmwareVersion
- ◀ pr /SYS/MB.FirmwareVersion=1.2.0b3

7.4.5. Control Lock

Enable/disable the operation of the front panel buttons.

Command and Response *#lockbutton #buttonlock*

- ▶ SET·/MANAGEMENT/UI.ControlLock=<lock_status>
- ◀ pw·/MANAGEMENT/UI.ControlLock= <lock_status>

Parameters

Parameter	Parameter description	Values	Value description
<lock_status>	Front panel button locking status	0	None: all functions of the front panel button are enabled.
		1	The front panel buttons are locked but can be unlocked by button combination. See the details in the Control Lock section
		2	The front panel buttons are locked and cannot be unlocked by button combination, only in LDC (on the Status tab) or using the LW3 command.

Example

- ▶ SET /MANAGEMENT/UI.ControlLock=1
- ◀ pw /MANAGEMENT/UI.ControlLock=1

7.4.6. Identify the Device

Calling the method results the blinking of the status LEDs for 10 seconds. The feature helps to identify the device itself in the rack shelf.

Command and Response *#identifyme*

- ▶ CALL·/MANAGEMENT/UI:identifyMe()
- ◀ mO·/MANAGEMENT/UI:identifyMe

Example

- ▶ CALL /MANAGEMENT/UI:identifyMe()
- ◀ mO /MANAGEMENT/UI/identifyMe

7.5. Video Port Settings

INFO: Video port numbering can be found in the [Input/Output Port Numbering](#) section.

7.5.1. Querying the Status of the Input Ports

Command and Response `#crosspoint #hdcp #portstatus #switch #portstatus`

- ▶ GET-/MEDIA/VIDEO/XP.SourcePortStatus
- ◀ pr-/MEDIA/VIDEO/XP.SourcePortStatus=<in1_state>;<in2_state>;<in3_state>; <in4_state>

The response contains 5 ASCII characters for each port. The first character indicates the mute/lock state, the next four characters represent a 2-byte HEX code showing the current state of the input ports.

Example `#mute #lock #unmute #unlock`

- ▶ GET /MEDIA/VIDEO/XP.SourcePortStatus
- ▶ pr /MEDIA/VIDEO/XP.SourcePortStatus=T00AA;T00EF;T00AA;T00AA

Parameters

Letter (Character 1)		
	Mute state	Lock state
T	Unmuted	Unlocked
L	Unmuted	Locked
M	Muted	Unlocked
U	Muted	Locked

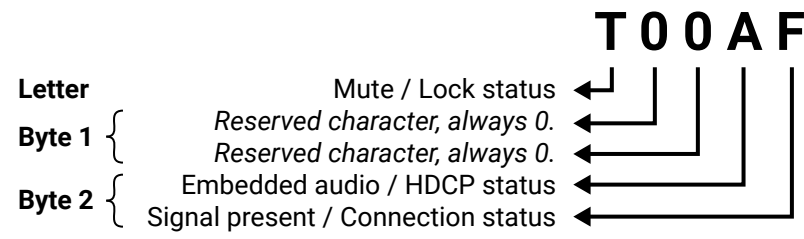

	Byte 1				Byte 2			
	Character 2		Character 3		Character 4		Character 5	
	BIT 7-6	BIT 5-4	BIT 3-2	BIT 1-0	BIT 7-6	BIT 5-4	BIT 3-2	BIT 1-0
	Reserved	Reserved	Reserved	Reserved	Embedded audio status	HDCP status	Signal present status	Connection status
00					Unknown			
01					Reserved			
10	Reserved	Reserved	Reserved	Reserved	No embedded audio	Not encrypted	No signal	Not connected
11					Embedded audio presents	Encrypted	Signal presents	Connected

Example and Explanation (for input 2, T00EF):

T	O		O		E		F	
Unlocked, Unmuted	00	00	00	00	11	10	11	11
	Reserved	Reserved	Reserved	Reserved	Emb. audio presents	Not encrypted	Signal presents	Connected

The Most Common Received Port Status Responses

	T	O		O		A		A	
T00AA	Unlocked, unmuted	00	00	00	00	10	10	10	10
		Reserved	Reserved	Reserved	Reserved	No emb. audio	Not encrypted	No signal	Not connected

	T	O		O		A		B	
T00AB	Unlocked, unmuted	00	00	00	00	10	10	10	11
		Reserved	Reserved	Reserved	Reserved	No emb. audio	Not encrypted	No signal	Connected

	T	O		O		A		F	
T00AF	Unlocked, unmuted	00	00	00	00	10	10	11	11
		Reserved	Reserved	Reserved	Reserved	No emb. audio	Not encrypted	Signal presents	Connected

	T	O		O		E		F	
T00EF	Unlocked, unmuted	00	00	00	00	11	10	11	11
		Reserved	Reserved	Reserved	Reserved	Emb. audio presents	Not encrypted	Signal presents	Connected

	T	O		O		B		F	
T00BF	Unlocked, unmuted	00	00	00	00	10	11	11	11
		Reserved	Reserved	Reserved	Reserved	No emb. audio	Encrypted	Signal presents	Connected

	T	O		O		F		F	
T00FF	Unlocked, unmuted	00	00	00	00	11	11	11	11
		Reserved	Reserved	Reserved	Reserved	Emb. audio presents	Encrypted	Signal presents	Connected

7.5.2. Querying the Status of the Output Ports

Command and Response *#portstatus*

- ▶ GET /MEDIA/VIDEO/XP.DestinationPortStatus
- ◀ pr /MEDIA/VIDEO/XP.DestinationPortStatus=<out1_state>;<out2_state>

The response contains 5 ASCII characters for each output port. The first character indicates the mute/lock state, the next 2-byte long HEX code showing the current state of the output ports. *#portstatus*

Parameters

The structure of the response <out#_state> is the same as the <in#_state> described in the previous section.

Example

- ▶ GET /MEDIA/VIDEO/XP.DestinationPortStatus
- ◀ pr /MEDIA/VIDEO/XP.DestinationPortStatus=M00BF;T00AE

M	O		O		B		F	
Unlocked, Muted	00	00	00	00	10	11	11	11
	Reserved	Reserved	Reserved	Reserved	No emb. audio	Encrypted	Signal presents	Connected

7.5.3. Querying the Video Crosspoint Setting

Command and Response *#crosspoint #switch*

- ▶ GET /MEDIA/VIDEO/XP.DestinationConnectionList
- ◀ pr /MEDIA/VIDEO/XP.DestinationConnectionList=<in>;<in>

The response shows the input ports connected to the output ports: first value is for O1, the second is for O2.

Example

- ▶ GET /MEDIA/VIDEO/XP.DestinationConnectionList
- ◀ pr /MEDIA/VIDEO/XP.DestinationConnectionList=I1;I3

I1 input port is connected to the O1 output port, I3 input port is connected to the O2 output port.

7.5.4. Switching Video Input

Command and Response

- ▶ CALL /MEDIA/VIDEO/XP:switch(<in>;<out>)
- ◀ mO /MEDIA/VIDEO/XP:switch

Example

- ▶ CALL /MEDIA/VIDEO/XP:switch(I2;O1)
- ◀ mO /MEDIA/VIDEO/XP:switch

INFO: When using the '0' value as an input, the input will be disconnected and no signal will appear on the output.

7.5.5. Querying the Video Autoselect Settings

Command and Response *#autoselect*

- ▶ GET /MEDIA/VIDEO/XP.DestinationPortAutoselect
- ◀ pr /MEDIA/VIDEO/XP.DestinationPortAutoselect=<out1_set>;<out2_set>;<out3_set>

The response shows the settings of each output one by one. The structure of the response is the following:

<out#_set> = <state><mode>

Parameters

Parameter	Parameter description	Value	Value description
<state>	The state of the autoselect	E	The autoselect is enabled
		D	The autoselect is disabled
<mode>	The mode of the autoselect	F	First detect mode: the first active video input is selected.
		P	Priority detect mode: always the highest priority active video input will be selected.
		L	Last detect mode: always the last attached input is switched to the output automatically.

Example

- ▶ GET /MEDIA/VIDEO/XP.DestinationPortAutoselect
- ◀ pr /MEDIA/VIDEO/XP.DestinationPortAutoselect=EL;DP;DP

EL: the Autoselect is **Enabled** on the output 1, selected mode is **Last detect**.

DP: the Autoselect is **Disabled** on output 2 and output 3.

INFO: For more information about the Autoselect feature see [The Autoselect Feature](#) section.

7.5.6. Changing the Autoselect Mode

Command and Response

- ▶ CALL /MEDIA/VIDEO/XP:setDestinationPortAutoselect(<out>;<state><mode>)
- ◀ mO /MEDIA/VIDEO/XP:setDestinationPortAutoselect

Parameters

See the previous section. Please note that the mode setting cannot be changed when **D** is sent to change the state to **Disabled**.

INFO: Both or just one parameter can be set as shown in the example below.

Examples

- ▶ CALL /MEDIA/VIDEO/XP:setDestinationPortAutoselect(O1:D;O2:EL)
- ◀ mO /MEDIA/VIDEO/XP:setDestinationPortAutoselect

The Autoselect is switched off on output1, the mode setting is not changed. The Autoselect is switched on on output2, Last detect mode is selected.

7.5.7. Querying the Input Port Priority

Command and Response

- ▶ GET /MEDIA/VIDEO/XP.PortPriorityList
- ◀ pr /MEDIA/VIDEO/XP.PortPriorityList=<out1_list>;<out2_list>

The response shows the priority of each output one after another. The priority number can be from 0 to 3; 0 is the highest- and 3 is the lowest priority.

Parameters

The <out#_list> parameters are the order of the input port priority numbers of the given output port. The structure of these groups is the following:

```
<out#_list> = <in1_prio>,<in2_prio>,<in3_prio>,<in4_prio>
```

Example

- ▶ GET /MEDIA/VIDEO/XP.PortPriorityList
- ◀ pr /MEDIA/VIDEO/XP.PortPriorityList=0,1,2,3;1,0,2,3

There are two outputs, so two groups are listed in the response (divided by semicolons) and each group (list) contains four priority numbers. The values show the priority order of the video input ports:

Output 1				Output 2			
<in1_prio>	<in2_prio>	<in3_prio>	<in4_prio>	<in1_prio>	<in2_prio>	<in3_prio>	<in4_prio>
0	1	2	3	1	0	2	3

In the above example, the input 1 has the highest priority on output 1 and input 4 has the lowest priority. On output 2: the highest priority is assigned to input 2 and the lowest is input 4.

ATTENTION! The same priority number can be set to different input ports. When the priority numbers match, the input port with the lowest port number will have the highest priority.

7.5.8. Changing the Input Port Priority

Command and Response

- ▶ CALL /MEDIA/VIDEO/XP:setAutoselectionPriority(<in>(<out>):<prio>)
- ◀ mO /MEDIA/VIDEO/XP:setAutoselectionPriority

Parameters

The <prio> parameters means the priority number from 0 to 3, equal numbers are allowed. An input port priority can be set on an output port. More parameters can be placed by using a semicolon (no space), see the example below.

Examples

- ▶ CALL /MEDIA/VIDEO/XP:setAutoselectionPriority(I1(O1):3;I2(O1):2)
- ◀ mO /MEDIA/VIDEO/XP:setAutoselectionPriority

The priority number of input 1 has been set to 3 on output 1; the priority number of input 2 has been set to 2 on output 1.

- ▶ CALL /MEDIA/VIDEO/XP:setAutoselectionPriority(I1\O1):3
- ◀ mO /MEDIA/VIDEO/XP:setAutoselectionPriority

The priority number of input 1 has been set to 3 on output 1. The example shows that certain control characters have been escaped: the backslash '\' character is inserted before the '(' and ')' characters. See more information about the escaping in the [Escaping](#) section.

7.5.9. Mute an Input Port

Command and Response

- ▶ CALL /MEDIA/VIDEO/XP:muteSource(<in>)
- ◀ mO /MEDIA/VIDEO/XP:muteSource

Example

- ▶ CALL /MEDIA/VIDEO/XP:muteSource(I1)
- ◀ mO /MEDIA/VIDEO/XP:muteSource

7.5.10. Unmute an Input Port

Command and Response

- ▶ CALL /MEDIA/VIDEO/XP:unmuteSource(<in>)
- ◀ mO /MEDIA/VIDEO/XP:unmuteSource

Example

- ▶ CALL /MEDIA/VIDEO/XP:unmuteSource(I1)
- ◀ mO /MEDIA/VIDEO/XP:unmuteSource

7.5.11. Lock an Input Port

Command and Response *#lock #unlock #mute #unmute*

- ▶ CALL·/MEDIA/VIDEO/XP:lockSource(<in>)
- ◀ mO·/MEDIA/VIDEO/XP:lockSource

Example

- ▶ CALL /MEDIA/VIDEO/XP:lockSource(I1)
- ◀ mO /MEDIA/VIDEO/XP:lockSource

7.5.12. Unlock an Input Port

Command and Response

- ▶ CALL·/MEDIA/VIDEO/XP:unlockSource(<in>)
- ◀ mO·/MEDIA/VIDEO/XP:unlockSource

Example

- ▶ CALL /MEDIA/VIDEO/XP:unlockSource(I1)
- ◀ mO /MEDIA/VIDEO/XP:unlockSource

7.5.13. Mute an Output Port

Command and Response

- ▶ CALL·/MEDIA/VIDEO/XP:muteDestination(<out>)
- ◀ mO·/MEDIA/VIDEO/XP:muteDestination

Example

- ▶ CALL /MEDIA/VIDEO/XP:muteDestination(O1)
- ◀ mO /MEDIA/VIDEO/XP:muteDestination

7.5.14. Unmute an Output Port

Command and Response

- ▶ CALL·/MEDIA/VIDEO/XP:unmuteDestination(<out>)
- ◀ mO·/MEDIA/VIDEO/XP:unmuteDestination

Example

- ▶ CALL /MEDIA/VIDEO/XP:unmuteDestination(O1)
- ◀ mO /MEDIA/VIDEO/XP:unmuteDestination

7.5.15. Lock an Output Port

Command and Response

- ▶ CALL·/MEDIA/VIDEO/XP:lockDestination(<out>)
- ◀ mO·/MEDIA/VIDEO/XP:lockDestination

Example

- ▶ CALL /MEDIA/VIDEO/XP:lockDestination(O1)
- ◀ mO /MEDIA/VIDEO/XP:lockDestination

7.5.16. Unlock an Output Port

Command and Response

- ▶ CALL·/MEDIA/VIDEO/XP:unlockDestination(<out>)
- ◀ mO·/MEDIA/VIDEO/XP:unlockDestination

Example

- ▶ CALL /MEDIA/VIDEO/XP:unlockDestination(O1)
- ◀ mO /MEDIA/VIDEO/XP:unlockDestination

7.5.17. HDCP Setting (Input Port)

HDCP capability can be enabled/disabled on the input ports, thus, non-encrypted content can be seen on a non-HDCP compliant display. See more information in the [HDCP Management](#) section.

Command and Response *#hdcp*

- ▶ SET·/MEDIA/VIDEO/<in>.HdcpEnable=<hdcp_status>
- ◀ pw·/MEDIA/VIDEO/<in>.HdcpEnable=<hdcp_status>

Parameters

If the <hdcp_status> parameter is **true**, HDCP is enabled, if **false**, then HDCP is disabled.

Example

- ▶ SET /MEDIA/VIDEO/I2.HdcpEnable=true
- ◀ pw /MEDIA/VIDEO/I2.HdcpEnable=true

7.5.18. HDCP Setting (Output Port)

HDCP capability can be set to Auto/Always on the output ports, thus, non-encrypted content can be transmitted to a non-HDCP compliant display. See more information in the [HDCP Management](#) section.

Command and Response *#hdcp*

- ▶ SET /MEDIA/VIDEO/<out>.HdcpModeSetting=<hdcp_mode>
- ◀ pw /MEDIA/VIDEO/<out>.HdcpModeSetting=<hdcp_mode>

Parameters

Parameter	Parameter description	Values	Value description
<hdcp_mode>	HDCP encryption setting on the output port	0	Auto: The encryption is enabled on the output port if the signal on the input port is encrypted.
		1	Always: The outgoing signal is HDCP-encrypted.

Example

- ▶ SET /MEDIA/VIDEO/O1.HdcpModeSetting=0
- ◀ pw /MEDIA/VIDEO/O1.HdcpModeSetting=0

7.5.19. Test Pattern Generator

The output ports can send a special image towards the sink devices for testing purposes. The setting is available on output ports with the below-listed parameters. *#nosyncscreen #testpattern*

ATTENTION! The Mode can be set individually on each port, but the Clock source and the Pattern settings are common on the optical and HDMI output ports (O1 and O2).

7.5.19.1. Test Pattern Generator Mode Setting

Command and Response

- ▶ SET /MEDIA/VIDEO/<out>.TpgMode=<tpg_mode>
- ◀ pw /MEDIA/VIDEO/<out>.TpgMode=<tpg_mode>

Parameters

Parameter	Parameter description	Values	Value description
<tpg_mode>	Test pattern generator mode	0	Disabled: the test pattern is not displayed on the output.
		1	Enabled: the test pattern is displayed on the output.
		2	No signal mode: the test pattern is displayed if there is no signal on the output port.

Example

- ▶ SET /MEDIA/VIDEO/O1.TpgMode=2
- ◀ pw /MEDIA/VIDEO/O1.TpgMode=2

7.5.19.2. The Clock Frequency of the Test Pattern

Command and Response

- ▶ SET /MEDIA/VIDEO/<out>.TpgClockSource=<tpg_clock>
- ◀ pw /MEDIA/VIDEO/<out>.TpgClockSource=<tpg_clock>

Parameters

Parameter	Parameter description	Values	Value description
<tpg_clock>	Clock frequency of the test pattern signal	480	480p
		576	576p
		EXT	External clock: coming from the actual TMDS source.

Example

- ▶ SET /MEDIA/VIDEO/O1.TpgClockSource=576
- ◀ pw /MEDIA/VIDEO/O1.TpgClockSource=576

7.5.19.3. Test Pattern

Command and Response

- ▶ SET /MEDIA/VIDEO/<out>.TpgPattern=<pattern>
- ◀ pw /MEDIA/VIDEO/<out>.TpgPattern=<pattern>

Parameters

The <pattern> can be: RED; GREEN; BLUE; BLACK; WHITE; RAMP; CHESS; BAR; CYCLE

Cycle setting means all the patterns are changed sequentially approx. in every 2 seconds.

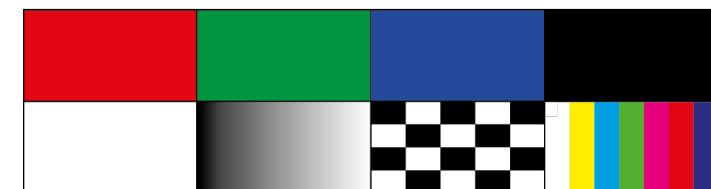

Example

- ▶ SET /MEDIA/VIDEO/O1.TpgPattern=GREEN
- ◀ pw /MEDIA/VIDEO/O1.TpgPattern=GREEN

7.5.20. HDMI Mode Settings (Output Port)

Command and Response *#signaltype*

- ▶ SET·/MEDIA/VIDEO/<out>.HdmiModeSetting=<hdmi_mode>
- ◀ pw·/MEDIA/VIDEO/<out>.HdmiModeSetting=<hdmi_mode>

Parameters

Parameter	Parameter description	Values	Value description
<hdmi_mode>	HDMI mode setting	0	Auto: the mode is determined automatically based on the EDID of the connected sink device.
		1	DVI: setting the outgoing signal type to DVI.
		2	HDMI: setting the outgoing signal type to HDMI.

Example

- ▶ SET /MEDIA/VIDEO/O1.HdmiModeSetting=2
- ◀ pw / MEDIA/VIDEO/O1.HdmiModeSetting=2

7.5.21. Querying the Recent TPS Mode

DIFFERENCE: The command is valid for MMX4x2-HT200 model only.

Command and Response *#tpsmode*

- ▶ GET·/REMOTE/<tps_port>.tpsMode
- ◀ pr·/REMOTE/<tps_port>.tpsMode=<tps_mode>

Parameters

Parameter	Parameter description	Values	Value description
<tps_port>	Port number	S1	TPS input port number
<tps_mode>	TPS transmission mode	A	Auto: The TPS mode is determined automatically.
		H	HDBaseT: Ideal for high resolution signals up to 4K.
		L	Long reach: Ideal for big distances up to 1080p@60Hz with extended cable lengths.
		1	LPPF1*: Only RS-232 communication is transmitted (@ 9600 baud)
		2	LPPF2*: Only RS-232 (@ 9600 baud) and Ethernet communication are transmitted.

* LPPF: Low Power Partial Functionality.

Example

- ▶ GET /REMOTE/S1.tpsMode
- ◀ pr /REMOTE/S1.tpsMode=H

See more information about TPS modes in the [Consuming Electronics Control \(CEC\) Interface](#) section.

7.5.22. TPS Mode Settings

DIFFERENCE: The command is valid for MMX4x2-HT200 model only.

The TPS working mode between the transmitter and the receiver is determined by the mode set in them. Both devices TPS mode settings together determine the finally established TPS transmission mode.

Command and Response

- ▶ SET·/REMOTE/<tps_port>.tpsModeSetting=<tps_mode>
- ◀ pw·/REMOTE/<tps_port>.tpsModeSetting=<tps_mode>

Parameters

See at previous section.

Example

- ▶ SET /REMOTE/S1.tpsModeSetting=A
- ◀ pw /REMOTE/S1.tpsModeSetting=A

7.6. Audio Port Settings frm Firmware v1.2.0

ATTENTION! The audio port setting commands depend on the installed firmware version of the device. If your device is installed with firmware v1.1.0, see the [Audio Port Settings for Firmware v1.1.0](#) section. The following LW3 commands are related to firmware v1.2.0 and above. To query the firmware version of your device, see the [Querying the Firmware Version](#) section. You can find the complete list of the changes in the [LW3 Command Changes in Firmware v1.2.0](#) section.

INFO: Audio port numbering can be found in the [Input/Output Port Numbering](#) section.

7.6.1. Querying the Status of Source Port

Command and Response #portstatus

- ▶ GET /MEDIA/AUDIO/XP.SourcePortStatus
- ◀ pr /MEDIA/AUDIO/XP.SourcePortStatus=<audio_in1_state>;<audio_in2_state>;<audio_in3_state>

Parameters

<audio_in#_state>: The response contains 5 ASCII characters for each port. The first character indicates the mute/lock state, the next four characters represent a 2-byte HEX code showing the current state of the input ports.

Example

- ▶ GET /MEDIA/AUDIO/XP.SourcePortStatus
- ◀ pr /MEDIA/AUDIO/XP.SourcePortStatus=T00C;T0008;M000F

Legend

Letter (Character 1)		
	Mute state	Lock state
T	Unmuted	Unlocked
L	Unmuted	Locked
M	Muted	Unlocked
U	Muted	Locked

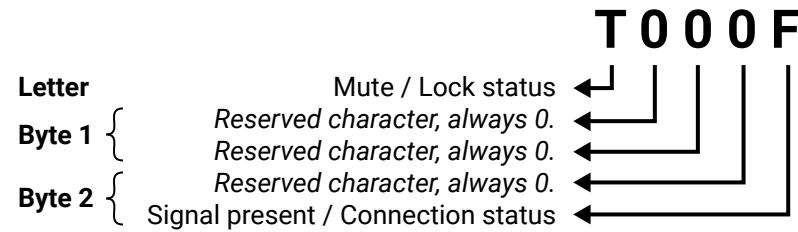

	Byte 1				Byte 2			
	Character 2		Character 3		Character 4		Character 5	
	BIT 7-6	BIT 5-4	BIT 3-2	BIT 1-0	BIT 7-6	BIT 5-4	BIT 3-2	BIT 1-0
	Reserved	Reserved	Reserved	Reserved	Reserved	Reserved	Signal present status	Connection status
00	Reserved	Reserved	Reserved	Reserved	Reserved	Reserved	Unknown	
01							Reserved	
10							No signal	Not connected
11							Signal presents	Connected

Example and Explanation (for input 3, M000F):

M	0		0		0		F	
Unlocked, Muted	00	00	00	00	00	00	11	11
	Reserved	Reserved	Reserved	Reserved	Reserved	Reserved	Signal presents	Connected

The Most Common Received Port Status Responses

T000A	T	0		0		0		A	
Unlocked, Unmuted	00	00	00	00	00	00	00	10	10
	Reserved	Reserved	Reserved	Reserved	Reserved	Reserved	Reserved	No signal	Not connected

T000B	T	0		0		0		B	
Unlocked, Unmuted	00	00	00	00	00	00	00	10	11
	Reserved	Reserved	Reserved	Reserved	Reserved	Reserved	Reserved	No signal	Connected

T000F	T	0		0		0		F	
Unlocked, Unmuted	00	00	00	00	00	00	00	11	11
	Reserved	Reserved	Reserved	Reserved	Reserved	Reserved	Reserved	Signal presents	Connected

Only for A1 and A2 logical audio ports: If the character 5 is C (11 00) which means signal is present but the cable connection status is unknown - the explanation is a logical port has no pin which can indicate the connection status so this is always unknown. When the character 5 is 8 (10 00), that means there is no signal on the port.

T0008	T	0		0		0		8	
Unlocked, Unmuted	00	00	00	00	00	00	00	10	00
	Reserved	Reserved	Reserved	Reserved	Reserved	Reserved	Reserved	No signal	Unknown

T000C	T	0		0		0		C	
Unlocked, Unmuted	00	00	00	00	00	00	00	11	00
	Reserved	Reserved	Reserved	Reserved	Reserved	Reserved	Reserved	Signal presents	Unknown

7.6.2. Querying the Status of Destination Port

Command and Response *#portstatus*

- ▶ GET /MEDIA/AUDIO/XP.DestinationPortStatus
- ◀ pr /MEDIA/AUDIO/XP.DestinationPortStatus=<a_out1_state>;<a_out2_state>;<a_out3_state>

The response contains 5 ASCII characters for each port. The first character indicates the mute/lock state, the next 2-byte long HEX code showing the current state of the output port.

Parameters

See at previous section.

Legend (for output 2, M000F):

M	0		0		0		F	
Unlocked,	00	00	00	00	00	00	11	11
Muted	Reserved	Reserved	Reserved	Reserved	Reserved	Reserved	Signal presents	Connected

Example

- ▶ GET /MEDIA/AUDIO/XP.DestinationPortStatus
- ◀ pr /MEDIA/AUDIO/XP.DestinationPortStatus=T000F;T000F;M000F

7.6.3. Querying the Audio Crosspoint State

Command and Response

- ▶ GET /MEDIA/AUDIO/XP.DestinationConnectionList
- ◀ pr /MEDIA/AUDIO/XP.DestinationConnectionList=<audio_in1>;<audio_in2>;<audio_in3>

Parameters

The <audio_in#> parameter means the audio input port number (A1-A3).

Example

- ▶ GET /MEDIA/AUDIO/XP.DestinationConnectionList
- ◀ pr /MEDIA/AUDIO/XP.DestinationConnectionList=A1;A2;A2

A1 input port is connected to output1, A2 input port is connected to output 2 and output3 ports.

7.6.4. Switching Audio Input

Command and Response

- ▶ CALL /MEDIA/AUDIO/XP:switch(<audio_in>;<audio_out>)
- ◀ m0 /MEDIA/AUDIO/XP:switch

Parameters

Parameter	Parameter description	Values	Parameter values
<audio_in>	Audio input port	A1-A3	For inputs
<audio_out>	Audio output port	O1-O3	For outputs

Example

- ▶ CALL /MEDIA/AUDIO/XP:switch(A2;O1)
- ◀ m0 /MEDIA/AUDIO/XP:switch

A2 port is connected to O1 port.

7.6.5. Querying the Audio Autoselect Settings

Command and Response *#autoselect*

- ▶ GET /MEDIA/AUDIO/XP.DestinationPortAutoselect
- ◀ pr /MEDIA/AUDIO/XP.DestinationPortAutoselect=<out1_set>;<out2_set>;<out3_set>

The response shows the settings of each output one by one. The structure of the response is the following:

<out#_set> = <state><mode>

Parameters

Parameter	Parameter description	Value	Value description
<state>	The state of the autoselect	E	The autoselect is enabled
		D	The aut oselect is disabled
<mode>	The mode of the autoselect	F	First detect mode: the first active video input is selected.
		P	Priority detect mode: always the highest priority active video input will be selected.
		L	Last detect mode: always the last attached input is switched to the output automatically.

Example

- ▶ GET /MEDIA/AUDIO/XP.DestinationPortAutoselect
- ◀ pr /MEDIA/AUDIO/XP.DestinationPortAutoselect=EL;DP;DP

EL: the Autoselect is Enabled on output1, selected mode is Last detect. The Autoselect is disabled on the other ports.

INFO: For more information about the Autoselect feature see [The Autoselect Feature](#) section.

7.6.6. Changing the Autoselect Mode

Command and Response

- ▶ `CALL /MEDIA/AUDIO/XP:setDestinationPortAutoselect(<out>:<state><mode>)`
- ◀ `mO /MEDIA/AUDIO/XP:setDestinationPortAutoselect`

Parameters

See at previous section. Please note that the mode setting cannot be changed when **D** is sent to change the state to **Disabled**.

Example1

- ▶ `CALL /MEDIA/AUDIO/XP:setDestinationPortAutoselect(O1:EP)`
- ◀ `mO /MEDIA/AUDIO/XP:setDestinationPortAutoselect`

The setting is changed to **EP** at output1: Autoselect is enabled (E) and the mode is set to **priority detect** (P).

Example2

- ▶ `CALL /MEDIA/AUDIO/XP:setDestinationPortAutoselect(O1:D)`
- ◀ `mO /MEDIA/AUDIO/XP:setDestinationPortAutoselect`

The setting is changed to **D** at output1: Autoselect is disabled (D). The other settings remain unchanged.

■ **INFO:** For more information about the Autoselect feature see [The Autoselect Feature](#) section.

7.6.7. Querying the Input Port Priority

Command and Response

- ▶ `GET /MEDIA/AUDIO/XP.PortPriorityList`
- ◀ `pr /MEDIA/AUDIO/XP.PortPriorityList=<out1_list>;<out2_list>;<out3_list>`

The response shows the priority of each output one after another. The priority number can be from 0 to 2; 0 is the highest- and 2 is the lowest priority.

Parameters

The `<out#_list>` parameters are the order of the input port priority numbers of the given output port. The structure of these groups is the following:

```
<out#_list> = <in1_prio>,<in2_prio>,<in3_prio>,<in4_prio>
```

Example

- ▶ `GET /MEDIA/AUDIO/XP.PortPriorityList`
- ◀ `pr /MEDIA/AUDIO/XP.PortPriorityList=0,1,2;0,1,2;1,0,2`

There are three outputs, so three groups are listed in the response (divided by semicolons) and each group (list) contains three priority numbers. The values show the priority order of the video input ports.

Output 1			Output 2			Output 3		
<in1_prio>	<in2_prio>	<in3_prio>	<in1_prio>	<in2_prio>	<in3_prio>	<in1_prio>	<in2_prio>	<in3_prio>
0	1	2	0	1	2	1	0	2

In the above example, the default setting can be seen at output 1 and output 2: input 1 has the highest priority. On output 3 the highest priority is assigned to input 2.

■ **ATTENTION!** The same priority number can be set to different input ports. When the priority numbers match, the input port with the lowest port number will have the highest priority.

7.6.8. Changing the Input Port Priority

Command and Response

- ▶ `CALL /MEDIA/AUDIO/XP:setAutoselectionPriority(<in>(<out>):<prio>)`
- ◀ `mO /MEDIA/AUDIO/XP:setAutoselectionPriority`

Parameters

The `<prio>` parameters means the priority number from 0 to 2, equal numbers are allowed. An input port priority can be set on an output port. More parameters can be placed by using a semicolon (no space), see the example below.

Examples

- ▶ `CALL /MEDIA/AUDIO/XP:setAutoselectionPriority(I1(O1):2;I2(O1):1)`
- ◀ `mO /MEDIA/AUDIO/XP:setAutoselectionPriority`

The priority number of input 1 has been set to 2 on output 1; the priority number of input 2 has been set to 1 on output 1.

- ▶ `CALL /MEDIA/AUDIO/XP:setAutoselectionPriority(I1\ (O1)\:2)`
- ◀ `mO /MEDIA/AUDIO/XP:setAutoselectionPriority`

The priority number of input 1 has been set to 2 on output 1. The example shows that certain control characters have been escaped: the backslash `\` character is inserted before the `(` and `)` characters. See more information about the escaping in the [Escaping](#) section.

7.6.9. Mute an Audio Input

Command and Response `#lock #unlock #mute #unmute`

- ▶ `CALL /MEDIA/AUDIO/XP:muteSource(<audio_in>)`
- ◀ `mO /MEDIA/AUDIO/XP:muteSource`

Parameters

The `<audio_in>` parameter is the Audio input port number and can be A1, A2 or A3.

Example

- ▶ `CALL /MEDIA/AUDIO/XP:muteSource(A1)`
- ◀ `mO /MEDIA/AUDIO/XP:muteSource`

7.6.10. Unmute an Audio Input

Command and Response

- ▶ CALL·/MEDIA/AUDIO/XP:unmuteSource(<audio_in>)
- ◀ mO·/MEDIA/AUDIO/XP:unmuteSource

Parameters

The <audio_in> parameter is the Audio input port number and can be A1, A2 or A3.

Example

- ▶ CALL /MEDIA/AUDIO/XP:unmuteSource(A1)
- ◀ mO /MEDIA/AUDIO/XP:unmuteSource

7.6.11. Lock an Input Port

Command and Response

- ▶ CALL·/MEDIA/AUDIO/XP:lockSource(<audio_in>)
- ◀ mO·/MEDIA/AUDIO/XP:lockSource

Parameters

The <audio_in> parameter is the Audio input port number and can be A1, A2 or A3.

Example

- ▶ CALL /MEDIA/AUDIO/XP:lockSource(A1)
- ◀ mO /MEDIA/AUDIO/XP:lockSource

7.6.12. Unlock an Input Port

Command and Response

- ▶ CALL·/MEDIA/AUDIO/XP:unlockSource(<audio_in>)
- ◀ mO·/MEDIA/AUDIO/XP:unlockSource

Parameters

The <audio_in> parameter is the Audio input port number and can be A1, A2 or A3.

Example

- ▶ CALL /MEDIA/AUDIO/XP:unlockSource(A1)
- ◀ mO /MEDIA/AUDIO/XP:unlockSource

7.6.13. Mute an Audio Output Port

Command and Response

- ▶ CALL·/MEDIA/AUDIO/XP:muteDestination(<audio_out>)
- ◀ mO·/MEDIA/AUDIO/XP:muteDestination

Parameters

The <audio_out> parameter is the Audio output port number and can be O1, O2 or O3.

Example

- ▶ CALL /MEDIA/AUDIO/XP:muteDestination(O1)
- ◀ mO /MEDIA/AUDIO/XP:muteDestination

7.6.14. Unmute an Audio Output Port

Command and Response

- ▶ CALL·/MEDIA/AUDIO/XP:unmuteDestination(<audio_out>)
- ◀ mO·/MEDIA/AUDIO/XP:unmuteDestination

Parameters

The <audio_out> parameter is the Audio output port number and can be O1, O2 or O3.

Example

- ▶ CALL /MEDIA/AUDIO/XP:unmuteDestination(O1)
- ◀ mO /MEDIA/AUDIO/XP:unmuteDestination

7.6.15. Lock an Audio Output Port

Command and Response

- ▶ CALL /MEDIA/AUDIO/XP:lockDestination(<audio_out>)
- ◀ mO /MEDIA/AUDIO/XP:lockDestination

Parameters

The <audio_out> parameter is the Audio output port number and can be 01, 02 or 03.

Example

- ▶ CALL /MEDIA/AUDIO/XP:lockDestination(01)
- ◀ mO /MEDIA/AUDIO/XP:lockDestination

7.6.16. Unlock an Audio Output Port

Command and Response

- ▶ CALL /MEDIA/AUDIO/XP:unlockDestination(<audio_out>)
- ◀ mO /MEDIA/AUDIO/XP:unlockDestination

Parameters

The <audio_out> parameter is the Audio output port number and can be 01, 02 or 03.

Example

- ▶ CALL /MEDIA/AUDIO/XP:unlockDestination(01)
- ◀ mO /MEDIA/AUDIO/XP:unlockDestination

7.6.17. Analog Audio Input Gain Setting

Command and Response

- ▶ SET /MEDIA/AUDIO/A3.Gain=<level>
- ◀ pw /MEDIA/AUDIO/A3.Gain=<level>

Parameters

The <level> parameter sets the input gain between -12 dB and 6 dB in step of 3 dB. The value is rounded down if necessary to match with the step value.

Example

- ▶ SET /MEDIA/AUDIO/A3.Gain=3
- ◀ pw /MEDIA/AUDIO/A3.Gain=3.00

7.6.18. Analog Audio Output Level Settings by Exact Values

7.6.18.1. Setting the Volume (dB)

Command and Response *#analogaudio #volume*

- ▶ SET /MEDIA/AUDIO/O3.VoluedB=<level>
- ◀ pw /MEDIA9/AUDIO/O3.VoluedB=<level>

Parameters

The <level> parameters sets the output volume (attenuation) between -57 dB and 0 dB in step of -0.375 dB. The value is rounded up if necessary to match with the step value.

Example

- ▶ SET /MEDIA/AUDIO/O3.VoluedB=-15
- ◀ pw /MEDIA/AUDIO/O3.VoluedB=-15.00

7.6.18.2. Setting the Volume (Percent)

Command and Response

- ▶ SET /MEDIA/AUDIO/O3.VolumePercent=<percent>
- ◀ pw /MEDIA/AUDIO/O3.VolumePercent=<percent>

Parameters

The <percent> parameter sets the output volume (attenuation) between 100% and 0%, in step of 1%. The value is rounded up if necessary to match with the step value.

Example

- ▶ SET /MEDIA/AUDIO/O3.VolumePercent=50
- ◀ pw /MEDIA/AUDIO/O3.VolumePercent=50.00

7.6.18.3. Setting the Balance

Command and Response *#balance*

- ▶ SET /MEDIA/AUDIO/O3.Balance=<level>
- ◀ pw /MEDIA/AUDIO/O3.Balance=<level>

Parameters

The <level> parameter sets the balance; -100 means left balance, 100 means right balance, step is 1. Center is 0 (default).

Example

- ▶ SET /MEDIA/AUDIO/O3.Balance=0
- ◀ pw /MEDIA/AUDIO/O3.Balance=0

7.6.19. Analog Audio Output Level Settings by Steps

7.6.19.1. Volume Setting (dB)

Command and Response *#analogaudio #volume*

- ▶ CALL /MEDIA/AUDIO/O3:stepVolumedB=<step>
- ◀ m0 /MEDIA/AUDIO/O3:stepVolumedB

Parameters

The volume is increased or decreased with the given <step> value in dB.

Example

- ▶ CALL /MEDIA/AUDIO/O3:stepVolumedB(-1)
- ◀ m0 /MEDIA/AUDIO/O3:stepVolumedB

The volume is decreased with 1 dB, the current volume is -1.95 dB which means 77.84% in percent.

7.6.19.2. Volume Setting in Percent

Command and Response

- ▶ CALL /MEDIA/AUDIO/O3:stepVolumePercent=<step>
- ◀ m0 /MEDIA/AUDIO/O3:stepVolumePercent

Parameters

The volume is increased or decreased by the given <step> value in percent.

Example

- ▶ CALL /MEDIA/AUDIO/O3:stepVolumePercent(5)
- ◀ m0 /MEDIA/AUDIO/O3:stepVolumePercent

The volume is increased with 5%, the current volume is -1.52 dB which means 82.84% in percent.

7.7. Audio Port Settings for Firmware v1.1.0

ATTENTION! The audio port setting commands depend on the installed firmware version of the device. If your device is installed with firmware v1.2.0, see the [Audio Port Settings frm Firmware v1.2.0](#) section. The following LW3 commands are related to firmware v1.1.0. To query the firmware version of your device, see the [Querying the Firmware Version](#) section. You can find the complete list of the changes in the [LW3 Command Changes in Firmware v1.2.0](#) section.

INFO: Audio port numbering can be found in the [Input/Output Port Numbering](#) section.

7.7.1. Set Audio Source of HDMI Output 1

The HDMI out 1 port can transmit the original embedded audio line or the analog audio from the analog audio input line.

Command and Response

- ▶ SET /SYS/MB/LEGACYAUDIOXP.EmbedAudioInputToHdmiOut1=<embed_audio>
- ◀ pw /SYS/MB/LEGACYAUDIOXP.EmbedAudioInputToHdmiOut1=<embed_audio>

Parameters

Parameter	Parameter description	Value	Value description
<embed_audio>	Audio source of HDMI out 1 (O1)	true	Analog audio line from input port I5 is embedded to O1
		false	Original embedded HDMI audio is transmitted to O1

Example

- ▶ SET /SYS/MB/LEGACYAUDIOXP.EmbedAudioInputToHdmiOut1=false
- ◀ pw /SYS/MB/LEGACYAUDIOXP.EmbedAudioInputToHdmiOut1=false

HDMI out 1 transmits the original audio line of HDMI signal from the selected input port.

7.7.2. Set Audio Source of HDMI Output 2

The HDMI out 2 port can transmit the original embedded audio line or the analog audio from the analog audio input line.

Command and Response

- ▶ SET /SYS/MB/LEGACYAUDIOXP.EmbedAudioInputToHdmiOut2=<embed_audio>
- ◀ pw /SYS/MB/LEGACYAUDIOXP.EmbedAudioInputToHdmiOut2=<embed_audio>

Parameters

Parameter	Parameter description	Value	Value description
<embed_audio>	Audio source of HDMI out 2 (O2)	true	Analog audio line from input port I5 is embedded to O2
		false	Original embedded HDMI audio is transmitted to O2

Example

- ▶ SET /SYS/MB/LEGACYAUDIOXP.EmbedAudioInputToHdmiOut2=true
- ◀ pw /SYS/MB/LEGACYAUDIOXP.EmbedAudioInputToHdmiOut2=true

HDMI out 2 transmits the analog audio signal from input port I5 which is embedded to the HDMI signal.

7.7.3. Set Audio Source of Analog Audio Output

The Analog audio out port can transmit the analog audio from the analog audio input line or the de-embedded audio from the HDMI out 2.

Command and Response

- ▶ SET /SYS/MB/LEGACYAUDIOXP.EnableAnalogPassthrough=<passthrough_status>
- ◀ pw /SYS/MB/LEGACYAUDIOXP.EnableAnalogPassthrough=<passthrough_status>

Parameters

Parameter	Parameter description	Value	Value description
<passthrough_status>	Audio source of Analog audio out (O3)	true	Analog audio of Analog audio input is transmitted to Analog audio out.
		false	HDMI audio of HDMI out 2 is de-embedded to Analog Audio out.

Example

- ▶ SET /SYS/MB/LEGACYAUDIOXP.EnableAnalogPassthrough=false
- ◀ pw /SYS/MB/LEGACYAUDIOXP.EnableAnalogPassthrough=false

The digital audio which is selected to HDMI out 2 is de-embedded and transmitted to the Analog audio out port.

7.7.4. Mute/Unmute Analog Audio Input

Command and Response

- ▶ SET /MEDIA/AUDIO/<audio_in>.Mute=<mute_status>
- ◀ pw /MEDIA/AUDIO/<audio_in>.Mute=<mute_status>

Parameters

Parameter	Parameter description	Value	Value description
<audio_in>	Audio input port number	I1-I5	
		true	The audio port is muted.
		false	The audio port is not muted.

Example

- ▶ SET /MEDIA/AUDIO/I5.Mute=false
- ◀ pw /MEDIA/AUDIO/I5.Mute=false

7.7.5. Mute/Unmute Analog Audio Output

Command and Response

- ▶ SET /MEDIA/AUDIO/<audio_out>.Mute=<mute_status>
- ◀ pw /MEDIA/AUDIO/<audio_out>.Mute=<mute_status>

Parameters

Parameter	Parameter description	Value	Value description
<audio_out>	Audio output port number	O1-O3	
		true	The audio port is muted.
		false	The audio port is not muted.

Example

- ▶ SET /MEDIA/AUDIO/O3.Mute=false
- ◀ pw /MEDIA/AUDIO/O3.Mute=false

7.7.6. Analog Audio Input Level Settings by Exact Values

7.7.6.1. Setting the Volume (dB)

Command and Response *#analogaudio #volume*

- ▶ SET·/MEDIA/AUDIO/<audio_in>.VolumedB=<level>
- ◀ pw·/MEDIA/AUDIO/<audio_in>.VolumedB=<level>

Parameters

Parameter	Parameter description	Values	Value description
<audio_in>	Audio input port number	I1-I5	
<level>	The input volume (attenuation) in dB	Number between -95.625 and 0 in step of -0.375.	The value is rounded up if necessary to match with the step value.

Example

- ▶ SET /MEDIA/AUDIO/I5.VolumedB=-15
- ◀ pw /MEDIA/AUDIO/I5.VolumedB=-15.00

7.7.6.2. Setting the Volume (Percent)

Command and Response

- ▶ SET·/MEDIA/AUDIO/<audio_in>.VolumePercent=<percent>
- ◀ pw·/MEDIA/AUDIO/<audio_in>.VolumePercent=<percent>

Parameters

Parameter	Parameter description	Values	Value description
<audio_in>	Audio input port number	I1-I5	
<percent>	The input volume (attenuation) in percent	Number between 0 and 100 in step of 1.	The value is rounded up if necessary to match with the step value.

Example

- ▶ SET /MEDIA/AUDIO/I5.VolumePercent=50
- ◀ pw /MEDIA/AUDIO/I5.VolumePercent=50.00

7.7.6.3. Setting the Balance

Command and Response *#balance*

- ▶ SET·/MEDIA/AUDIO/<audio_in>.Balance=<level>
- ◀ pw·/MEDIA/AUDIO/<audio_in>.Balance=<level>

Parameters

Parameter	Parameter description	Values	Value description
<audio_in>	Audio input port number	I1-I5	
<level>	The input signal balance setting	Number between -100 and 100 in step of 1.	-100 means left balance, 100 means right balance. Center is 0 (default).

Example

- ▶ SET /MEDIA/AUDIO/I5.Balance=10
- ◀ pw /MEDIA/AUDIO/I5.Balance=10

7.7.6.4. Setting the Gain

Command and Response

- ▶ SET·/MEDIA/AUDIO/<audio_in>.Gain=<level>
- ◀ pw·/MEDIA/AUDIO/<audio_in>.Gain=<level>

Parameters

Parameter	Parameter description	Values	Value description
<audio_in>	Audio input port number	I1-I5	
<level>	The input signal gain in dB	Number between -12 and 6 in step of 3.	The value is rounded down if necessary to match the step value.

Example

- ▶ SET /MEDIA/AUDIO/I5.Gain=3
- ◀ pw /MEDIA/AUDIO/I5.Gain=3.00

7.7.7. Analog Audio Input Level Settings by Steps

7.7.7.1. Setting the Volume (dB)

Command and Response *#analogaudio #volume*

- ▶ CALL·/MEDIA/AUDIO/<audio_in>:stepVolumedB(<step>)
- ◀ m0·/MEDIA/AUDIO/<audio_in>:stepVolumedB

Parameters

Parameter	Parameter description	Values	Parameter values
<audio_in>	Audio input port number	I1-I5	
<step>	Gain setting in dB		Volume is increased or decreased by the given value in dB.

Example

- ▶ CALL /MEDIA/AUDIO/I5:stepVolumedB(-1)
- ◀ m0 /MEDIA/AUDIO/I5:stepVolumedB

The volume is decreased with 1 dB, the current volume is -1 dB which means 91.21% in percent.

7.7.7.2. Setting the Volume (in Percent)

Command and Response

- ▶ CALL·/MEDIA/AUDIO/<audio_in>:stepVolumePercent(<step>)
- ◀ m0·/MEDIA/AUDIO/<audio_in>:stepVolumePercent

Parameters

Parameter	Parameter description	Values	Parameter values
<audio_in>	Audio input port number	I1-I5	
<step>	The input volume (attenuation) in percent		Volume is increased or decreased by the given value in percent.

Example

- ▶ CALL /MEDIA/AUDIO/I5:stepVolumePercent(5)
- ◀ m0 /MEDIA/AUDIO/I5:stepVolumePercent

The volume is increased with 5%, the current volume is -0.83 dB which means 95% in percent.

7.7.7.3. Setting the Balance

Command and Response *#balance*

- ▶ CALL·/MEDIA/AUDIO/<audio_in>:stepBalance(<step>)
- ◀ m0·/MEDIA/AUDIO/<audio_in>:stepBalance

Parameters

Parameter	Parameter description	Values	Value description
<audio_in>	Audio input port number	I1-I5	
<step>	The input signal balance setting	Number between -100 and 100 in step of 1.	Balance is shifted to left or right depends on the given value. -100 means left balance, 100 means right balance. Center is 0 (default).

Example

- ▶ CALL /MEDIA/AUDIO/I5:stepBalance(1)
- ◀ m0 /MEDIA/AUDIO/I5:stepBalance

The balance is shifted to right with 1 step.

7.7.8. Analog Audio Output Level Settings

7.7.8.1. Setting the Volume (dB)

Command and Response *#analogaudio #volume*

- ▶ SET·/MEDIA/AUDIO/<audio_out>.VolumedB=<level>
- ◀ pw·/MEDIA/AUDIO/<audio_out>.VolumedB=<level>

Parameters

Parameter	Parameter description	Values	Value description
<audio_out>	Audio output port number	O1, O2, O3	
<level>	The output volume (attenuation) in dB	Number between -57 and 0 in step of -0.375.	The value is rounded up if necessary to match with the step value.

Example

- ▶ SET /MEDIA/AUDIO/O3.VolumedB=-15
- ◀ pw /MEDIA/AUDIO/O3.VolumedB=-15.00

7.7.8.2. Setting the Volume (Percent)

Command and Response *#volume*

- ▶ SET /MEDIA/AUDIO/<audio_out>.VolumePercent=<percent>
- ◀ pw /MEDIA/AUDIO/<audio_out>.VolumePercent=<percent>

Parameters

Parameter	Parameter description	Values	Value description
<audio_out>	Audio output port number	01, 02, 03	
<percent>	The output volume (attenuation) in percent	Number between 0 and 100 in step of 1	The value is rounded up if necessary to match with the step value.

Example

- ▶ SET /MEDIA/AUDIO/03.VolumePercent=50
- ◀ pw /MEDIA/AUDIO/03.VolumePercent=50.00

7.7.8.3. Setting the Balance

Command and Response *#balance*

- ▶ SET /MEDIA/AUDIO/<audio_out>.Balance=<level>
- ◀ pw /MEDIA/AUDIO/<audio_out>.Balance=<level>

Parameters

Parameter	Parameter description	Values	Value description
<audio_out>	Audio output port number	01, 02, 03	
<level>	The output signal balance	Number between -100 and 100 in step of 1	Center setting is 0 (default).

Example

- ▶ SET /MEDIA/AUDIO/03.Balance=0
- ◀ pw /MEDIA/AUDIO/03.Balance=0

7.7.9. Analog Audio Output Level Settings by Steps

7.7.9.1. Setting the Volume (dB)

Command and Response *#analogaudio #volume*

- ▶ CALL /MEDIA/AUDIO/<audio_out>.stepVolumedB(<step>)
- ◀ m0 /MEDIA/AUDIO/<audio_out>.stepVolumedB

Parameters

Parameter	Parameter description	Values	Value description
<audio_out>	Audio output port number	01, 02, 03	
<step>	The output volume (attenuation) in dB		Volume is increased or decreased with the given value in dB.

Example

- ▶ CALL /MEDIA/AUDIO/03:stepVolumedB(-1)
- ◀ m0 /MEDIA/AUDIO/03:stepVolumedB

The volume is decreased with 1 dB, the current volume is -1.95 dB which means 77.84% in percent.

7.7.9.2. Setting the Volume (Percent)

Command and Response

- ▶ CALL /MEDIA/AUDIO/<audio_out>.stepVolumePercent(<step>)
- ◀ m0 /MEDIA/AUDIO/<audio_out>.stepVolumePercent

Parameters

Parameter	Parameter description	Values	Value description
<audio_out>	Audio output port number	01, 02, 03	
<step>	The output volume (attenuation) in percent		Volume is increased or decreased with the given value in percent.

Example

- ▶ CALL /MEDIA/AUDIO/03:stepVolumePercent(5)
- ◀ m0 /MEDIA/AUDIO/03:stepVolumePercent

The volume is increased with 5%, the current volume is -1.52 dB which means 82.84% in percent.

7.8. Ethernet Port Configuration

7.8.1. Set the DHCP State

ATTENTION! When you change a network property the new value is stored but the **applySettings** method must be called always to apply the new settings. When two or more network parameters are changed the **applySettings** method is enough to call once as a final step; it results the device to reboot.

Command and Response *#dhcp #network #ipaddress*

- ▶ SET /MANAGEMENT/NETWORK.DhcpEnabled=<dhcp_status>
- ◀ pw /MANAGEMENT/NETWORK.DhcpEnabled=<dhcp_status>

Parameters

If the <dhcp_status> parameter is **true**, the current IP address setting is DHCP, if the parameter is **false** the current IP address is static.

Example

- ▶ SET /MANAGEMENT/NETWORK.DhcpEnabled=true
- ◀ pw /MANAGEMENT/NETWORK.DhcpEnabled=true
- ▶ CALL /MANAGEMENT/NETWORK:applySettings(1)
- ◀ m0 /MANAGEMENT/NETWORK:applySettings

INFO: The **applySettings** method will save and apply the new value and results the device to reboot.

INFO: The current setting can be queried by using the [GET command](#).

7.8.2. Change the IP Address (Static)

Command and Response

- ▶ SET /MANAGEMENT/NETWORK.StaticIpAddress=<IP_address>
- ◀ pw /MANAGEMENT/NETWORK.StaticIpAddress=<IP_address>

Example

- ▶ SET /MANAGEMENT/NETWORK.StaticIpAddress=192.168.0.85
- ◀ pw /MANAGEMENT/NETWORK.StaticIpAddress=192.168.0.85
- ▶ CALL /MANAGEMENT/NETWORK:applySettings(1)
- ◀ m0 /MANAGEMENT/NETWORK:applySettings

INFO: The **applySettings** method will save and apply the new value and results the device to reboot.

INFO: The current setting can be queried by using the [GET command](#).

7.8.3. Change the Subnet Mask (Static)

Command and Response *#ipaddress*

- ▶ SET /MANAGEMENT/NETWORK.StaticNetworkMask=<netmask>
- ◀ pw /MANAGEMENT/NETWORK.StaticNetworkMask=<netmask>

Example

- ▶ SET /MANAGEMENT/NETWORK.StaticNetworkMask=255.255.255.0
- ◀ pw /MANAGEMENT/NETWORK.StaticNetworkMask=255.255.255.0
- ▶ CALL /MANAGEMENT/NETWORK:applySettings(1)
- ◀ m0 /MANAGEMENT/NETWORK:applySettings

INFO: The **applySettings** method will save and apply the new value and results the device to reboot.

INFO: The current setting can be queried by using the [GET command](#).

7.8.4. Change the Gateway Address (Static)

Command and Response

- ▶ SET /MANAGEMENT/NETWORK.StaticGatewayAddress=<gw_address>
- ◀ pw /MANAGEMENT/NETWORK.StaticGatewayAddress=<gw_address>

Example

- ▶ SET /MANAGEMENT/NETWORK.StaticGatewayAddress=192.168.0.5
- ◀ pw /MANAGEMENT/NETWORK.StaticGatewayAddress=192.168.0.5
- ▶ CALL /MANAGEMENT/NETWORK:applySettings(1)
- ◀ m0 /MANAGEMENT/NETWORK:applySettings

INFO: The **applySettings** method will save and apply the new value and results the extender to reboot.

INFO: The current setting can be queried by using the [GET command](#).

7.8.5. Apply Network Settings

Command and Response

- ▶ CALL /MANAGEMENT/NETWORK:ApplySettings()
- ◀ m0 /MANAGEMENT/NETWORK:ApplySettings

Example

- ▶ CALL /MANAGEMENT/NETWORK:ApplySettings()
- ◀ m0 /MANAGEMENT/NETWORK:ApplySettings

All network settings which are changed have been applied and network interface restarts.

7.9. Ethernet Message Sending

The device can be used for sending a message to a certain IP:port address. The three different commands allow controlling the connected (third-party) devices.

7.9.1. Sending a TCP Message (ASCII-format)

The command is for sending a command message in ASCII-format. This method allows escaping the control characters. For more information see the [Escaping](#) section.

Command and Response

- ▶ `CALL /MEDIA/ETHERNET:tcpMessage(<IP_address>:<port_no>=<message>)`
- ◀ `mO /MEDIA/ETHERNET:tcpMessage`

Example

- ▶ `CALL /MEDIA/ETHERNET:tcpMessage(192.168.0.103:6107=C00)`
- ◀ `mO /MEDIA/ETHERNET:tcpMessage`

The 'C00' message is sent to the indicated IP:port address.

Example with HEX codes

- ▶ `CALL /MEDIA/ETHERNET:tcpMessage(192.168.0.20:5555=C00\x0a\x0d)`
- ◀ `mO /MEDIA/ETHERNET:tcpMessage`

The 'C00' message with CrLf (Carriage return and Line feed) is sent to the indicated IP:port address. The \x sequence indicates the HEXA code; see more information in the [Using Hexadecimal Codes](#) section.

7.9.2. Sending a TCP Text (ASCII-format)

The command is for sending a text message in ASCII-format. This method **does not allow** escaping or inserting control characters.

Command and Response

- ▶ `CALL /MEDIA/ETHERNET:tcpText(<IP_address>:<port_no>=<text>)`
- ◀ `mO /MEDIA/ETHERNET:tcpText`

Example

- ▶ `CALL /MEDIA/ETHERNET:tcpText(192.168.0.103:6107=pwr_on)`
- ◀ `mO /MEDIA/ETHERNET:tcpText`

The 'pwr_on' text is sent to the indicated IP:port address.

7.9.3. Sending a TCP Binary Message (HEX-format)

The command is for sending a binary message in Hexadecimal format. This method **does not allow** escaping or inserting control characters.

Command and Response

- ▶ `CALL /MEDIA/ETHERNET:tcpBinary(<IP_address>:<port_no>=<HEX_message>)`
- ◀ `mO /MEDIA/ETHERNET:tcpBinary`

Example

- ▶ `CALL /MEDIA/ETHERNET:tcpBinary(192.168.0.103:6107=0100000061620000cdcc2c40)`
- ◀ `mO /MEDIA/ETHERNET:tcpBinary`

The '0100000061620000cdcc2c40' message is sent to the indicated IP:port address.

■ INFO: There is no need to insert a space or other separator character between the binary messages.

7.9.4. Sending a UDP Message (ASCII-format)

The command is for sending a UDP message in ASCII-format. This method allows escaping the control characters. For more information see the [Escaping](#) section.

Command and Response

- ▶ `CALL /MEDIA/ETHERNET:udpMessage(<IP_address>:<port_no>=<message>)`
- ◀ `mO /MEDIA/ETHERNET:udpMessage`

Example

- ▶ `CALL /MEDIA/ETHERNET:udpMessage(192.168.0.103:6107=C00)`
- ◀ `mO /MEDIA/ETHERNET:udpMessage`

The 'C00' message is sent to the indicated IP:port address.

Example with HEX codes

- ▶ `CALL /MEDIA/ETHERNET:udpMessage(192.168.0.20:9988=C00\x0a\x0d)`
- ◀ `mO /MEDIA/ETHERNET:udpMessage`

The 'C00' message with CrLf (Carriage return and Line feed) is sent to the indicated IP:port address. The \x sequence indicates the HEXA code; see more information in the [Using Hexadecimal Codes](#) section.

7.9.5. Sending a UDP Text (ASCII-format)

The command is for sending a text message in ASCII-format via UDP-protocol. This method **does not allow** escaping or inserting control characters.

Command and Response

- ▶ CALL:/MEDIA/ETHERNET:udpText(<IP_address>:<port_no>=<text>)
- ◀ mO:/MEDIA/ETHERNET:udpText

Example

- ▶ CALL /MEDIA/ETHERNET:udpText(192.168.0.20:9988=open)
- ◀ mO /MEDIA/ETHERNET:udpText

The 'open' text is sent to the indicated IP:port address.

7.9.6. Sending a UDP Binary Message (HEX-format)

The command is for sending a binary message in Hexadecimal format via UDP protocol. This method **does not allow** escaping or inserting control characters.

Command and Response

- ▶ CALL:/MEDIA/ETHERNET:udpBinary(<IP_address>:<port_no>=<HEX_message>)
- ◀ mO:/MEDIA/ETHERNET:udpBinary

Example

- ▶ CALL /MEDIA/ETHERNET:udpBinary(192.168.0.20:9988=433030)
- ◀ mO /MEDIA/ETHERNET:udpBinary

The '433030' message is sent to the indicated IP:port address.

■ INFO: There is no need to insert a space or other separator character between the binary messages.

7.10. RS-232 Port Configuration

INFO: Serial (local and link) port numbering can be found in the [Input/Output Port Numbering](#) section.

INFO: Only MMX4x2-HT200 model has TPS serial link.

7.10.1. Protocol Setting

Command and Response *#protocol #rs232 #rs-232 #serial*

- ▶ SET /MEDIA/UART/<serial_port>.ControlProtocol=<ctrl_protocol>
- ◀ pw /MEDIA/UART/<serial_port>.ControlProtocol=<ctrl_protocol>

Parameters

Parameter	Parameter description	Values	Value description
<serial_port>	Serial port number	P1, P2	
<ctrl_protocol>	RS-232 protocol mode	0	LW2
		1	LW3

Example

- ▶ SET /MEDIA/UART/P1.ControlProtocol=1
- ◀ pw /MEDIA/UART/P1.ControlProtocol=1

7.10.2. BAUD Rate Setting

Command and Response

- ▶ SET /MEDIA/UART/<serial_port>.Baudrate=<baudrate>
- ◀ pw /MEDIA/UART/<serial_port>.Baudrate=<baudrate>

Parameters

Parameter	Parameter description	Values	Value description
<serial_port>	Serial port number	P1, P2	
<baudrate>	Baud rate value	0	4800
		1	7200
		2	9600
		3	14400
		4	19200
		5	38400
		6	57600
		7	115200

Example

- ▶ SET /MEDIA/UART/P1.Baudrate=2

◀ pw /MEDIA/UART/P1.Baudrate=2

7.10.3. Databit Setting

Command and Response

- ▶ SET /MEDIA/UART/<serial_port>.DataBits=<databit>
- ◀ pw /MEDIA/UART/<serial_port>.DataBits=<databit>

Parameters

Parameter	Parameter description	Values	Value description
<serial_port>	Serial port number	P1, P2	
<databit>	Databit value	8, 9	

Example

- ▶ SET /MEDIA/UART/P1.DataBits=8
- ◀ pw /MEDIA/UART/P1.DataBits=8

7.10.4. Stopbits Setting

Command and Response

- ▶ SET /MEDIA/UART/<serial_port>.StopBits=<stopbit>
- ◀ pw /MEDIA/UART/<serial_port>.StopBits=<stopbit>

Parameters

Parameter	Parameter description	Values	Value description
<serial_port>	Serial port number	P1, P2	
<stopbit>	Stopbit value	0	1
		1	1.5
		2	2

Example

- ▶ SET /MEDIA/UART/P1.StopBits=0
- ◀ pw /MEDIA/UART/P1.StopBits=0

7.10.5. Parity Setting

Command and Response

- ▶ SET·/MEDIA/UART/<serial_port>.Parity=<parity>
- ◀ pw·/MEDIA/UART/<serial_port>.Parity=<parity>

Parameters

Parameter	Parameter description	Values	Value description
<serial_port>	Serial port number	P1, P2	
<parity>	Parity value	0	no parity
		1	odd
		2	even

Example

- ▶ SET /MEDIA/UART/P1.Parity=0
- ◀ pw /MEDIA/UART/P1.Parity=0

7.10.6. RS-232 Operation Mode

Command and Response *#commandinjection*

- ▶ SET·/MEDIA/UART/<serial_port>.Rs232Mode=<rs232_mode>
- ◀ pw·/MEDIA/UART/<serial_port>.Rs232Mode=<rs232_mode>

Parameters

Parameter	Parameter description	Values	Value description
<serial_port>	Serial port number	P1, P2	
<rs232_mode>	RS-232 operation mode	0	Pass-through
		1	Control
		2	Command Injection

Example

- ▶ SET /MEDIA/UART/P1.Rs232Mode=1
- ◀ pw /MEDIA/UART/P1.Rs232Mode=1

7.10.7. Enable Command Injection

Command and Response

- ▶ SET·/MEDIA/UART/<serial_port>.CommandInjectionEnable=<ci_enable>
- ◀ pw·/MEDIA/UART/<serial_port>.CommandInjectionEnable=<ci_enable>

Parameters

Parameter	Parameter description	Values	Value description
<serial_port>	Serial port number	P1, P2	
<ci_enable>	Command injection setting	true	Command Injection is enabled
		false	Command Injection is disabled

Example

- ▶ SET /MEDIA/UART/P1.CommandInjectionEnable=true
- ◀ pw /MEDIA/UART/P1.CommandInjectionEnable=true

ATTENTION! The Command injection status is stored in another read-only property: /MEDIA/UART/<serial_port>.CommandInjectionStatus.

7.11. RS-232 Message Sending

7.11.1. Sending a Message (ASCII-format) via RS-232

The command is for sending a command message in ASCII-format. This method **allows** escaping the control characters. For more information see the [Escaping](#) section.

Command and Response *#message*

- ▶ CALL /MEDIA/UART/P1:sendMessage(<message>)
- ◀ mO /MEDIA/UART/P1:sendMessage

Example

- ▶ CALL /MEDIA/UART/P1:sendMessage(PWR0)
- ◀ mO /MEDIA/UART/P1:sendMessage

The 'PWR0' message is sent out via the P1 serial port.

7.11.2. Sending a Text (ASCII-format) via RS-232

The command is for sending a command message in ASCII-format. This method **does not allow** escaping the control characters.

Command and Response

- ▶ CALL /MEDIA/UART/P1:sendText(<message>)
- ◀ mO /MEDIA/UART/P1:sendText

Example

- ▶ CALL /MEDIA/UART/P1:sendText(open)
- ◀ mO /MEDIA/UART/P1:sendText

The 'open' text is sent out via the P1 serial port.

7.11.3. Sending a Binary Message (HEX-format) via RS-232

The command is for sending a command message in Hexadecimal-format. This method **does not allow** escaping the control characters.

Command and Response

- ▶ CALL /MEDIA/UART/P1:sendBinaryMessage(<message>)
- ◀ mO /MEDIA/UART/P1:sendBinaryMessage

Example

- ▶ CALL /MEDIA/UART/P1:sendBinaryMessage(433030)
- ◀ mO /MEDIA/UART/P1:sendBinaryMessage

The '433030' message is sent out via the P1 serial port.

7.11.4. Using Hexadecimal Codes

Hexadecimal codes can be inserted in the ASCII message when using:

sendMessage command: CALL /MEDIA/UART/P1:sendMessage(C00\x0D)

tcpMessage command: CALL /MEDIA/ETHERNET:tcpMessage(C00\x0D)

udpMessage command: CALL /MEDIA/ETHERNET:udpMessage(C00\x0D)

- **C00:** the message.
- **\x:** indicates that the following is a hexadecimal code.
- **0D:** the hexadecimal code (Carriage Return).

7.12. RS-232 Message Recognizer

This tool is able to recognize the incoming RS-232 message. It stores the incoming serial data from the first bit, until the previously defined string (delimiter) or the elapsing timeout after the last bit. The last incoming serial string is saved in different formats (string, hex, and hash).

7.12.1. Enable the Recognizer

- ▶ SET-/MEDIA/UART/<serial_port>.RecognizerEnable=<recognizer_enable>
- ◀ pw-/MEDIA/UART/<serial_port>.RecognizerEnable=<recognizer_enable>

Parameters #recognizer #rs232recognizer #rs-232recognizer

Parameter	Parameter description	Values	Value description
<serial_port>	Serial port number	P1, P2	
<recognizer_enable>	Recognizer mode	true	Recognizer is enabled
		false	Recognizer is disabled

Example

- ▶ SET /MEDIA/UART/P1.RecognizerEnable=true
- ◀ pw /MEDIA/UART/P1.RecognizerEnable=true

7.12.2. Set the Delimiter Hex

When the delimiter hex string is detected in the incoming serial data, the device saves the RS-232 message data from the first bit, until the delimiter (or the data between the two delimiter).



- ▶ SET-/MEDIA/UART/RECOGNIZER.DelimiterHex=<delimiter>
- ◀ pw-/MEDIA/UART/RECOGNIZER.DelimiterHex=<delimiter>

Parameters

The <delimiter> parameter can be max. 8-character long (or 16 hex digit) in hex format.

Example

- ▶ SET /MEDIA/UART/RECOGNIZER.DelimiterHex=3a
- ◀ pw /MEDIA/UART/RECOGNIZER.DelimiterHex=3a

7.12.3. Set the Timeout

When the set time is elapsed after the last received message, the device saves the data. It can be applied, when there is no special or easily defined delimiter string in the incoming serial data, but there is a time gap between the messages.

- ▶ SET-/MEDIA/UART/RECOGNIZER.TimeOut=<timeout>
- ◀ pw-/MEDIA/UART/RECOGNIZER.TimeOut=<timeout>

Parameters

The <timeout> parameter sets the timeout value in milli seconds: 0 means the timeout is disabled, min. value is 10.

Example

- ▶ SET /MEDIA/UART/RECOGNIZER.TimeOut=20
- ◀ pw /MEDIA/UART/RECOGNIZER.TimeOut=20

7.12.4. Query the Last Recognized Message

The recognized data is stored in string, hex and hash formats. They are stored until the next incoming message or until the RECOGNIZER:clear() method is called.

TIPS AND TRICKS: When one of these properties are set as a condition in the Event Manager, and the same strings follow each other, the action **will execute once**.

7.12.4.1. Recognized Data in String Format

- ▶ GET-/MEDIA/UART/RECOGNIZER.Rx
- ◀ pr-/MEDIA/UART/RECOGNIZER.Rx=<recognized_string>

Parameters

The <recognized_string> parameter can be max. 12 byte-long recognized data string.

Example

- ▶ GET /MEDIA/UART/RECOGNIZER.Rx
- ◀ pr /MEDIA/UART/RECOGNIZER.Rx=Login:

7.12.4.2. Recognized Data in Hex Format

- ▶ GET-/MEDIA/UART/RECOGNIZER.RxHex
- ◀ pr-/MEDIA/UART/RECOGNIZER.RxHex=<recognized_hex>

Parameters

The <recognized_hex> parameter is the recognized data in hex format.

Example

- ▶ GET /MEDIA/UART/RECOGNIZER.RxHex
- ◀ pr /MEDIA/UART/RECOGNIZER.RxHex=FF1F4C6F67696E3A

7.12.4.3. Recognized Data Hash

- ▶ GET /MEDIA/UART/RECOGNIZER.Hash
- ◀ pr /MEDIA/UART/RECOGNIZER.Hash=<recognized_hash>

Parameters

The <recognized_hash> parameter is the fingerprint code, max. 32 bit-long recognized data hash.

Example

- ▶ GET /MEDIA/UART/RECOGNIZER.Hash
- ◀ pr /MEDIA/UART/RECOGNIZER.Hash=997A659E

7.12.5. Clear the Stored Last Recognized Serial Message

This method deletes all the stored received serial messages.

- ▶ CALL /MEDIA/UART/RECOGNIZER:clear()
- ◀ mO /MEDIA/UART/RECOGNIZER:clear

Example

- ▶ CALL /MEDIA/UART/RECOGNIZER:clear()
- ◀ mO /MEDIA/UART/RECOGNIZER:clear

7.12.6. Query the Last Recognized Active Message

The recognized data is stored in string, hex and hash format in a **temporary** storage. They are erased when the Active Timeout elapsed.

TIPS AND TRICKS: When these properties are set as a condition in the Event Manager, and the same strings follow each other, the action **will execute every occasion** if the active timeout set properly.

7.12.6.1. Recognized Data in String Format

- ▶ GET /MEDIA/UART/RECOGNIZER.ActiveRx
- ◀ pr /MEDIA/UART/RECOGNIZER.ActiveRx=<recognized_string>

Parameters

The <recognized_string> parameter is a max. 12 byte-long recognized data string.

Example

- ▶ GET /MEDIA/UART/RECOGNIZER.ActiveRx
- ◀ pr /MEDIA/UART/RECOGNIZER.ActiveRx=Login:

7.12.6.2. Recognized Data in Hex Format

- ▶ GET /MEDIA/UART/RECOGNIZER.ActiveRxHex
- ◀ pr /MEDIA/UART/RECOGNIZER.ActiveRxHex=<recognized_hex>

Parameters

The <recognized_hex> parameter is the recognized data in hex format.

Example

- ▶ GET /MEDIA/UART/RECOGNIZER.ActiveRxHex
- ◀ pr /MEDIA/UART/RECOGNIZER.ActiveRxHex= 4C6F67696E3A

7.12.6.3. Recognized Data Hash

- ▶ GET /MEDIA/UART/RECOGNIZER.ActiveHash
- ◀ pr /MEDIA/UART/RECOGNIZER.ActiveHash=<recognized_hash>

Parameters

The <recognized_hash> is the fingerprint code, max. 32 bit-long recognized data hash.

Example

- ▶ GET /MEDIA/UART/RECOGNIZER.ActiveHash
- ◀ pr /MEDIA/UART/RECOGNIZER.ActiveHash= 2D8A5E38

7.12.7. Set the Active Timeout

This property is responsible for erasing the temporary storage (ActiveRx, ActiveRxHex, ActiveHash) after the elapsing time. Default value is 50ms.

- ▶ SET /MEDIA/UART/RECOGNIZER.ActivePropertyTimeout=<a_timeout>
- ◀ pw /MEDIA/UART/RECOGNIZER.ActivePropertyTimeout=<a_timeout>

Parameters

The <a_timeout> parameter is the active timeout value (ms) between 0 and 255.

Example

- ▶ SET /MEDIA/UART/RECOGNIZER.ActivePropertyTimeout=255
- ◀ pw /MEDIA/UART/RECOGNIZER.ActivePropertyTimeout=255

7.13. CEC Command Sending

The device is able to send and receive Consumer Electronics Control (CEC) commands. This feature is for remote controlling the source or sink device. CEC is a bi-directional communication via HDMI cable.

INFO: The hidden first 2 bytes of the CEC command is static, it refers to the logical address of the sender and the addressee. When the port is input, it is always 04 (from TV to Playback device 1.), when the port is output, it is always 40 (from Playback device 1. to TV). Broadcast addressing is also possible (in this case it is 0F or 4F). #cec

7.13.1. Sending an OSD String

Sending the OSD string consists of two steps. First, set the **CEC.OsdString** property with the desired text, after that, call the **CEC.send(set_osd)** method.

Step 1 – Set the CEC.OsdString property

Command and Response

- ▶ SET /MEDIA/CEC/<port>.OsdString=<text>
- ◀ pw /MEDIA/CEC/<port>.OsdString=<text>

Parameters

Parameter	Parameter description	Values	Value description
<port>	Video input or video output port	I1-I4	Video inputs
		O1-O2	Video outputs
<text>	The desired OSD string		Letters (A-Z) and (a-z), hyphen (-), underscore (_), numbers (0-9), and dot (.). Max length: 14 characters.

Example

- ▶ SET /MEDIA/CEC/I2.OsdString=Lightware
- ◀ pw /MEDIA/CEC/I2.OsdString=Lightware

Step 2 – Call the CEC.send(set_osd) method

Command and Response

- ▶ CALL /MEDIA/CEC/<port>:send(set_osd)
- ◀ mO /MEDIA/CEC/I2:send

Parameters

The <port> parameters means the video input (I1-I4) or video output (O1-O2) port.

Example

- ▶ CALL /MEDIA/CEC/I2:send(set_osd)
- ◀ mO /MEDIA/CEC/I2:send

7.13.2. Sending a CEC Command in Text Format

Command and Response

- ▶ CALL /MEDIA/CEC/<port>:send(<command>)
- ◀ mO /MEDIA/CEC/<port>:send

Parameters

The <port> parameters means the video input (I1-I4) or video output (O1-O2) port. The followings are accepted as <command>:

image_view_on	standby	ok	back	up
down	left	right	root_menu	setup_menu
contents_menu	favorite_menu	media_top_menu	media_context_menu	number_0
number_1	number_2	number_3	number_4	number_5
number_6	number_7	number_8	number_9	dot
enter	clear	channel_up	channel_down	sound_select
input_select	display_info	power_legacy	page_up	page_down
volume_up	volume_down	mute_toggle	mute	unmute
play	stop	pause	record	rewind
fast_forward	eject	skip_forward	skip_backward	3d_mode
stop_record	pause_record	play_forward	play_reverse	select_next_media
select_media_1	select_media_2	select_media_3	select_media_4	select_media_5
power_toggle	power_on	power_off	stop_function	f1
f2	f3	f4		

Example

- ▶ CALL /MEDIA/CEC/I2:send(power_on)
- ◀ mO /MEDIA/CEC/I2:send

7.13.3. Send CEC Command in Hexadecimal Format

- ▶ CALL /MEDIA/CEC/<port>:sendHex(<hex_code>)
- ◀ mO /MEDIA/CEC/<port>:sendHex

Parameters

Parameter	Parameter description	Values	Value description
<port>	Video input or video output port	I1-I4	Video inputs
		O1-O2	Video outputs
<hex_code>	The desired CEC command		Max. 30 character (15 byte) in hexadecimal format.

Example

- ▶ CALL /MEDIA/CEC/I2:sendHex(8700E091)
- ◀ mO /MEDIA/CEC/I2:sendHex

7.13.4. Querying the Last Received CEC Message

- ▶ GET /MEDIA/CEC/<port>.LastReceivedMessage
- ◀ pr /MEDIA/CEC/<port>.LastReceivedMessage=<CEC_message>

Parameters

Parameter	Parameter description	Values	Value description
<port>	Video port	I1-I4 or O1-O2	
<CEC_message>	The last incoming CEC message from the connected device.		

Example

- ▶ GET /MEDIA/CEC/I2.LastReceivedMessage
- ◀ pr /MEDIA/CEC/I2.LastReceivedMessage=give_power_status

TIPS AND TRICKS: This property can be a condition in the [Event Manager](#). When the connected device sends status information via CEC, it could be a trigger for an action.

7.14. Infrared Port Configuration

INFO: Infrared (local and link) port numbering can be found in the [Input/Output Port Numbering](#) section.

INFO: Only MMX4x2-HT200 model has TPS IR link.

7.14.1. Enable Command Injection Mode

Command and Response *#infra #infrared*

- ▶ SET /MEDIA/IR/<ir_port>.CommandInjectionEnable=<ci_status>
- ◀ pw /MEDIA/IR/<ir_port>.CommandInjectionEnable=<ci_status>

Parameters

Parameter	Parameter description	Values	Value description
<ir_port>	IR port number	S1, S2	IR inputs
		D1, D2	IR outputs
<ci_status>	Recognizer mode	true	Command injection mode is enabled
		false	Command injection mode is disabled

Example

- ▶ SET /MEDIA/IR/S1.CommandInjectionEnable=true
- ◀ pw /MEDIA/IR/S1.CommandInjectionEnable=true

7.14.2. Change Command Injection Port Number

Command and Response

- ▶ SET /MEDIA/IR/<ir_port>.CommandInjectionPort=<port_no>
- ◀ pw /MEDIA/IR/<ir_port>.CommandInjectionPort=<port_no>

Parameters

Parameter	Parameter description	Values	Value description
<ir_port>	IR port number	S1, S2	IR inputs
		D1, D2	IR outputs
<port_no>	TCP port number for Command injection mode		

Example

- ▶ SET /MEDIA/IR/S1.CommandInjectionPort=9001
- ◀ pw /MEDIA/IR/S1.CommandInjectionPort=9001

7.14.3. Enable/Disable Output Signal Modulation

Command and Response

- ▶ SET /MEDIA/IR/<ir_out>.EnableModulation=<modulation>
- ◀ pw /MEDIA/IR/<ir_out>.EnableModulation=<modulation>

Parameters

Parameter	Parameter description	Values	Value description
<ir_out>	IR port number	D1, D2	IR outputs
<modulation>	IR signal modulation state	true	Signal modulation is enabled
		false	Signal modulation is disabled

Example

- ▶ SET /MEDIA/IR/D1.EnableModulation=false
- ◀ pw /MEDIA/IR/D1.EnableModulation=false

Signal modulation is turned off on IR output (D1).

INFO: The default setting value is **true** (enabled).

7.16. GPIO Port Configuration

DIFFERENCE: This section refers to the MMX4x2-HDMI20-USB-L model only. *#new*

7.16.1. Querying the Direction of a GPIO Pin

Command and Response *#gpio*

- ▶ GET·/MEDIA/GPIO/<port>.Direction
- ◀ pw·/MEDIA/GPIO/<port>.Direction(<dir>)

Parameters

Parameter	Parameter description	Value	Value description
<dir>	The direction of the GPIO pin.	I	input
		O	output

Example

- ▶ GET /MEDIA/GPIO/P1.Direction
- ◀ pw /MEDIA/GPIO/P1.Direction=I

7.16.2. Setting the Direction of a GPIO Pin

Command and Response

- ▶ SET·/MEDIA/GPIO/<port>.Direction(<dir>)
- ◀ pw·/MEDIA/GPIO/<port>.Direction(<dir>)

Parameters

See the previous section.

Example

- ▶ SET /MEDIA/GPIO/P1.Direction=I
- ◀ pw /MEDIA/GPIO/P1.Direction=I

7.16.3. Querying the Output Level of a GPIO Pin

Command and Response

- ▶ GET·/MEDIA/GPIO/<port>.Output
- ◀ pw·/MEDIA/GPIO/<port>.Output(<value>)

Parameters

Parameter	Parameter description	Value	Value description
<value>	The output value of the GPIO pin.	H	high level
		L	low level

Example

- ▶ GET /MEDIA/GPIO/P1.Direction
- ◀ pw /MEDIA/GPIO/P1.Direction=I

7.16.4. Setting the Output Level of a GPIO Pin

Command and Response

- ▶ SET·/MEDIA/GPIO/<port>.Output(<value>)
- ◀ pw·/MEDIA/GPIO/<port>.Output(<value>)

Parameters

See the previous section.

Example

- ▶ SET /MEDIA/GPIO/P1.Direction=I
- ◀ pw /MEDIA/GPIO/P1.Direction=I

7.16.5. Toggling the Level of a GPIO Pin

The output level can be changed from high to low and low to high by the command below.

Command and Response

- ▶ CALL·/MEDIA/GPIO/<port>:toggle()
- ◀ m0·/MEDIA/GPIO/<port>:toggle

Example

- ▶ CALL /MEDIA/GPIO/P1:toggle()
- ◀ m0 /MEDIA/GPIO/P1:toggle

7.17. USB 2.0 Switch Configuration

7.17.1. Setting the Active USB Host

Below command is for selecting a USB B-type port (host computer) that will be connected to the USB peripherals (USB A-type ports).

Command and Response *#usb #new*

- ▶ SET·/MEDIA/USB/USBSWITCH.HostSelect=<host_nr>
- ◀ pw·/MEDIA/USB/USBSWITCH.HostSelect=<host_nr>

Parameters

Parameter	Parameter description	Value	Value description
<host_nr>	USB B-type port number.	1-4	port number
		0	off state

Example

- ▶ SET /MEDIA/USB/USBSWITCH.HostSelect=2
- ◀ pw /MEDIA/USB/USBSWITCH.HostSelect=2

7.17.2. Power Switch Delay

After switching between the hosts, certain connected USB peripherals need to be reset to operate properly. Enable the power switch delay function, then the 5V power of all the devices is off for 2 seconds. This forces the devices to restart, thus, you do not have to physically unplug/re-plug the connected USB device.

Command and Response

- ▶ SET·/MEDIA/USB/USBSWITCH.DelayedSwitch=<delay_state>
- ◀ pw·/MEDIA/USB/USBSWITCH.DelayedSwitch=<delay_state>

Parameters

Parameter	Parameter description	Value	Value description
<delay_state>	2 sec power-cut towards the devices if host is changed	true	power cut-off is active
		false	power cut-off is inactive

Example

- ▶ SET /MEDIA/USB/USBSWITCH.DelayedSwitch=2
- ◀ pw /MEDIA/USB/USBSWITCH.DelayedSwitch=2

7.17.3. Querying the Host Presence

The USB B-type ports can be queried to check if there is a connected USB host device to a port. The 5V signal presence of a connected USB host device can be queried as follows:

Command and Response

- ▶ GET·/MEDIA/USB/USBSWITCH.<host_pc>
- ◀ pr·/MEDIA/USB/USBSWITCH.<host_pc>=<status>

Parameters

Parameter	Parameter description	Value	Value description
<host_pc>	The ID of the host PC	Host5vSensePc1	
		Host5vSensePc2	
		Host5vSensePc3	
		Host5vSensePc4	
<status>	5V signal presence of the connected host	true	5V is detected
		false	5V is not detected

Example

- ▶ GET /MEDIA/USB/USBSWITCH.Host5vSensePc1
- ◀ pr /MEDIA/USB/USBSWITCH.Host5vSensePc1=true

7.17.4. Setting the 5V Sending to the USB Peripherals

The 5V power towards the USB A-type ports can be enabled or disabled as follows:

Command and Response

- ▶ SET·/MEDIA/USB/USBSWITCH.<device_pwr>
- ◀ pw·/MEDIA/USB/USBSWITCH.<device_pwr>=<status>

Parameters

Parameter	Parameter description	Value	Value description
<device_pwr>	5V output parameter of the USB A-type port	Device5vEnable1	
		Device5vEnable2	
		Device5vEnable3	
		Device5vEnable4	
<status>	5V power towards the USB peripheral	true	5V is sent
		false	5V is not sent

Example

- ▶ SET /MEDIA/USB/USBSWITCH.Device5vEnable1=false
- ◀ pw /MEDIA/USB/USBSWITCH.Device5vEnable1=false

7.17.5. Querying the 5V Overcurrent State of a USB Peripheral

When a connected USB peripheral needs more current via the USB A-type port than allowed (e.g. because of a malfunction or a hardware-error), certain integrated circuits may get damaged. At this time, a special property is changed in the LW3 tree to avoid such situations:

■ INFO: The limit of the overcurrent is 1A.

Command and Response

- ▶ GET /MEDIA/USB/USBSWITCH.<device_cur>
- ◀ pr /MEDIA/USB/USBSWITCH.<device_cur>=<status>

Parameters

Parameter	Parameter description	Value	Value description
<device_cur>	The overcurrent property of the USB port	Device5vOverCurrent1	
		Device5vOverCurrent2	
		Device5vOverCurrent3	
		Device5vOverCurrent4	
<status>	The overcurrent state of the USB peripheral	true	Overcurrent is detected
		false	Overcurrent is not detected

Example

- ▶ GET /MEDIA/USB/USBSWITCH.Device5vOverCurrent2
- ◀ pr /MEDIA/USB/USBSWITCH.Device5vOverCurrent2=false

7.18. EDID Management

7.18.1. Query the Emulated EDIDs

Command and Response *#edid*

- ▶ GET /EDID.EdidStatus
- ◀ pr /EDID.EdidStatus=<source>:E1;<source>:E2;<source>:E3;<source>:E4

Parameters

Parameter	Parameter description	Values	Value description
<source>	Source EDID memory place	F1-F120 U1-U14 D1-D2	Factory EDIDs User EDIDs Dynamic EDIDs

Example

- ▶ GET /EDID.EdidStatus
- ◀ pr /EDID.EdidStatus=F89:E1;D1:E2;D1:E3;D1:E4

Emulated EDID memory for input port is listed with the EDID number that is currently emulated on the input.

7.18.2. Query the Validity of a Dynamic EDID

Command and Response

- ▶ GET /EDID/D/D1.Validity
- ◀ pr /EDID/D/D1.Validity=<validity>

Parameters

If the <validity> parameter is **true**, the EDID is valid. If the parameter is **false**, the EDID is invalid.

Example

- ▶ GET /EDID/D/D1.Validity
- ◀ pr /EDID/D/D1.Validity=true

The 'Validity' property is true, valid EDID is stored in D1 memory place.

7.18.3. Query the Preferred Resolution of a User EDID

Command and Response

- ▶ GET /EDID/U/<user_edid>.PreferredResolution
- ◀ pr /EDID/U/<user_edid>.PreferredResolution=<preferred_resolution>

Example

- ▶ GET /EDID/U/U2.PreferredResolution
- ◀ pr /EDID/U/U2.PreferredResolution=1920x1080p60.00Hz

INFO: Use the **Manufacturer** and **MonitorName** properties to query further information.

7.18.4. Emulating an EDID to an Input Port

Command and Response

- ▶ CALL /EDID:switch(<source>:<destination>)
- ◀ mO /EDID:switch

Parameters

Parameter	Parameter description	Values	Value description
<source>	Source EDID memory place	F1-F120 U1-U14 D1-D2	Factory EDIDs User EDIDs Dynamic EDIDs
<destination>	The emulated EDID memory of the desired input port	U1-U14	User EDIDs

Example

- ▶ CALL /EDID:switch(F49:E2)
- ◀ mO /EDID:switch

7.18.5. Emulating an EDID to All Input Ports

Command and Response

- ▶ CALL /EDID:switchAll(<source>)
- ◀ mO /EDID:switchAll

Parameters

Parameter	Parameter description	Values	Value description
<source>	Source EDID memory place	F1-F120 U1-U14 D1-D2	Factory EDIDs User EDIDs Dynamic EDIDs

Example

- ▶ CALL /EDID:switchAll(F47)
- ◀ mO /EDID:switchAll

7.18.6. Copy an EDID to User Memory

Command and Response

- ▶ CALL·/EDID:copy(<source>:<destination>)
- ◀ mO·/EDID:copy

Parameters

Parameter	Parameter description	Values	Value description
<source>	Source EDID memory place	F1-F120	Factory EDIDs
		U1-U14	User EDIDs
		D1-D2	Dynamic EDIDs
<destination>	The emulated EDID memory of the desired input port	U1-U14	User EDIDs

Example

- ▶ CALL /EDID:copy(F1:U2)
- ◀ mO /EDID:copy

7.18.7. Deleting an EDID from User Memory

Command and Response

- ▶ CALL·/EDID:delete(<user_edid>)
- ◀ mO·/EDID:delete

Parameters

Parameter	Parameter description	Values	Value description
<user_edid>	The emulated EDID memory of the desired input port.	U1-U14	User EDIDs

Example

- ▶ CALL /EDID:delete(U2)
- ◀ mO /EDID:delete

7.18.8. Resetting the Emulated EDIDs

Command and Response

- ▶ CALL·/EDID:reset()
- ◀ mO·/EDID:reset

Parameters

Parameter	Parameter description	Values	Value description
<user_edid>	The emulated EDID memory of the desired input port.	U1-U14	User EDIDs

Example

- ▶ CALL /EDID:reset()
- ◀ mO /EDID:reset

Calling this method switches all emulated EDIDs to factory default one. See the table in the [Factory EDID List](#) section.

7.19. LW3 Commands - Quick Summary

System Commands

Setting the Device Label

- ▶ SET·/MANAGEMENT/UID/DeviceLabel=<custom_name>

Resetting the Device

- ▶ CALL·/SYS:reset()

Restore the Factory Default Settings

- ▶ CALL·/SYS:factoryDefaults()

Querying the Firmware Version

- ▶ GET·/SYS/MB.FirmwareVersion

Control Lock

- ▶ SET·/MANAGEMENT/UI.ControlLock=<lock_status>

Identify the Device

- ▶ CALL·/MANAGEMENT/UI.identifyMe()

Video Port Settings

Querying the Status of the Input Ports

- ▶ GET·/MEDIA/VIDEO/XP.SourcePortStatus

Querying the Status of the Output Ports

- ▶ GET·/MEDIA/VIDEO/XP.DestinationPortStatus

Querying the Video Crosspoint Setting

- ▶ GET·/MEDIA/VIDEO/XP.DestinationConnectionList

Switching Video Input

- ▶ CALL·/MEDIA/VIDEO/XP:switch(<in>:<out>)

Querying the Video Autoselect Settings

- ▶ GET·/MEDIA/VIDEO/XP.DestinationPortAutoselect

Changing the Autoselect Mode

- ▶ CALL·/MEDIA/VIDEO/XP:setDestinationPortAutoselect(<out>:<state><mode>)

Querying the Input Port Priority

- ▶ GET·/MEDIA/VIDEO/XP.PortPriorityList

Changing the Input Port Priority

- ▶ CALL·/MEDIA/VIDEO/XP:setAutoselectionPriority(<in>(<out>):<prio>)

Mute an Input Port

- ▶ CALL·/MEDIA/VIDEO/XP:muteSource(<in>)

Unmute an Input Port

- ▶ CALL·/MEDIA/VIDEO/XP:unmuteSource(<in>)

Lock an Input Port

- ▶ CALL·/MEDIA/VIDEO/XP:lockSource(<in>)

Unlock an Input Port

- ▶ CALL·/MEDIA/VIDEO/XP:unlockSource(<in>)

Mute an Output Port

- ▶ CALL·/MEDIA/VIDEO/XP:muteDestination(<out>)

Unmute an Output Port

- ▶ CALL·/MEDIA/VIDEO/XP:unmuteDestination(<out>)

Lock an Output Port

- ▶ CALL·/MEDIA/VIDEO/XP:lockDestination(<out>)

Unlock an Output Port

- ▶ CALL·/MEDIA/VIDEO/XP:unlockDestination(<out>)

HDCP Setting (Input Port)

- ▶ SET·/MEDIA/VIDEO/<in>.HdcpEnable=<hdcp_status>

HDCP Setting (Output Port)

- ▶ SET·/MEDIA/VIDEO/<out>.HdcpModeSetting=<hdcp_mode>

Test Pattern Generator

Test Pattern Generator Mode Setting

- ▶ SET·/MEDIA/VIDEO/<out>.TpgMode=<tpg_mode>

The Clock Frequency of the Test Pattern

- ▶ SET·/MEDIA/VIDEO/<out>.TpgClockSource=<tpg_clock>

Test Pattern

- ▶ SET·/MEDIA/VIDEO/<out>.TpgPattern=<pattern>

HDMI Mode Settings (Output Port)

- ▶ SET·/MEDIA/VIDEO/<out>.HdmiModeSetting=<hdmi_mode>

Querying the Recent TPS Mode

- ▶ GET·/REMOTE/<tps_port>.tpsMode

TPS Mode Settings

- ▶ SET·/REMOTE/<tps_port>.tpsModeSetting=<tps_mode>

Audio Port Settings for Firmware v1.2.0**Querying the Status of Source Port**

- ▶ GET·/MEDIA/AUDIO/XP.SourcePortStatus

Querying the Status of Destination Port

- ▶ GET·/MEDIA/AUDIO/XP.DestinationPortStatus

Querying the Audio Crosspoint State

- ▶ GET·/MEDIA/AUDIO/XP.DestinationConnectionList

Switching Audio Input

- ▶ CALL·/MEDIA/AUDIO/XP:switch(<audio_in>:<audio_out>)

Querying the Audio Autoselect Settings

- ▶ GET·/MEDIA/AUDIO/XP.DestinationPortAutoselect

Changing the Autoselect Mode

- ▶ CALL·/MEDIA/AUDIO/XP:setDestinationPortAutoselect(<out>:<state><mode>)

Querying the Input Port Priority

- ▶ GET·/MEDIA/AUDIO/XP.PortPriorityList

Changing the Input Port Priority

- ▶ CALL·/MEDIA/AUDIO/XP:setAutoselectionPriority(<in>(<out>):<prio>)

Mute an Audio Input

- ▶ CALL·/MEDIA/AUDIO/XP:muteSource(<audio_in>)

Unmute an Audio Input

- ▶ CALL·/MEDIA/AUDIO/XP:unmuteSource(<audio_in>)

Lock an Input Port

- ▶ CALL·/MEDIA/AUDIO/XP:lockSource(<audio_in>)

Unlock an Input Port

- ▶ CALL·/MEDIA/AUDIO/XP:unlockSource(<audio_in>)

Mute an Audio Output Port

- ▶ CALL·/MEDIA/AUDIO/XP:muteDestination(<audio_out>)

Unmute an Audio Output Port

- ▶ CALL·/MEDIA/AUDIO/XP:unmuteDestination(<audio_out>)

Lock an Audio Output Port

- ▶ CALL·/MEDIA/AUDIO/XP:lockDestination(<audio_out>)

Unlock an Audio Output Port

- ▶ CALL·/MEDIA/AUDIO/XP:unlockDestination(<audio_out>)

Analog Audio Input Gain Setting

- ▶ SET·/MEDIA/AUDIO/A3.Gain=<level>

Analog Audio Output Level Settings by Exact Values**Setting the Volume (dB)**

- ▶ SET·/MEDIA/AUDIO/O3.VolumedB=<level>

Setting the Volume (Percent)

- ▶ SET·/MEDIA/AUDIO/O3.VolumePercent=<percent>

Setting the Balance

- ▶ SET·/MEDIA/AUDIO/O3.Balance=<level>

Analog Audio Output Level Settings by Steps**Volume Setting (dB)**

- ▶ CALL·/MEDIA/AUDIO/O3:stepVolumedB=<step>

Volume Setting in Percent

- ▶ CALL·/MEDIA/AUDIO/O3:stepVolumePercent=<step>

Audio Port Settings for Firmware v1.1.0**Set Audio Source of HDMI Output 1**

- ▶ SET·/SYS/MB/LEGACYAUDIOXP.EmbedAudioInputToHdmiOut1=<embed_audio>

Set Audio Source of HDMI Output 2

- ▶ SET·/SYS/MB/LEGACYAUDIOXP.EmbedAudioInputToHdmiOut2=<embed_audio>

Set Audio Source of Analog Audio Output

- ▶ SET·/SYS/MB/LEGACYAUDIOXP.EnableAnalogPassthrough=<passthrough_status>

Mute/Unmute Analog Audio Input

- ▶ SET·/MEDIA/AUDIO/<audio_in>.Mute=<mute_status>

Mute/Unmute Analog Audio Output

- ▶ SET·/MEDIA/AUDIO/<audio_out>.Mute=<mute_status>

Analog Audio Input Level Settings by Exact Values**Setting the Volume (dB)**

- ▶ SET·/MEDIA/AUDIO/<audio_in>.VolumedB=<level>

Setting the Volume (Percent)

- ▶ SET·/MEDIA/AUDIO/<audio_in>.VolumePercent=<percent>

Setting the Balance

- ▶ SET·/MEDIA/AUDIO/<audio_in>.Balance=<level>

Setting the Gain

- ▶ SET·/MEDIA/AUDIO/<audio_in>.Gain=<level>

Analog Audio Input Level Settings by Steps**Setting the Volume (dB)**

- ▶ CALL·/MEDIA/AUDIO/<audio_in>:stepVolumedB(<step>)

Setting the Volume (in Percent)

- ▶ CALL·/MEDIA/AUDIO/<audio_in>:stepVolumePercent(<step>)

Setting the Balance

- ▶ CALL·/MEDIA/AUDIO/<audio_in>:stepBalance(<step>)

Analog Audio Output Level Settings**Setting the Volume (dB)**

- ▶ SET·/MEDIA/AUDIO/<audio_out>.VolumedB=<level>

Setting the Volume (Percent)

- ▶ SET·/MEDIA/AUDIO/<audio_out>.VolumePercent=<percent>

Setting the Balance

- ▶ SET·/MEDIA/AUDIO/<audio_out>.Balance=<level>

Analog Audio Output Level Settings by Steps**Setting the Volume (dB)**

- ▶ CALL·/MEDIA/AUDIO/<audio_out>:stepVolumedB(<step>)

Setting the Volume (Percent)

- ▶ CALL·/MEDIA/AUDIO/<audio_out>:stepVolumePercent(<step>)

Ethernet Port Configuration**Set the DHCP State**

- ▶ SET·/MANAGEMENT/NETWORK.DhcpEnabled=<dhcp_status>

Change the IP Address (Static)

- ▶ SET·/MANAGEMENT/NETWORK.StaticIpAddress=<IP_address>

Change the Subnet Mask (Static)

- ▶ SET·/MANAGEMENT/NETWORK.StaticNetworkMask=<netmask>

Change the Gateway Address (Static)

- ▶ SET·/MANAGEMENT/NETWORK.StaticGatewayAddress=<gw_address>

Apply Network Settings

- ▶ CALL·/MANAGEMENT/NETWORK:ApplySettings()

Ethernet Message Sending**Sending a TCP Message (ASCII-format)**

- ▶ CALL·/MEDIA/ETHERNET:tcpMessage(<IP_address>:<port_no>=<message>)

Sending a TCP Text (ASCII-format)

- ▶ CALL·/MEDIA/ETHERNET:tcpText(<IP_address>:<port_no>=<text>)

Sending a TCP Binary Message (HEX-format)

- ▶ CALL·/MEDIA/ETHERNET:tcpBinary(<IP_address>:<port_no>=<HEX_message>)

Sending a UDP Message (ASCII-format)

- ▶ CALL·/MEDIA/ETHERNET:udpMessage(<IP_address>:<port_no>=<message>)

Sending a UDP Text (ASCII-format)

- ▶ CALL·/MEDIA/ETHERNET:udpText(<IP_address>:<port_no>=<text>)

Sending a UDP Binary Message (HEX-format)

- ▶ CALL·/MEDIA/ETHERNET:udpBinary(<IP_address>:<port_no>=<HEX_message>)

RS-232 Port Configuration**Protocol Setting**

- ▶ SET·/MEDIA/UART/<serial_port>.ControlProtocol=<ctrl_protocol>

BAUD Rate Setting

- ▶ SET·/MEDIA/UART/<serial_port>.Baudrate=<baudrate>

Databit Setting

- ▶ SET·/MEDIA/UART/<serial_port>.DataBits=<databit>

Stopbits Setting

- ▶ SET·/MEDIA/UART/<serial_port>.StopBits=<stopbit>

Parity Setting

- ▶ SET·/MEDIA/UART/<serial_port>.Parity=<parity>

RS-232 Operation Mode

- ▶ SET·/MEDIA/UART/<serial_port>.Rs232Mode=<rs232_mode>

Enable Command Injection

- ▶ SET·/MEDIA/UART/<serial_port>.CommandInjectionEnable=<ci_enable>

RS-232 Message Sending**Sending a Message (ASCII-format) via RS-232**

- ▶ CALL·/MEDIA/UART/P1:sendMessage(<message>)

Sending a Text (ASCII-format) via RS-232

- ▶ CALL·/MEDIA/UART/P1:sendText(<message>)

Sending a Binary Message (HEX-format) via RS-232

- ▶ CALL·/MEDIA/UART/P1:sendBinaryMessage(<message>)

Using Hexadecimal Codes**RS-232 Message Recognizer****Enable the Recognizer**

- ▶ SET·/MEDIA/UART/<serial_port>.RecognizerEnable=<recognizer_enable>

Set the Delimiter Hex

- ▶ SET·/MEDIA/UART/RECOGNIZER.DelimiterHex=<delimiter>

Set the Timeout

- ▶ SET·/MEDIA/UART/RECOGNIZER.TimeOut=<timeout>

Query the Last Recognized Message**Recognized Data in String Format**

- ▶ GET·/MEDIA/UART/RECOGNIZER.Rx

Recognized Data in Hex Format

- ▶ GET·/MEDIA/UART/RECOGNIZER.RxHex

Recognized Data Hash

- ▶ GET·/MEDIA/UART/RECOGNIZER.Hash

Clear the Stored Last Recognized Serial Message

- ▶ CALL·/MEDIA/UART/RECOGNIZER:clear()

Query the Last Recognized Active Message**Recognized Data in String Format**

- ▶ GET·/MEDIA/UART/RECOGNIZER.ActiveRx

Recognized Data in Hex Format

- ▶ GET·/MEDIA/UART/RECOGNIZER.ActiveRxHex

Recognized Data Hash

- ▶ GET·/MEDIA/UART/RECOGNIZER.ActiveHash

Set the Active Timeout

- ▶ SET·/MEDIA/UART/RECOGNIZER.ActivePropertyTimeout=<a_timeout>

CEC Command Sending**Sending an OSD String**

- ▶ SET·/MEDIA/CEC/<port>.OsdString=<text>
- ▶ CALL·/MEDIA/CEC/<port>:send(set_osd)

Sending a CEC Command in Text Format

- ▶ CALL·/MEDIA/CEC/<port>:send(<command>)

Send CEC Command in Hexadecimal Format

- ▶ CALL·/MEDIA/CEC/<port>:sendHex(<hex_code>)

Querying the Last Received CEC Message

- ▶ GET /MEDIA/CEC/<port>.LastReceivedMessage

Infrared Port Configuration**Enable Command Injection Mode**

- ▶ SET·/MEDIA/IR/<ir_port>.CommandInjectionEnable=<ci_status>

Change Command Injection Port Number

- ▶ SET·/MEDIA/IR/<ir_port>.CommandInjectionPort=<port_no>

Enable/Disable Output Signal Modulation

- ▶ SET·/MEDIA/IR/<ir_out>.EnableModulation=<modulation>

Infrared Message Sending**Sending Pronto Hex Codes in Little-endian Format via IR Port**

- ▶ CALL·/MEDIA/IR/D1:sendProntoHex(<hex_code>)

Sending Pronto Hex Codes in Big-endian Format via IR Port

- ▶ CALL·/MEDIA/IR/D1:sendProntoHexBigEndian(<hex_code>)

GPIO Port Configuration**Querying the Direction of a GPIO Pin**

- ▶ GET·/MEDIA/GPIO/<port>.Direction

Setting the Direction of a GPIO Pin

- ▶ SET·/MEDIA/GPIO/<port>.Direction(<dir>)

Querying the Output Level of a GPIO Pin

- ▶ GET·/MEDIA/GPIO/<port>.Output

Setting the Output Level of a GPIO Pin

- ▶ SET·/MEDIA/GPIO/<port>.Output(<value>)

Toggling the Level of a GPIO Pin

- ▶ CALL·/MEDIA/GPIO/<port>:toggle()

USB 2.0 Switch Configuration**Setting the Active USB Host**

- ▶ SET·/MEDIA/USB/USBSWITCH.HostSelect=<host_nr>

Power Switch Delay

- ▶ SET:/MEDIA/USB/USBSWITCH.DelayedSwitch=<delay_state>

Querying the Host Presence

- ▶ GET:/MEDIA/USB/USBSWITCH.<host_pc>

Setting the 5V Sending to the USB Peripherals

- ▶ SET:/MEDIA/USB/USBSWITCH.<device_pwr>

Querying the 5V Overcurrent State of a USB Peripheral

- ▶ GET:/MEDIA/USB/USBSWITCH.<device_cur>

EDID Management

Query the Emulated EDIDs

- ▶ GET:/EDID.EdidStatus

Query the Validity of a Dynamic EDID

- ▶ GET:/EDID/D/D1.Validity

Query the Preferred Resolution of a User EDID

- ▶ GET:/EDID/U/<user_edid>.PreferredResolution

Emulating an EDID to an Input Port

- ▶ CALL:/EDID:switch(<source>:<destination>)

Emulating an EDID to All Input Ports

- ▶ CALL:/EDID:switchAll(<source>)

Copy an EDID to User Memory

- ▶ CALL:/EDID:copy(<source>:<destination>)

Deleting an EDID from User Memory

- ▶ CALL:/EDID:delete(<user_edid>)

Resetting the Emulated EDIDs

- ▶ CALL:/EDID:reset()

8

Firmware Upgrade

This chapter is meant to help customers perform firmware upgrades on our products by giving a few tips on how to start and by explaining the features of the Lightware Device Updater v2 (LDU2) software. To get the latest software and firmware pack can be downloaded from www.lightware.com.

- ▶ INTRODUCTION
- ▶ PREPARATION
- ▶ RUNNING THE SOFTWARE
- ▶ THE UPGRADING STEPS
- ▶ IF THE UPGRADE IS NOT SUCCESSFUL

ATTENTION! While the firmware is being upgraded, the normal operation mode is suspended as the transmitter is switched to bootload mode. Signal processing is not performed. Do not interrupt the firmware upgrade. If any problem occurs, reboot the device and restart the process.

8.1. Introduction

Lightware Device Updater v2 (LDU2) software is the second generation of the LFP-based (Lightware Firmware Package) firmware upgrade process.

DIFFERENCE: The software can be used for uploading the packages with LFP2 extension only. LDU2 is not suitable for using LFP files, please use the LDU software for that firmware upgrade.



8.2. Preparation

Most Lightware devices can be controlled over more interfaces (e.g. Ethernet, USB, RS-232). But the firmware can be upgraded usually over one dedicated interface, which is the Ethernet in most cases.

If you want to upgrade the firmware of one or more devices you need the following:

- LFP2 file,
- LDU2 software installed on your PC or Mac.

Both can be downloaded from www.lightware.com/downloads.

Optionally, you can download the **release notes** file in HTML format.

8.2.1. About the Firmware Package (LFP2 File)

All the necessary tools and binary files are packed into the LFP2 package file. You need only this file to do the upgrade on your device.

- This allows the use of the same LFP2 package for different devices.
- The package contains all the necessary components, binary, and other files.
- The release notes is included in the LFP2 file which is displayed in the window where you select the firmware package file in LDU2.

8.2.2. LDU2 Installation

ATTENTION! Minimum system requirement: 2 GB RAM.

INFO: The Windows and the Mac application has the same look and functionality.

Download the software from www.lightware.com/downloads.

Installation in case of Windows OS

Run the installer. If the User Account Control displays a pop-up message click **Yes**.

Installation Modes

Normal install	Snapshot install
Available for Windows and MacOS	Available for Windows
The installer can update only this instance	Cannot be updated
One updateable instance may exist for all users	Many different versions can be installed for all users

ATTENTION! Using the default Normal install is highly recommended.

INFO: If you have a previously installed version you will be prompted to remove the old version before installing the new one.

Installation in case of macOS X

Mount the DMG file with double clicking on it and drag the LDU2 icon over the Applications icon to copy the program into the Applications folder. If you want to copy LDU2 into another location just drag the icon over the desired folder.

INFO: This type of installer is equal with the **Normal install** of Windows.

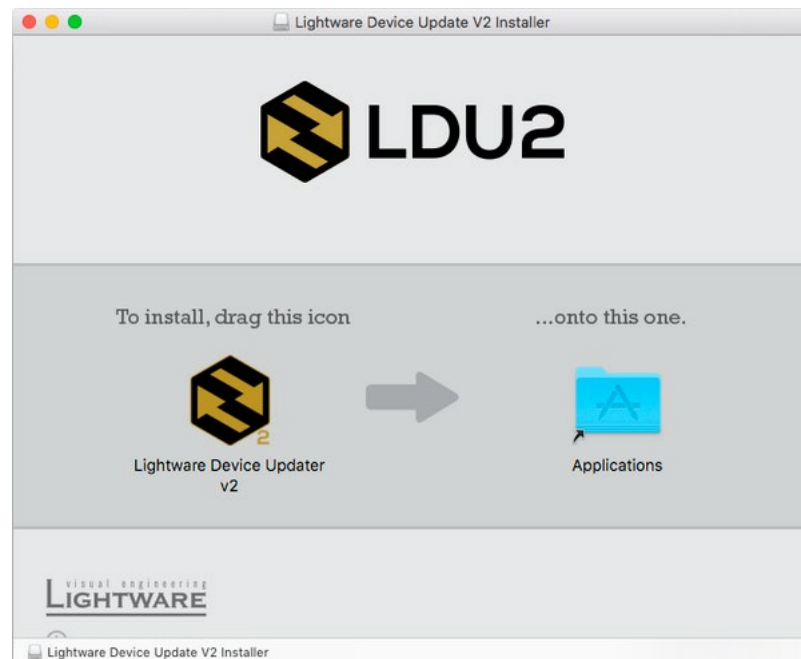

8.3. Running the Software

You have two options:

- **Starting the LDU2** by double-clicking on the shortcut/program file, or
- Double-clicking on an **LFP2 file**.

LDU2 Auto-Update

At startup, the software checks if a newer version is available on the web.

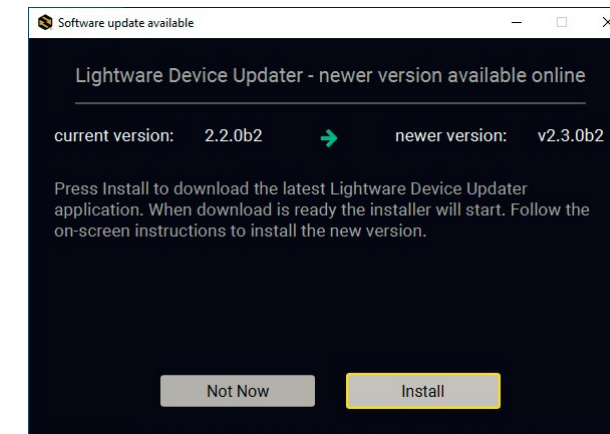

Main Screen

When the software is started by the shortcut, the device discovery screen appears. Press the **Search for devices** button to start finding the Lightware devices:

SEARCH FOR DEVICES

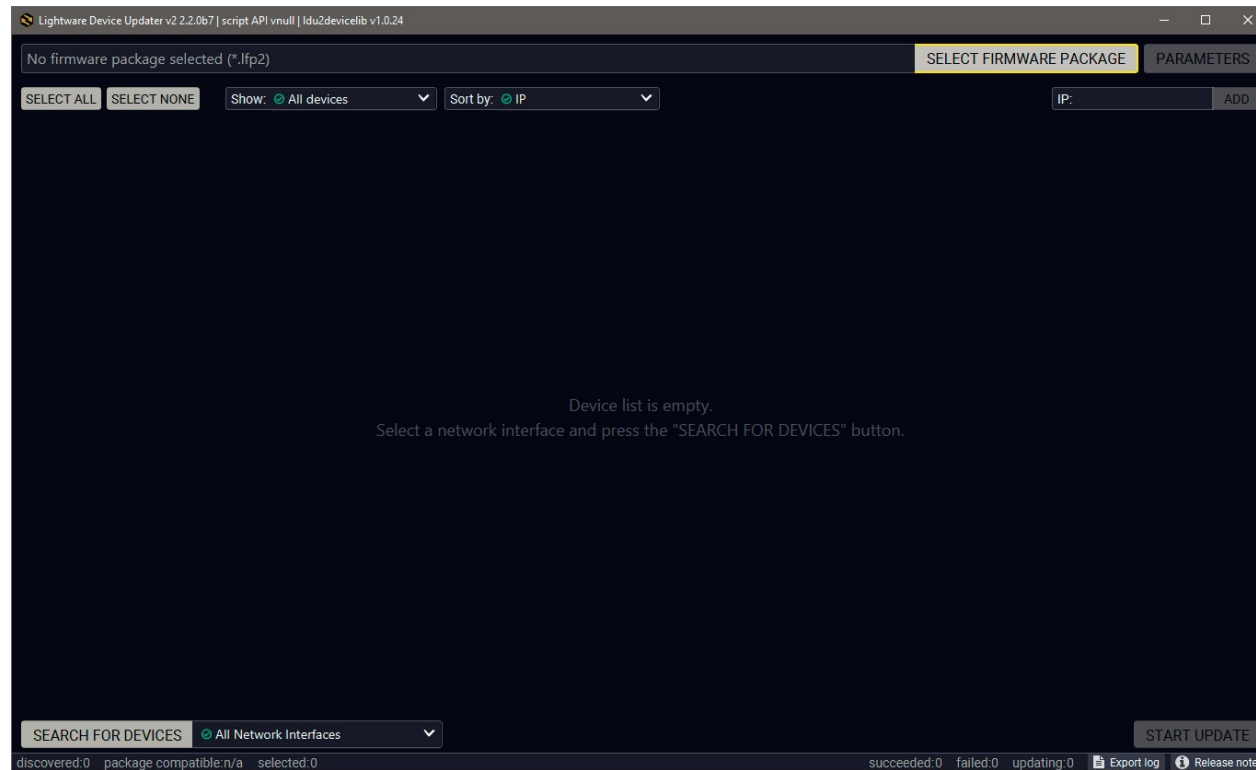

If you start the software by double-clicking on the LFP2 file, the firmware will be loaded. Press the **Search for devices** button; all the devices will be listed which are compatible with the selected firmware pack.



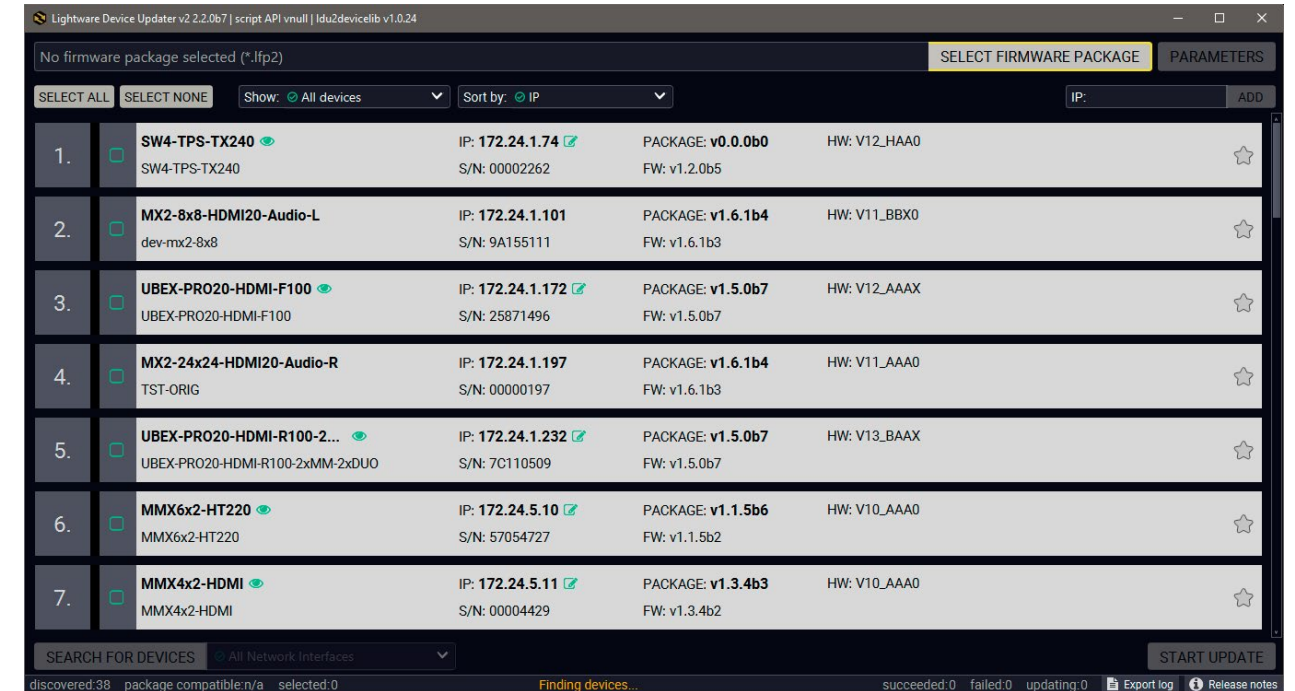

INFO: If you press the **Select firmware package** button, the release notes of the LFP2 file will be displayed in the right panel; see the [Step 1. Select the Firmware Package](#). section.

Device List

When the discovery has completed, the devices available on the network are listed in the application.



Legend of the Icons

-  **IP address editor** The IP address of the device can be changed in the pop-up window.
-  **Identify me** Clicking on the icon results the front panel LEDs blink for 10 seconds which helps to identify the device physically.
-  **Favorite device** The device has been marked, thus the IP address is stored. When a device is connected with that IP address, the star will highlighted in that line.
-  **Further information available** Device is unreachable. Change the IP address using the front panel LCD menu or the IP address editor of the LDU2.

8.4. The Upgrading Steps

ATTENTION! While the firmware is being upgraded, the normal operation mode is suspended as the device is switched to bootload mode. Signal processing is not performed. Do not interrupt the firmware upgrade. If any problem occurs, reboot the unit and restart the process.

Keeping the Configuration Settings

By default, device configuration settings are restored when firmware upgrade is finished. If factory reset has been chosen in the parameters window, all device settings will be erased. In the case of factory reset, you can save the settings of the device in the Lightware Device Controller software and restore it later.

The following flow chart demonstrates how this function works in the background.

1. Create a backup

The current configuration of the device is being saved into a configuration backup file on your computer.

2. Start the Upgrade

The device reboots and starts in bootload mode (firmware upgrade mode).

3. Upgrade

The CPU firmware is changed to the new one.

4. Factory reset

All configuration settings are restored to the factory default values.

5. Conversion / Restore

The firmware package checks the backup data before the restore procedure, and if it is necessary, a conversion is applied to avoid incompatibility problems between the firmware versions. All configuration settings are restored to the device after the conversion.

If the factory default option is selected in the Parameters window, the conversion / restore procedure will not be performed!

6. Finish

Once the firmware upgrade procedure is finished, the device reboots and is ready to use.

Step 1. Select the Firmware Package.

Click on the **Select Firmware Package** button and navigate to the location where the LFP2 file was saved. When you click on the name of package, the preview of the release notes are displayed in the right panel.

SELECT FIRMWARE PACKAGE

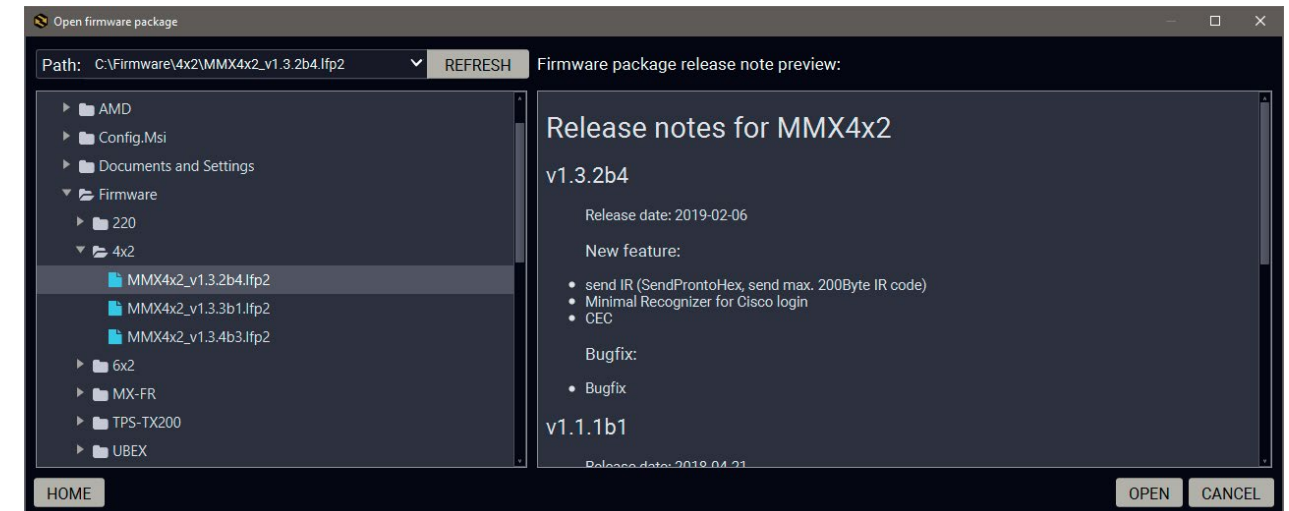

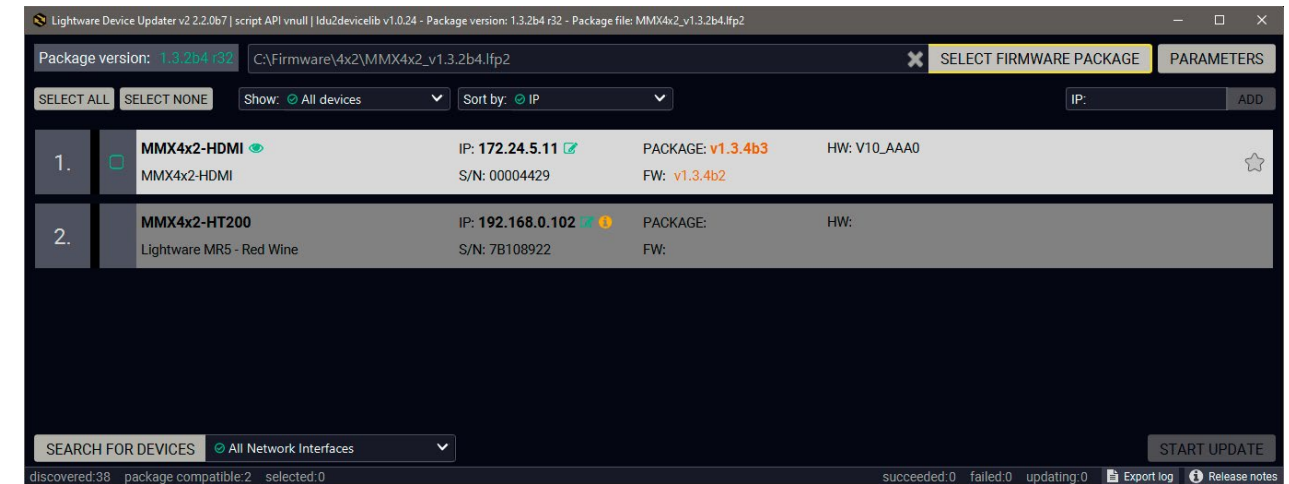

After the package file is loaded, the list is filtered to show the compatible devices only. The current firmware version of the device is highlighted in orange if it is different from the version of the package loaded.



INFO: If you start the upgrade by double-clicking on the LFP file, above screen will be loaded right away.

The Meaning of the Symbols

- | | | |
|---|--------------|--|
|  | Show details | The log about the upgrading process of the device can be displayed in a new window. |
|  | Service mode | The device is in bootload mode. Backup and restore cannot be performed in this case. |

Step 2. Select the desired devices for upgrading.

Select the devices for upgrading; the selected line will be highlighted in green.

If you are not sure which device to select, press the **Identify me**  button. It makes the front panel LEDs blink for 10 seconds. The feature helps to find the device physically.

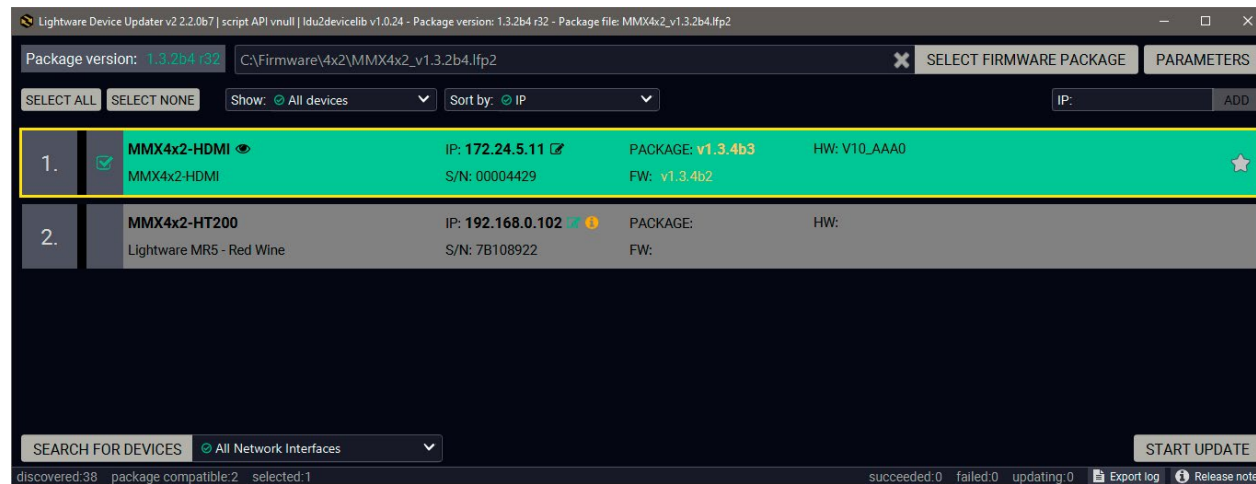

Step 3. Check the upgrade parameters.

DIFFERENCE: The appearing settings are device-dependent and can be different device by device.

Clicking on the **Parameters** button, special settings will be available like:

PARAMETERS

- Creating a backup about the configuration,
- Restore the configuration or reloading the factory default settings after the firmware upgrade,
- Uploading the default Miniweb (if available). `#builtinweb` `#miniweb` `#web`

Please arrange the settings carefully.

Step 4. Start the update and wait until it is finished.

Click on the **Start Update** button to start the procedure. The status is shown in percent in the right side of the device line and the overall process in the bottom progress bar.

START UPDATE

INFO: The device might reboot during the firmware upgrade procedure.

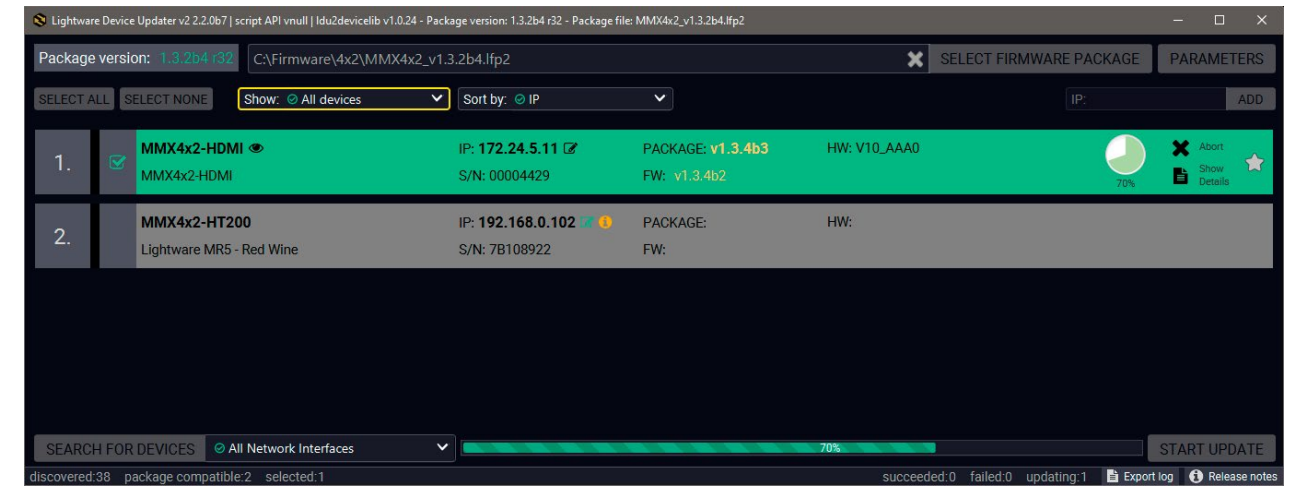

When the progress bar reaches 100% (**Done** is displayed at all devices), the upgrade of all devices are finished successfully and a message appears; you can close the software.

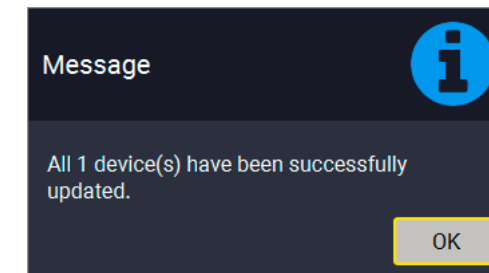

Step 5. Wait until the unit reboots with the new firmware.

Once the firmware upgrade procedure is completed, the device is rebooted with the new firmware. Shutting down and restarting the device is recommended.

8.5. If the Upgrade is not successful

- Restart the process and try the upgrade again.
- If the device cannot be switched to bootload (firmware upgrade) mode, you can do that manually as written in the User's manual of the device. Please note that backup and restore cannot be performed in this case.
- If the backup cannot be created for some reason, you will get a message to continue the process without backup or stop the upgrade. A root cause can be that the desired device is already in bootload (firmware upgrade) mode, thus, the normal operation mode is suspended and backup cannot be made.
- If an upgrade is not successful, the **Export log** button becomes red. If you press the button, you can download the log file as a ZIP package which can be sent to Lightware Support if needed. The log files contain useful information about the circumstances to find the root cause. *#bootload*





9















Troubleshooting





















Usually, if the system seems not to transport the signal as expected, the best strategy for troubleshooting is to check signal integrity through the whole signal chain starting from source side and moving forward to receiver end.



















9.1. Use Case Studies

At first, check front panel LEDs and take the necessary steps according to their states. For more information about status LEDs refer to the [Front Panel LEDs](#) and [Rear Panel LEDs](#) sections.

-  Link to connections/cabling section.
-  Link to device operation section.
-  Link to LDC software section.
-  Link to LW2 protocol commands section.
-  Link to LW3 protocol commands section.

Symptom	Root cause	Action	Refer to
Video signal			
No picture on the video output	Device or devices are not powered properly	Check the matrix and the other devices if they are properly powered; try to unplug and reconnect them.	 3.3
	Cable connection problem	Cables must fit very well, check all the connectors (video and TPS cables).	 3.2
	No incoming signal	If the SIGNAL LED of the input port does not light, no signal is present. Check the source device(s) and the HDMI/CATx cable(s).	 2.4 2.5
	TPS mode problem	Check the actual TPS mode and the selected modes of the devices.	 5.5.1  7.5.21
	Not the proper video port is the active one	Check the video crosspoint settings.	 2.4  5.4  6.4.6  7.5.3
	The output is muted	Check the mute state of output port.	 5.4.3  6.4.2  7.5.2
	Display is not able to receive the video format	Check the emulated EDID; select another (e.g. emulate the EDID of the display on the input port).	 5.8  7.18.1

Symptom	Root cause	Action	Refer to
	HDCP is disabled	Enable HDCP on the input and output port.	 5.5  7.5.17  7.5.18
Not the desired picture displayed on the video output	Video output is set to test pattern (no sync screen) statically	Check Test Pattern settings in the HDMI output properties.	 5.8  7.5.19
	Video output is set to test pattern (no sync screen) as there is no picture on video source	Check video settings of the source.	 7.5.19
Audio signal			
No audio is present on output	Source audio volume is low or muted	Check the audio settings of the source.	
	Not the proper audio port is the active one	Check the audio crosspoint settings.	 5.4  6.4.6  7.7.1  7.7.2
	Input port is muted	Check the input port properties.	 5.5.2  7.6.1
	Output port is muted	Check the output port properties.	 5.5.3  6.4.3  7.5.2
	Analog audio volume is set low	Check the Analog audio output port settings (volume).	 5.5.6  7.7.8
HDMI output signal contains no audio	HDMI mode was set to DVI	Check the properties of the output port and set to HDMI or Auto.	 5.5.3  7.5.20
	DVI EDID is emulated	Check the EDID and select and HDMI EDID to emulate.	 5.8  7.18.1

Symptom	Root cause	Action	Refer to
RS-232 signal			
Connected serial device does not respond	Cable connection problem	Check the connectors to fit well; check the wiring of the plugs.	 11.8
	RS-232 settings are different	Check the port settings of the transmitter and/or the matrix and the connected serial device(s). Pay attention to Link and/or Local ports.	 5.9.1  7.10
	RS-232 mode is not right	Check the RS-232 mode settings (control, command injection, or disconnected)	 5.9.1  7.10
	Messaging via serial port is not working	Check the serial messaging rules and/or apply escaping in the message.	 7.11
Network			
No LAN connection can be established	Incorrect IP address is set (fix IP)	Use dynamic IP address by enabling DHCP option.	 2.6.3  5.11  6.5.2  7.8.1
		Restore the factory default settings (with fix IP).	 2.6.4  5.11  6.3.11  7.4.3
	IP address conflict	Check the IP address of the other devices, too.	
	TCP/IP or UDP messaging via LAN port is not working	Check the TCP/IP / UDP messaging rules and/or apply escaping in the message.	 7.9
Miscellaneous			
Front panel buttons are out of operation	The buttons are locked	Disable control lock.	 2.6.6  5.11.1  7.4.5
Error messages received always	Different protocol is set	Check the protocol settings (LW2 / LW3) and use the proper protocol commands.	 5.9
CEC message sending does not work	The CEC feature is not enabled in the connected (third-party) device	Check the device and/or its documentation to enable the feature.	

9.2. How to Speed Up the Troubleshooting Process

Lightware's technical support team is always working hard to provide the fastest support possible. Our team's response time is one of the best in the industry and in the toughest of cases we can directly consult with the hardware or software engineer who designed the product to get the information from the most reliable source.

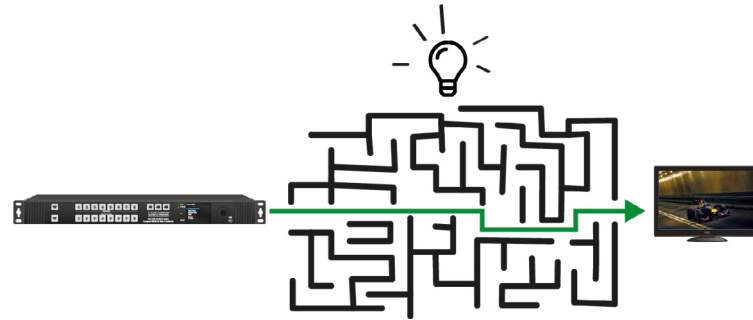

However, the troubleshooting process can be even faster... with your help.

There are certain pieces of information that push us in the right direction to finding the root cause of the problem. If we receive most of this information in the first e-mail or it is gathered at the time when you call us, then there is a pretty high chance that we will be able to respond with the final solution right away.

This information is the following:

- Schematic (a pdf version is preferred, but a hand drawing is sufficient).
- Serial number(s) of the device(s) (it is either printed somewhere on the box or you can query it in the Device Controller software or on the built-in website).
- Firmware versions of the devices (please note that there may be multiple CPUs or controllers in the device and we need to know all of their firmware versions, a screenshot is the best option).
- Cable lengths and types (in our experience, it's usually the cable).
- Patch panels, gender changers or anything else in the signal path that can affect the transmission.
- Signal type (resolution, refresh rate, color space, deep color).
- Emulated EDID(s) (please save them as file and send them to us).
- Actions to take in order to re-create the problem (if we cannot reproduce the problem, it is hard for us to find the cause).
- Photo or video about the problem ('image noise' can mean many different things, it's better if we see it too).
- Error logs from the Device Controller software.
- In the case of Event Manager issue the event file and/or backup file from the Device Controller software.

The more of the above information you can give us the better. Please send these information to the Lightware Support Team (support@lightware.com) to speed up the troubleshooting process.

10

Technologies

The following sections contain descriptions and useful technical information how the devices work in the background. The content is based on experiences and cases we met in the practice. These sections help to understand features and technical standards.

- ▶ [EDID MANAGEMENT](#)
- ▶ [HDCP MANAGEMENT](#)
- ▶ [PIXEL ACCURATE RECLOCKING](#)

10.1. EDID Management

10.1.1. Understanding the EDID

The Extended Display Identification Data (EDID) is the passport of display devices (monitors, TV sets, projectors). It contains information about the capabilities of the display, such as supported resolutions, refresh rates (these are called Detailed Timings), the type and manufacturer of the display device, etc.

After connecting a source to a display (DVI, HDMI, DP), the source reads out the EDID to determine the resolution and refresh rate of the image to be transmitted.

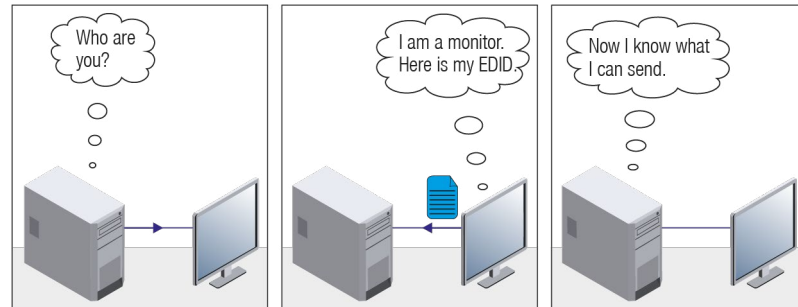

EDID Communication

Most DVI computer displays have 128-byte long EDID structure. However, Digital Televisions and HDMI capable displays may have another 128 bytes, which is called E-EDID and defined by CEA (Consumer Electronics Association). This extension contains information about additional Detailed Timings, audio capabilities, speaker allocation and HDMI capabilities. It is important to know that all HDMI capable devices must have CEA extension, but not all devices with CEA extension are HDMI capable.

Common Problems Related to EDID

Problem: “My system consists of the following: a computer, a Lightware device, a WUXGA (1920x1200) LCD monitor, and an SXGA (1280x1024) projector. I would like to see the same image on the monitor and the projector. What EDID should I choose on the Lightware device?”

Solution: If you want to see the image on both displays, you need to select the resolution of the smaller display (in this case SXGA), otherwise the smaller display may not show the higher resolution image.

Problem: “I have changed to a different EDID on an input port of the Lightware device to have a different resolution but nothing happens.”

Solution: Some graphics cards and video sources read out the EDID only after power-up and later they do not sense that EDID has been changed. You need to restart your source to make it read out the EDID again.

10.1.2. Advanced EDID Management

Each DVI sink (e.g. monitors, projectors, plasma displays, etc...) must support the EDID data structure. Source BIOS and operating systems are likely to query the sink using DDC2B protocol to determine what pixel formats and interface are supported. DVI standard uses EDID data structure to identify the monitor type and capabilities. Most DVI sources (VGA cards, set top boxes, etc.) will output DVI signal after accepting the connected sink's EDID information. In the case of EDID readout failure or missing EDID, the source will not output DVI video signal.

Lightware devices provide the Advanced EDID Management function that helps system integration. The built-in EDID Router can store and emulate factory pre-programmed- and User programmable EDIDs. The EDID of the attached monitors or projectors for each output are stored in a non-volatile memory. This way the EDID of a monitor is available when the monitor is unplugged or switched off.

Any EDID can be emulated on any input. An emulated EDID can be copied from the EDID router's memory (static EDID emulation), or from the last attached monitor's memory (dynamic EDID emulation). For example, the Lightware device can be set up to emulate a sink device, which is connected to one of the outputs. In this case, the EDID automatically changes, if the monitor is replaced with another display device (as long as it has a valid EDID).

EDID is independently programmable for all inputs without affecting each other. All inputs have their own EDID circuit.

INFO: The user is not required to disconnect the video cable to change an EDID as opposed to other manufacturer's products. EDID can be changed even if a source is connected to the input and powered ON.

INFO: When EDID has been changed, the router toggles the HOTPLUG signal for 2 seconds. Some sources do not sense this signal. In such cases, the source device must be restarted or powered OFF and ON again.

10.2. HDCP Management

Lightware Visual Engineering is a legal HDCP adopter. Several functions have been developed which helps to solve HDCP related problems. Complex AV systems often have both HDCP and non-HDCP components. The matrix allows transmitting HDCP encrypted and unencrypted signals. The devices will be still HDCP compliant as they will never output an encrypted signal to a non-HDCP compliant display device. If an encrypted signal is switched to a non-compliant output, a red screen alert or muted screen will appear.

10.2.1. Protected and Unprotected Content

Many video sources send HDCP protected signal if they detect that the sink is HDCP capable – even if the content is not copyrighted. This can cause trouble if an HDCP capable device is connected between the source and the display. In this case, the content cannot be viewed on non-HDCP capable displays and interfaces like event controllers. Rental and staging technicians often complain about certain laptops, which are always sending HDCP encrypted signals if the receiver device (display, matrix router, etc.) reports HDCP compliancy. However, HDCP encryption is not required all the time e.g. computer desktop image, certain laptops still do that.

To avoid unnecessary HDCP encryption, Lightware introduced the HDCP enabling/disabling function: the HDCP capability can be disabled in the Lightware device. If HDCP is disabled, the connected source will detect that the sink is not HDCP capable, and turn off authentication.

10.2.2. Disable Unnecessary Encryption

HDCP Compliant Sink

All the devices are HDCP-compliant, no manual setting is required, both protected and unprotected contents are transmitted and displayed on the sink.



Not HDCP-compliant Sink 1.

Not-HDCP compliant sink is connected to the matrix. Some sources (e.g. computers) always send HDCP encrypted signals if the receiver device reports HDCP compliancy, however, HDCP encryption is not required all the time (e.g. computer desktop image). If HDCP is enabled in the matrix, the image will not be displayed on the sink.



Setting the HDCP parameter to Auto on the output port and disable HDCP on the input port, the transmitted signal will not be encrypted if the content is not protected. Thus, non-HDCP compliant sinks will display non-encrypted signal.

Not HDCP-compliant Sink 2.

The layout is the same as in the previous case: non-HDCP compliant display device is connected to the matrix but the source would send protected content with encryption. If HDCP is enabled on the input port of the matrix, the source will send encrypted signal.



The sink is not HDCP compliant, thus, it will not display the video signal (but blank/red/muted/etc. screen). If HDCP is disabled on the input port of the matrix, the source will not send the signal. The solution is to replace the display device to an HDCP-capable one.

10.3. Pixel Accurate Reclocking

Signal reclocking is an essential important procedure in digital signal transmission. After passing the reclocking circuit, the signal becomes stable, jitter-free, and can be transmitted over more equipment like processors, or event controllers. Without reclocking, sparkles, noise, and jaggies appear on the image.

Lightware's sophisticated Pixel Accurate Reclocking technology fixes more problems than general TMDS reclocking. It removes not only intra-pair skew but inter-pair skew as well. The Pixel Accurate Reclocking circuit eliminates the following errors:

Intra-pair skew

Skew between the + and - wires within a differential wire pair (e.g. Data2- and Data2+). It's caused by different wire lengths or slightly different wire construction (impedance mismatch) in DVI cable. It results in jitter.

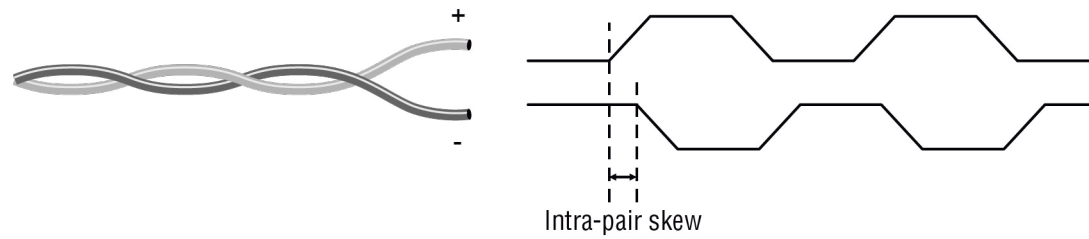

Inter-pair skew

Skew between two differential wire pairs in a cable. It is caused by different wire pair lengths or different number of twists in the DVI cable. Too much inter-pair skew results color shift in the picture or sync loss.

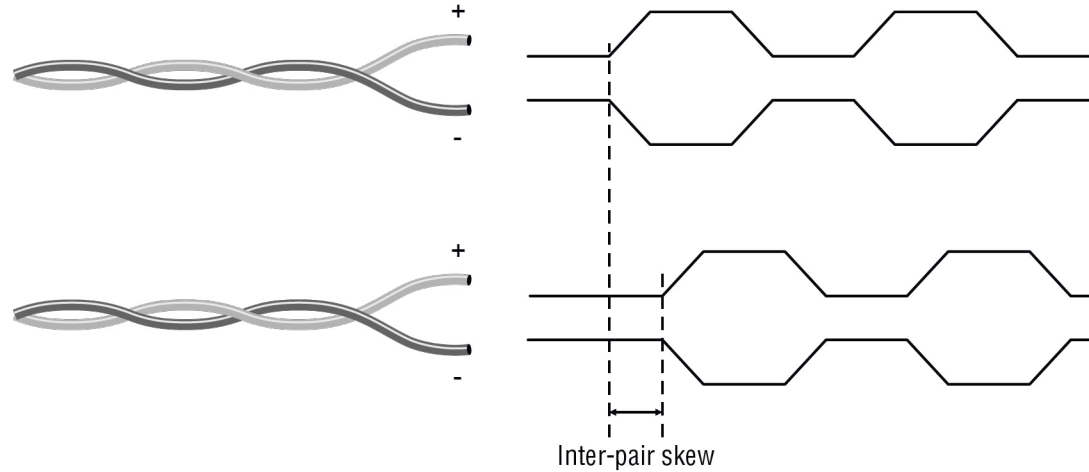

Jitter

Signal instability in the time domain. The time difference between two signal transitions should be a fixed value, but noise and other effects cause variations.

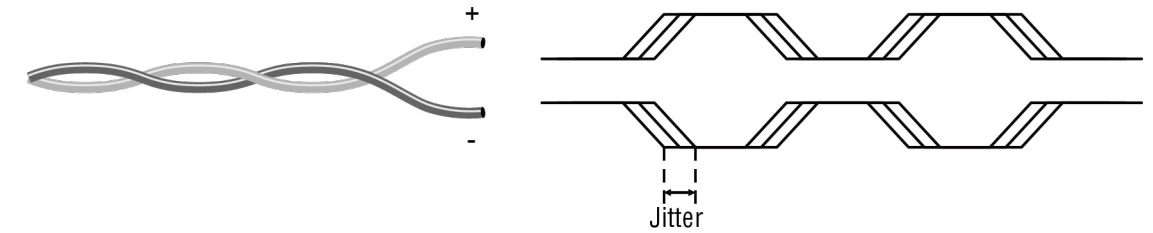

Noise

Electromagnetic interference between other electronic devices such as mobile phones, motors, etc. and the DVI cable are coupled onto the signal. Too much noise results in increased jitter.

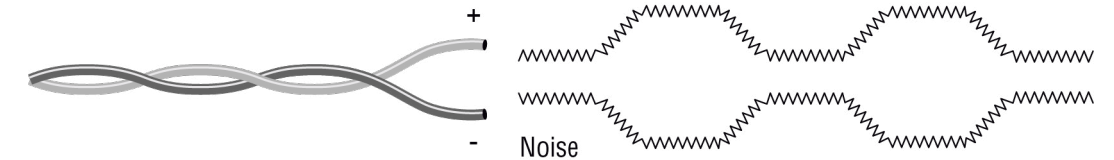

11

Appendix

Tables, drawings, guides, and technical details as follows:

- ▶ SPECIFICATIONS
- ▶ MAXIMUM EXTENSION DISTANCES
- ▶ FACTORY DEFAULT SETTINGS
- ▶ CONTENT OF BACKUP FILE
- ▶ INPUT/OUTPUT PORT NUMBERING
- ▶ MECHANICAL DRAWINGS
- ▶ CABLE WIRING GUIDE
- ▶ FACTORY EDID LIST
- ▶ FIRMWARE RELEASE NOTES
- ▶ LW3 COMMAND CHANGES IN FIRMWARE v1.2.0
- ▶ HASHTAG KEYWORD LIST
- ▶ FURTHER INFORMATION

11.1. Specifications

General

Compliance	CE
Safety.....	IEC/EN 62368-1:2014
EMC compliance (emission).....	IEC/EN 55032:2015
EMC compliance (immunity).....	IEC/EN 55035:2017
RoHS compliance	EN 50581:2012
Warranty	3 years
Operating temperature	0 to +50°C (+32 to +122°F)
Operating humidity	10% to 90%, non-condensing
Cooling.....	passive

Power

Power supply option.....	external power adaptor
--------------------------	------------------------

MMX4x2-HDMI

Power consumption (min/max).....	2 W / 4.6 W
Heat dissipation (min/max).....	7 BTU/h / 16 BTU/h

MMX4x2-HT200

Power consumption (min/max).....	3.6 W / 9.6W
Heat dissipation (min/max).....	12 BTU/h / 33 BTU/h

MMX4x2-HDMI-USB20-L

Power consumption (min/max).....	2 W / 18.1 W
Heat dissipation (min/max).....	7 BTU/h / 62 BTU/h

Power Adaptor

Supported power source.....	100-240 V AC; 50/60 Hz
Supplied power	12V 2A DC
AC power plug.....	interchangable (EU, UK, JP/US, AUS/NZ)
DC power plug.....	locking DC connector (2.1/5.5 mm pin)

Enclosure

Enclosure material.....	1 mm steel
-------------------------	------------

MMX4x2-HDMI and MMX4x2-HT200

Dimensions in mm.....	221 W x 100.4 D x 26 H
-----------------------	------------------------

Dimensions in inch	8.7 W x 3.95 D x 1.02 H
Weight (MMX4x2-HDMI and HT200).....	625 g

MMX4x2-HDMI-USB20-L

Dimensions in mm.....	221 W x 100.4 D x 42.5 H
Dimensions in inch	8.7 W x 3.95 D x 1.68 H
Weight (MMX4x2-HDMI-USB20-L).....	703 g

Video Inputs

HDMI Input

Connector type.....	19-pole HDMI Type A receptacle
A/V standard.....	DVI 1.0, HDMI 1.4
HDCP compliance.....	HDCP 1.4
Color space	RGB, YCbCr
Video delay.....	0 frame
Supported resolutions at 8 bits/color * up to 4096x2048@30Hz (4:4:4) or 4096x2048@60Hz (4:2:0) up to 3840x2160@30Hz (4:4:4) or 3840x2160@60Hz (4:2:0) up to 1920x1080@60Hz (4:4:4) up to 12 bits/color
Reclocking.....	Pixel Accurate Reclocking
3D support.....	yes
Audio formats	8 channel PCM Dolby TrueHD, DTS-HD Master Audio 7.1

* All standard VESA, CEA and other custom resolutions up to 300MHz (HDMI1.4) are supported.

TPS Input Port (MMX4x2-HT200)

Connector type.....	RJ45 connector
Compliance	HDBaseT™
HDCP compliance.....	HDCP 1.4
Transferred signals.....	Video, Audio, RS-232, Infrared, Ethernet
Color space	RGB, YCbCr
Video delay.....	0 frame
Supported resolutions at 8 bits/color * up to 4096x2048@30Hz (4:4:4) or 4096x2048@60Hz (4:2:0) up to 3840x2160@30Hz (4:4:4) or 3840x2160@60Hz (4:2:0) up to 1920x1080@60Hz (4:4:4) up to 12 bits/color

.....	up to 4096x2048@30Hz (4:4:4) or 4096x2048@60Hz (4:2:0)
.....	up to 3840x2160@30Hz (4:4:4) or 3840x2160@60Hz (4:2:0)
.....	1920x1080@60Hz (4:4:4) up to 12 bits/color
Audio formats	8 channel PCM Dolby TrueHD, DTS-HD Master Audio 7.1

* All standard VESA, CEA and other custom resolutions up to 300MHz (HDMI1.4) are supported.

HDMI Output Ports

The specifications of the output port are the same as in case of the input port.

Audio Ports

Analog Audio Input

Connector type.....	5-pole Phoenix connector
Audio formats	2-ch PCM
Sampling frequency.....	48 kHz
Signal transmission	balanced / unbalanced signal
Gain.....	-12 dB – +6 dB

Analog Audio Output

Connector type.....	5-pole Phoenix connector
Audio formats	2-ch PCM
Sampling frequency.....	48 kHz
Signal transmission	balanced / unbalanced signal
Balance.....	0 - 100 (50 = center)
Volume.....	-57 dB – 0 dB

USB 2.0 Ports (MMX4x2-HDMI-USB20-L)

Connector type.....	A-type receptacle (4x), B-type receptacle (4x)
USB compliance.....	USB 2.0
Output power over USB-A ports.....	max. 500 mA*

* USB port 1 can supply up to 1000 mA.

ATTENTION! The sum of the current that the GPIO and the USB-A ports can supply together is max. 2A.

Control Ports

RS-232 Serial Port *

Connector type..... 3-pole Phoenix connector
 Baud rates Between 4800 and 115200 Baud
 Data bits 8 or 9
 Parity..... None / Odd / Even
 Stop bits 1 / 1.5 / 2

* MMX4x2-HDMI-USB20-L model is assembled with two RS-232 ports.

USB Control Port (Front Panel)

Connector type..... mini-B type

Infrared Port

Input connector type..... 3.5 mm TRS (approx. 1/8" jack)
 Output connector type..... 3.5 mm TS (approx. 1/8" jack)
 Input carrier frequency 38 kHz
 Output signal.....modulated (38 kHz)

Ethernet

Ethernet port
 Connector type..... EtherCON, RJ45 female connector
 Ethernet data rate 10/100Base-T, full duplex with autodetect
 Power over Ethernet (PoE)Not supported

GPIO Port (MMX4x2-HDMI-USB20-L)

Connector type..... 8-pole Phoenix connector
 Number of configurable pins 6
 Port direction..... Input or output
 Function of the 6th pin..... supplying constant 5V

ATTENTION! The sum of the current that the GPIO and the USB-A ports can supply together is max. 2A.

INFO: Specifications subject to change without notice.

11.2. Maximum Extension Distances

DIFFERENCE: This section refers to the MMX4x2-HT200 model only.

Resolution	Pixel clock rate	Cable lengths (Auto / Longreach TPS mode)		
		CAT5e AWG24	CAT7 AWG26**	CAT7 AWG23
1024x768@60Hz	65 MHz	100 m / 130 m*	90 m / 120 m*	120 m / 170 m*
1280x720p@60Hz	73.8 MHz	100 m / 130 m*	90 m / 120 m*	120 m / 170 m*
1920x1080p@60Hz / 24bpp	148.5 MHz	100 m / 130 m*	90 m / 120 m*	120 m / 170 m*
1920x1200@60Hz	152.9 MHz	100 m / NA	90 m / NA	120 m / NA
1600x1200@60Hz	162 MHz	100 m / NA	90 m / NA	120 m / NA
1920x1080@60Hz / 36bpp	223.6 MHz	70 m / NA	70 m / NA	100 m / NA
3840x2160@30Hz UHD	297 MHz	70 m / NA	70 m / NA	100 m / NA
4096x2160@30Hz 4K	297 MHz	70 m / NA	70 m / NA	100 m / NA

* With Long reach operation mode which supports pixel clock frequencies up to 148.5 MHz.

** When remote powering is used with AWG26 cables, distances are 20% shorter.

To specify the accurate extension distances, please also check the documentation of the connected HDBaseT-compatible device.

11.3. Input/Output Port Numbering

11.3.1. MMX4x2-HDMI and MMX4x2-HDMI-USB20-L

Audio/Video Ports

Port name	Video port nr. (LW2)	Video port nr. (LW3)	Audio port nr. (LW2)	Audio port nr. (LW3)	
				Till fw v1.1.0	From fw v1.2.0
Inputs	HDMI in 1	1	I1	1	A1 / A2 (depends on the selected video output)
	HDMI in 2	2	I2	2	
	HDMI in 3	3	I3	3	
	HDMI in 4	4	I4	4	
	Analog audio in	-	-	5	
Outputs	HDMI out 1	1	O1	1	O1
	HDMI out 2	2	O2	2	O2
	Analog audio out	-	-	3	O3

IR and RS-232 Ports

Port name	Port nr. (LW3)
Local IR input	S1
Local IR output	D1

Port name	Port nr. (LW3)
Local serial port	P1
Local serial port #2 *	P2

* Only in case of MMX4x2-HDMI-USB20-L model.

11.3.2. MMX4x2-HT200**Audio/Video Ports**

	Port name	Video port nr. (LW2)	Video port nr. (LW3)	Audio port nr. (LW2)	Audio port nr. (LW3)	
					Till fw v1.1.0	From fw v1.2.0
Inputs	TPS in 1	1	I1	1	I1	A1 / A2 (depends on the selected HDMI output)
	HDMI in 2	2	I2	2	I2	
	HDMI in 3	3	I3	3	I3	
	HDMI in 4	4	I4	4	I4	
	Analog audio in	-	-	5	I5	
Outputs	HDMI out 1	1	O1	1	O1	O1
	HDMI out 2	2	O2	2	O2	O2
	Analog audio out	-	-	3	O3	O3

IR and RS-232 Ports

Port name	Port nr. (LW3)
Local IR input	S1
Local IR output	D1
TPS IR input	S2
TPS IR output	D2

Port name	Port nr. (LW3)
Local serial port	P1
TPS serial link	P2

11.4. Content of Backup File

The backup file contains numerous settings and parameters saved from the device. When the file is uploaded to a device, the followings will be overwritten:

Audio / Video crosspoint settings
Mute status, Lock status, Switch state
Autoselect mode, Port priority
TPS / HDMI input ports
Video port name, Audio port name, HDCP setting
HDMI output ports
Port name, HDCP mode, HDMI mode, Power +5V mode
Test pattern mode, clock source, and type
Audio port name, Audio output enabled, S/PDIF mode
Analog audio input port
Port name, Volume, Balance, Gain
Analog audio output port
Port name, Volume, Balance
Local and TPS serial port
RS-232 mode, Control protocol, Baud rate, Data bits, Stop bits, Parity
Port name and CI (Command Injection) port number
Local and TPS IR port
Port status (enable / disable), Code length, Repetition code, Enable modulation
Input port name, Output port name
CI status (enable / disable), CI port number
Saved IR codes, names
Network settings
DHCP status (enable / disable)
Static IP address, Network mask, Gateway address
Further settings
Control lock status, Device label
User EDID data (U1-U14), Emulated EDIDs by ports
Presets (1-4)
Event manager: settings of all Events (E1-E100)

11.6. Factory Default Settings

Parameter	Setting/Value
Video crosspoint settings	
O1 (HDMI out 1) - MMX4x2-HDMI	I1 (HDMI in 1)
O1 (HDMI out 1) - MMX4x2-HT200	I1 (TPS in 1)
O2 (HDMI out 2) - for both models	I2 (HDMI in 2)
Audio crosspoint settings	
O1 (HDMI out 1)	A1 (original HDMI embedded audio)
O1 (HDMI out 1)	A2 (original HDMI embedded audio)
O3 (Audio out)	A3 (analog audio input)
Video input port settings	
TPS mode *	Auto
HDCP	Enabled
Test pattern mode	Disabled
Test pattern clock source	480p
Test pattern	Bar
Video output port settings	
Autoselect feature	Disabled
Autoselect mode	Priority detect
Signal type	Auto
HDCP mode	Auto
Power 5V mode	Always on
Emulated EDID on all four inputs	Factory #47: Universal HDMI PCM
Analog audio input port settings	
Volume	0.00 dB (100%)
Balance	0 (center)
Gain	0.00 dB
Analog audio output port settings	
Volume	0.00 dB (100%)
Balance	0 (center)
Network settings	
IP address	192.168.0.100
Subnet mask	255.255.255.0
Static gateway	192.168.0.1
DHCP	Disabled

Parameter	Setting/Value
LW2 port number	10001
LW3 port number	6107
HTTP port number	80
TPS Ethernet status	Enabled
RS-232 settings	
Control protocol	LW2
Baud rate	57600
Databits	8
Parity	No
Stopbits	1
Operation mode (Link and Local)	Control
Command injection port nr. - Local	8001
Command injection port nr. - TPS *	8002
IR port settings	
Command injection status	Enabled
Comm. inj. input port nr. - Local	9001
Comm. inj. input port nr. - TPS *	9002
Comm. inj. output port nr. - Local	9003
Comm. inj. output port nr. - TPS *	9003
Miscellaneous	
Unique port names	Cleared
Unique device label	Cleared
User EDIDs	Not cleared
Events	Cleared
IR codes	Cleared
Presets	Cleared
Unprotected backups	Cleared
Protected backups	Not cleared
USB 2.0 switch state	USB-A ports switched to PC1 port

* Only in case of MMX4x2-HT200 model.

11.7. Mechanical Drawings

11.7.1. 1/2 U High Devices

DIFFERENCE: The dimensions refer to the MMX4x2-HT200 and MMX4x2-HDMI models.

Front View

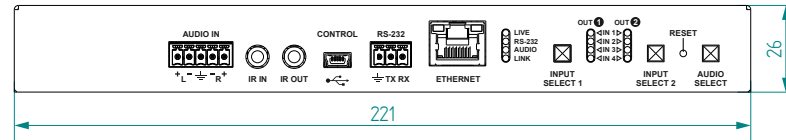

Top View

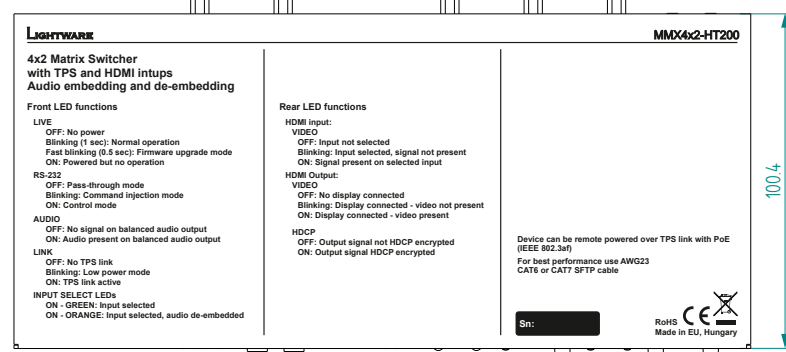

Rear View



Bottom View

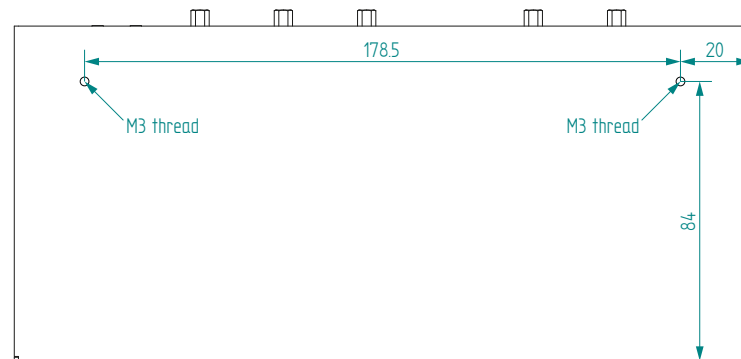

Side View

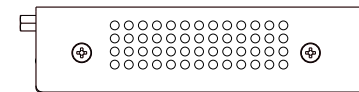

11.7.2. MMX4x2-HDMI-USB20-L

Front View

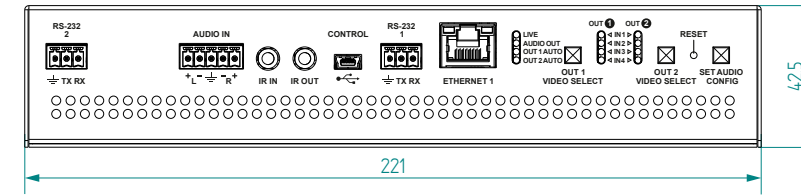

Top View

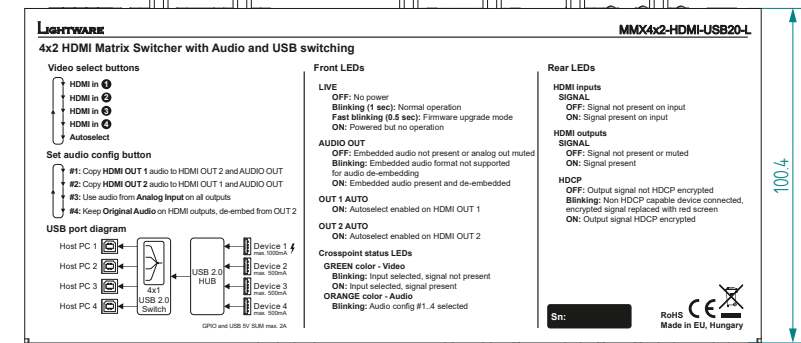

Rear View

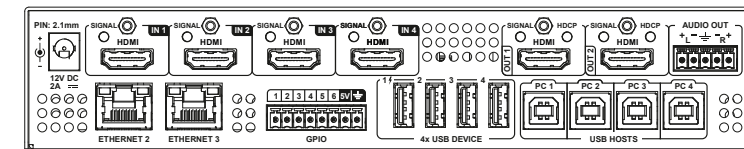

Bottom View

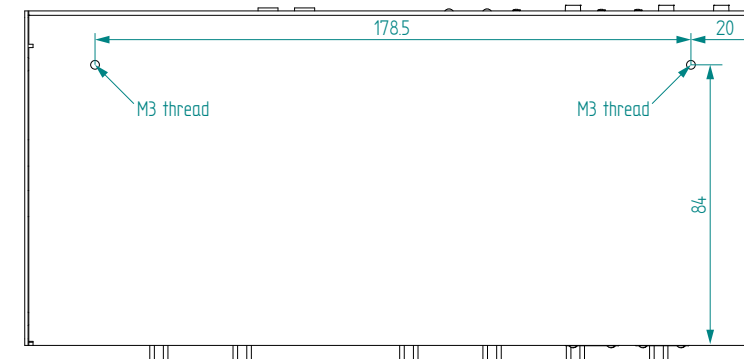

Side View

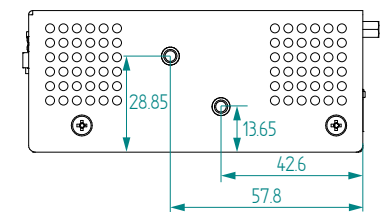

11.8. Cable Wiring Guide

Inputs and outputs of audio devices are symmetric or asymmetric. The main advantage of the symmetric lines is the better protection against the noise therefore, they are widely used in the professional audio industry. Symmetric audio is most often referred to as balanced audio, as opposed to asymmetric, which is referred to as unbalanced audio. Lighthouse products are usually built with 5-pole Phoenix connectors so we would like to help users assembling their own audio cables. See the most common cases below.

ATTENTION! Symmetric and asymmetric lines can be linked with passive accessories (e.g. special cables), but in this case half of the line level is lost.

ATTENTION! There are numerous types of regularly used connector and cable types to connect audio devices. Please always make sure that a connector or cable fits your system before use.

ATTENTION! Never join the phase-inverted (negative, cold or -) poles (either right and left) to the ground or to each other on the output side, as this can damage the unit.

INFO: Use a galvanic isolation in case of a ground loop.

11.8.1. Serial Ports

The device is built with 3-pole Phoenix connector. See the below examples of connecting to a DCE (Data Circuit-terminating Equipment) or a DTE (Data Terminal Equipment) type device:

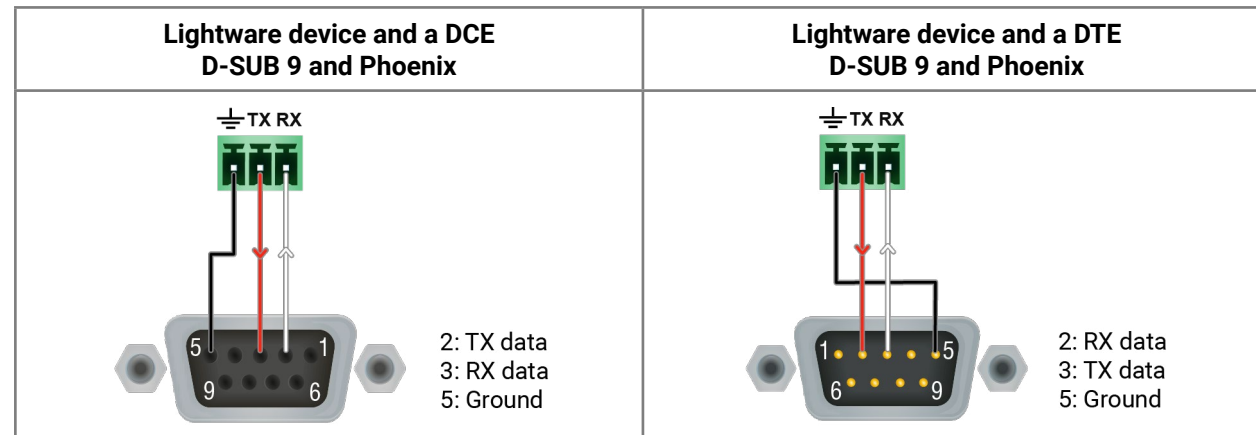

11.8.2. Audio Ports

The Pinout of the 5-pole Phoenix Connector

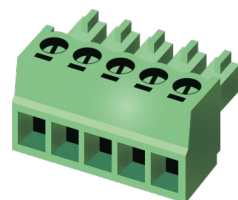

Pin nr.	Signal
1	Left+
2	Left-
3	Ground
4	Right-
5	Right+

Compatible Plug Type: Phoenix® Combicon series (3.5mm pitch, 5-pole), type: MC 1.5/5-ST-3.5.

From Unbalanced Output to Balanced Input

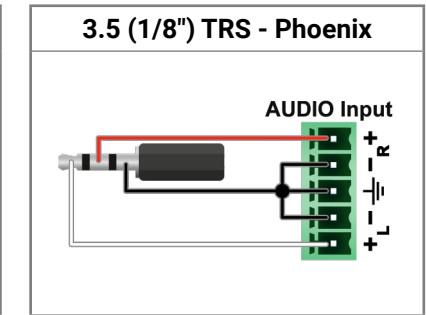
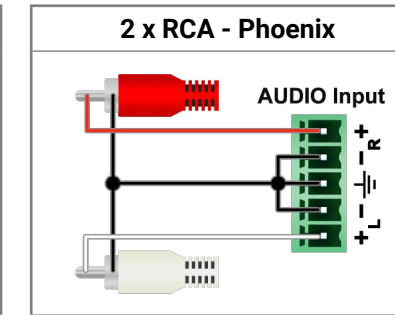
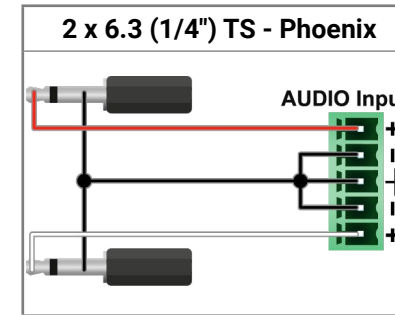

From Balanced Output to Unbalanced Input

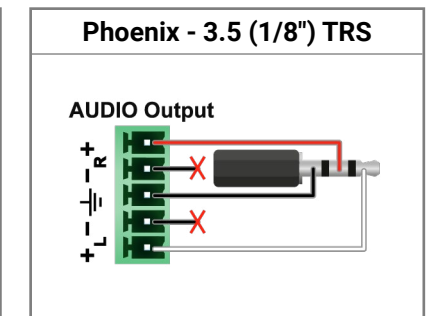
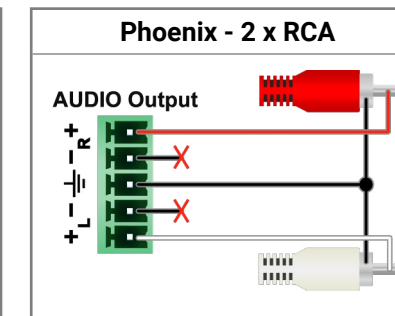
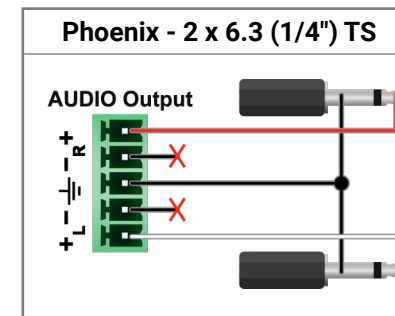

From Balanced Output to Balanced Input

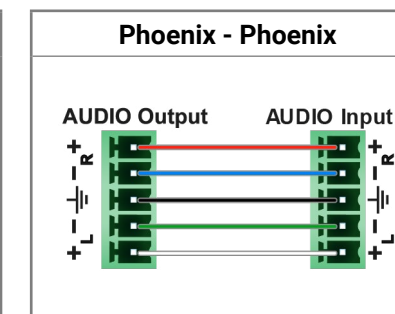
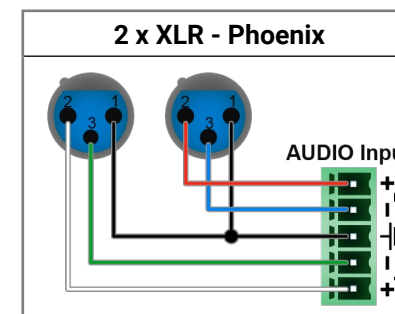
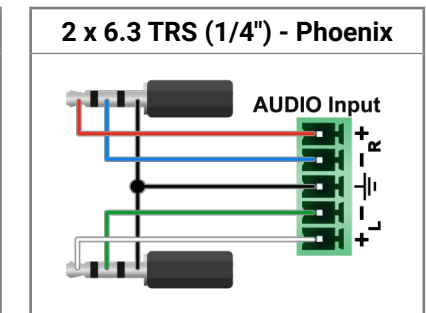
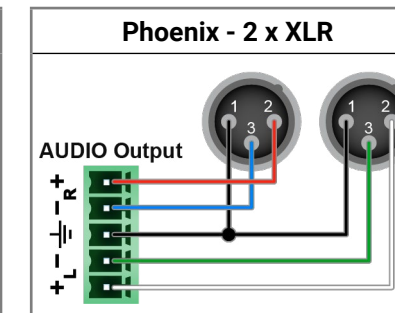
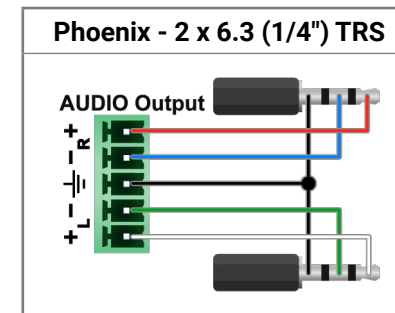

11.9. Factory EDID List

Mem.	Resolution			Scan type	EDID type
F1	640 x 480	@ 60.00	Hz	p	D
F2	848 x 480	@ 60.00	Hz	p	D
F3	800 x 600	@ 60.32	Hz	p	D
F4	1024 x 768	@ 60.00	Hz	p	D
F5	1280 x 768	@ 50.00	Hz	p	D
F6	1280 x 768	@ 59.94	Hz	p	D
F7	1280 x 768	@ 75.00	Hz	p	D
F8	1360 x 768	@ 60.02	Hz	p	D
F9	1280 x 1024	@ 50.00	Hz	p	D
F10	1280 x 1024	@ 60.02	Hz	p	D
F11	1280 x 1024	@ 75.02	Hz	p	D
F12	1400 x 1050	@ 50.00	Hz	p	D
F13	1400 x 1050	@ 60.00	Hz	p	D
F14	1400 x 1050	@ 75.00	Hz	p	D
F15	1680 x 1050	@ 60.00	Hz	p	D
F16	1920 x 1080	@ 50.00	Hz	p	D
F17	1920 x 1080	@ 60.00	Hz	p	D
F18	2048 x 1080	@ 50.00	Hz	p	D
F19	2048 x 1080	@ 60.00	Hz	p	D
F20	1600 x 1200	@ 50.00	Hz	p	D
F21	1600 x 1200	@ 60.00	Hz	p	D
F22	1920 x 1200	@ 50.00	Hz	p	D
F23	1920 x 1200	@ 59.56	Hz	p	D
F24	2048 x 1200	@ 59.96	Hz	p	D
F29	1920 x 1080	@ 60.00	Hz	p	U
F30	1440 x 480	@ 60.05	Hz	i	H
F31	1440 x 576	@ 50.08	Hz	i	H
F32	640 x 480	@ 59.95	Hz	p	H
F33	720 x 480	@ 59.94	Hz	p	H
F34	720 x 576	@ 50.00	Hz	p	H

Mem.	Resolution			Scan type	EDID type
F35	1280 x 720	@ 50.00	Hz	p	H
F36	1280 x 720	@ 60.00	Hz	p	H
F37	1920 x 1080	@ 50.04	Hz	i	H
F38	1920 x 1080	@ 50.00	Hz	i	H
F39	1920 x 1080	@ 60.05	Hz	i	H
F40	1920 x 1080	@ 60.05	Hz	i	H
F41	1920 x 1080	@ 24.00	Hz	p	H
F42	1920 x 1080	@ 25.00	Hz	p	H
F43	1920 x 1080	@ 30.00	Hz	p	H
F44	1920 x 1080	@ 50.00	Hz	p	H
F45	1920 x 1080	@ 59.94	Hz	p	H
F46	1920 x 1080	@ 60.00	Hz	p	H
F47	1920 x 1080	@ 60.00	Hz	p	U
F48	1920 x 1080	@ 60.00	Hz	p	U
F49	1920 x 1080	@ 60.00	Hz	p	U
F90	1920 x 2160	@ 59.99	Hz	p	D
F91	1024 x 2400	@ 60.01	Hz	p	D
F94	2048 x 1536	@ 60.00	Hz	p	D
F96	2560 x 1600	@ 59.86	Hz	p	D
F97	3840 x 2400	@ 24.00	Hz	p	D
F98	1280 x 720	@ 60.00	Hz	p	H
F99	1920 x 1080	@ 60.00	Hz	p	H
F100	1024 x 768	@ 60.00	Hz	p	H
F101	1280 x 1024	@ 50.00	Hz	p	H
F102	1280 x 1024	@ 60.02	Hz	p	H
F103	1280 x 1024	@ 75.02	Hz	p	H
F104	1600 x 1200	@ 50.00	Hz	p	H
F105	1600 x 1200	@ 60.00	Hz	p	H
F106	1920 x 1200	@ 59.56	Hz	p	H
F107	2560 x 1440	@ 59.95	Hz	p	H
F108	2560 x 1600	@ 59.86	Hz	p	H

Mem.	Resolution			Scan type	EDID type
F109	3840 x 2400	@ 24.00	Hz	p	H
F110	3840 x 2160	@ 24.00	Hz	p	H
F111	3840 x 2160	@ 25.00	Hz	p	H
F112	3840 x 2160	@ 30.00	Hz	p	H
F118	3840 x 2160	@ 30.00	Hz	p	U
F119	3840 x 2160	@ 30.00	Hz	p	U
F133	4096 x 2160	@ 60.00	Hz	p	4:2:0

Legend

D: DVI EDID

H: HDMI EDID

4:2:0: 4K UHD resolution with 4:2:0 subsampling

U: Universal EDID, supporting many standard resolutions:

- F29: Universal EDID for DVI signals (no audio support).
- F47: HDMI EDID supporting PCM audio.
- F48: HDMI EDID supporting all type of audio.
- F49: HDMI EDID supporting all type of audio and deep color.
- F118: HDMI EDID supporting PCM audio and 4K@30 Hz signals.
- F119: HDMI EDID supporting all type of audio and 4K@30 Hz signals.

Please note that minor changes in the factory EDID list may be applied in farther firmware versions.

11.10. Firmware Release Notes

Below list shows the released firmware packages with important notes.

v1.5.0b8

Release date: 2020-07-09

New feature:

- Support new products: MMX4x2-HDMI-USB20-L, MMX4x2-HDMI-USB20-Slim

Bugfix:

- Fixed issue with tick counter when the device is continuously operating for a very long time.

v1.3.4b3

Release date: 2019-05-24

New feature:

- sendProntoHex over TPS

Bugfix:

- Notification the user needs to update for the latest LDU2 version.
- Condition link was broken is fixed.

v1.3.1b6

Release date: 2019-02-06

New feature:

- Improved the Audio Crosspoint functionality
- Added 'Forced button lock' function to lock buttons via protocol command
- CEC - sendCEC command (e.g. turn on the TV with Event Actions)
- Sending IR codes (SendProntoHex e.g. send max. 200 Byte IR code with Event Actions)
- RS232 Minimal Recognizer for Cisco compatibility (Cisco Login)

v1.1.1b1

Release date: 2018-04-21

New feature:

- Improved the Audio Crosspoint functionality

v1.1.0b3

Release date: 2019-01-29

Bugfix:

- Fixed a bug that caused the RS232 ports didn't accept "00" as parameter of sendBinaryMessage

11.11. LW3 Command Changes in Firmware v1.2.0

If your MMX4x2 series matrix is built in to an A/V system and controlled by a system controller over LW3 commands, please note that the audio LW3 paths and nodes are changed in the firmware v1.2.0. The following tables summarizes the more important changes by categories.

The installed firmware version of the device can be seen in LDC software on the [Status](#) tab or can be queried by LW2 (see the [View Firmware Version of the CPU](#) section) or LW3 (see the [Querying the Firmware Version](#) section) protocol commands.

Paths

Description	Ceased Path (till firmware v1.1.0)	New Path (from firmware v1.2.0)
TPS input 1 / HDMI input 1	/MEDIA/AUDIO/I1	/MEDIA/AUDIO/A1 or /MEDIA/AUDIO/A2 <small>(depends on the selected video output)</small>
HDMI input port 2	/MEDIA/AUDIO/I2	
HDMI input port 3	/MEDIA/AUDIO/I3	
HDMI input port 4	/MEDIA/AUDIO/I4	
Analog audio input	/MEDIA/AUDIO/I5	/MEDIA/AUDIO/A3
Audio crosspoint	-	/MEDIA/AUDIO/XP

Commands

Description	Ceased Command (till firmware v1.1.0)	New Command (from firmware v1.2.0)
Embed analog audio input to O1	SET /SYS/MB/LEGACYAUDIOXP.EmbedAudioInputToHdmiOut1=true	CALL /MEDIA/AUDIO/XP:switch(A3:O1)
Transmit original HDMI audio on O1	SET /SYS/MB/LEGACYAUDIOXP.EmbedAudioInputToHdmiOut1=false	CALL /MEDIA/AUDIO/XP:switch(A1:O1)
Embed analog audio input to O2	SET /SYS/MB/LEGACYAUDIOXP.EmbedAudioInputToHdmiOut2=true	CALL /MEDIA/AUDIO/XP:switch(A3:O2)
Transmit original HDMI audio on O2	SET /SYS/MB/LEGACYAUDIOXP.EmbedAudioInputToHdmiOut2=false	CALL /MEDIA/AUDIO/XP:switch(A2:O2)
Transmit analog audio input to analog audio output	SET /SYS/MB/LEGACYAUDIOXP.EnableAnalogPassthrough=true	CALL /MEDIA/AUDIO/XP:switch(A3:O3)
De-embed HDMI audio of O2 to analog audio out	SET /SYS/MB/LEGACYAUDIOXP.EnableAnalogPassthrough=false	CALL /MEDIA/AUDIO/XP:switch(A2:O3)
Mute analog audio input	SET /MEDIA/AUDIO/I5.Mute=true	CALL /MEDIA/AUDIO/XP:muteSource(A3)
Unmute analog audio input	SET /MEDIA/AUDIO/I5.Mute=false	CALL /MEDIA/AUDIO/XP:unmuteSource(A3)
Mute analog audio output	SET /MEDIA/AUDIO/O3.Mute=true	CALL /MEDIA/AUDIO/XP:muteDestination(O3)
Unmute analog audio output	SET /MEDIA/AUDIO/O3.Mute=false	CALL /MEDIA/AUDIO/XP:unmuteDestination(O3)
Set gain on analog audio input	SET /MEDIA/AUDIO/I5.Gain=<value>	SET /MEDIA/AUDIO/A3.Gain=<value>

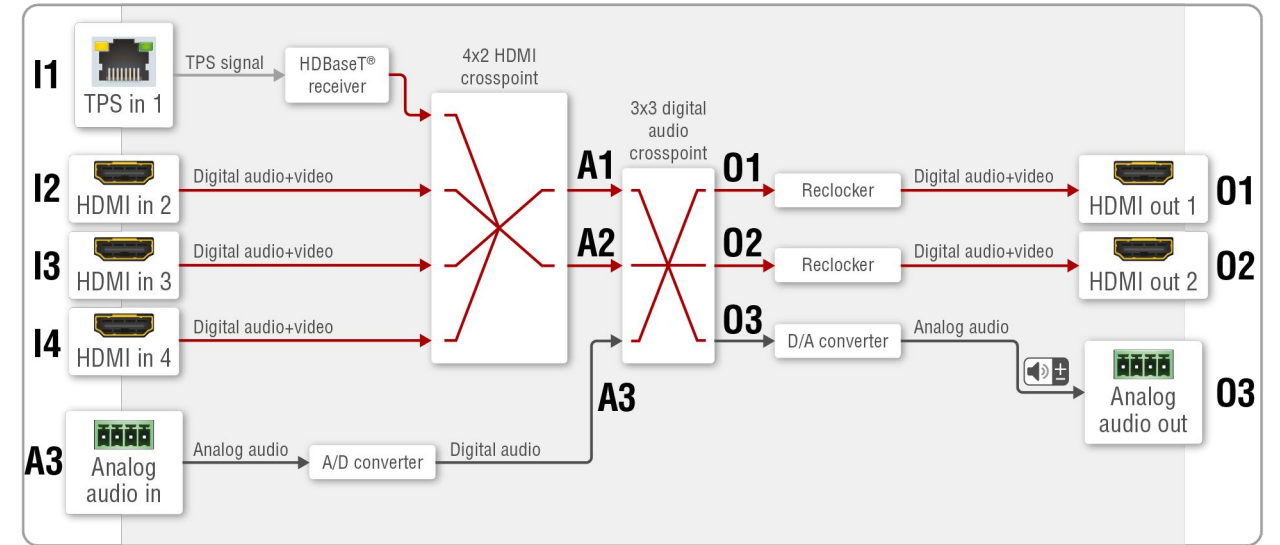

Port diagram of MMX4x2-HT200 for firmware v1.2.0

11.12. Hashtag Keyword List

This user's manual contains keywords with hashtag (#) to help you to find the relevant information as quick as possible.

The format of the keywords is the following:

#<keyword>

The usage of the keywords: use the **Search** function (Ctrl+F / Cmd+F) of your PDF reader application, type the # (hashtag) character and the wished keyword.

The **#new** special keyword indicates a new feature/function that has just appeared in the latest firmware or software version.

Example

#dhcp

This keyword is placed at the DHCP (dynamic IP address) setting in the front panel operation, the Lightware Device Controller (LDC) and the LW3 programmer's reference section.

The following list contains all hashtag keywords placed in the document with a short description belonging to them. The list is in **alphabetical order** by the hashtag keywords.

Hashtag Keyword ↓	Description
#advancedview	Advanced view / Terminal window
#analogaudio	Analog audio related settings
#autoselect	Autoselect feature settings
#backup	Configuration cloning (backup)
#balance	Balance (for analog audio) setting
#builtinweb	Built-in miniweb
#buttonlock	Front panel button lock setting
#cablediagnostics	Cable diagnostics tool in LDC
#cec	CEC related settings
#commandinjection	RS-232 command injection settings
#configurationcloning	Configuration cloning (backup)
#crosspoint	Crosspoint switch setting
#devicelabel	Device label
#dhcp	Dynamic IP address (DHCP) setting
#diagnostic	Failure diagnostic related tool/information
#edid	EDID related settings

Hashtag Keyword ↓	Description
#eventmanager	Event manager
#factory	Factory default settings
#firmwareversion	Firmware version query
#framedetector	Frame detector in LDC
#gpio	GPIO-related settings
#hdcip	HDCP-encryption related setting
#identifyme	Identify me (identify the device) feature
#infra	Infrared port related settings
#infrared	Infrared port related settings
#ipaddress	IP address related settings
#label	Device label
#lock	Port lock setting
#lockbutton	Front panel button lock setting
#log	System log
#message	Message sending via communication ports
#miniweb	Built-in miniweb
#mute	Port mute setting
#network	Network (IP address) related settings
#nosyncscreen	Test pattern (no sync screen) settings
#portstatus	Source/destination port status query
#producttype	Product type query
#protocol	RS-232 protocol setting
#reboot	Restarting the device
#recognizer	RS-232 recognizer related settings
#restart	Restarting the device
#rs232	RS-232 related settings
#rs-232	RS-232 related settings
#rs232recognizer	RS-232 recognizer related settings
#rs-232recognizer	RS-232 recognizer related settings
#serial	RS-232 related settings
#serialnumber	Serial number query
#signaltype	HDMI/DVI signal type setting
#status	Status query

Hashtag Keyword ↓	Description
#switch	Crosspoint switch setting
#systemlog	System log
#terminal	Advanced view / Terminal window
#testpattern	Test pattern (no sync screen) settings
#tpsmode	TPS (HDBaseT) mode setting
#unlock	Port unlock setting
#unmute	Port unmute setting
#usb	USB 2.0 interface-related settings
#volume	Volume (for analog audio) setting
#web	Built-in miniweb

11.13. Further Information

Limited Warranty Statement

1. Lightware Visual Engineering LLC (Lightware) warrants to all trade and end user customers that any Lightware product purchased will be free from manufacturing defects in both material and workmanship for three (3) years from purchase unless stated otherwise below. The warranty period will begin on the latest possible date where proof of purchase/delivery can be provided by the customer. In the event that no proof can be provided (empty 'Date of purchase' field or a copy of invoice), the warranty period will begin from the point of delivery from Lightware.

1.1. 25G and MODEX product series will be subject to a seven (7) year warranty period under the same terms as outlined in this document.

1.2. If during the first three (3) months of purchase, the customer is unhappy with any aspect of a Lightware product, Lightware will accept a return for full credit.

1.3. Any product that fails in the first six (6) months of the warranty period will automatically be eligible for replacement and advanced replacement where available. Any replacements provided will be warranted for the remainder of the original unit's warranty period.

1.4. Product failures from six (6) months to the end of the warranty period will either be repaired or replaced at the discretion of Lightware. If Lightware chooses to replace the product then the replacement will be warranted for the remainder of the original unit's warranty period.

2. The above-stated warranty and procedures will not apply to any product that has been:

2.1. Modified, repaired or altered by anyone other than a certified Lightware engineer unless expressly agreed beforehand.

2.2. Used in any application other than that for which it was intended.

2.3. Subjected to any mechanical or electrical abuse or accidental damage.

2.4. Any costs incurred for repair/replacement of goods that fall into the above categories (2.1., 2.2., 2.3.) will be borne by the customer at a pre-agreed figure.

3. All products to be returned to Lightware require a return material authorization number (RMA) prior to shipment and this number must be clearly marked on the box. If an RMA number is not obtained or is not clearly marked on the box, Lightware will refuse the shipment.

3.1. The customer will be responsible for in-bound and Lightware will be responsible for out-bound shipping costs.

3.2. Newly repaired or replaced products will be warranted to the end of the originally purchased products warranty period.

Document Revision History

Rev.	Release date	Changes	Editor
1.0	14-02-2017	Initial version	Tamas Forgacs
2.0	01-12-2017	New document format, major updates for firmware v1.2.0, updated LDC and LW3 prog. ref. chapters	Tamas Forgacs
2.1	10-05-2018	Minor corrections	Tamas Forgacs
2.2	31-10-2018	1080p120 Hz signal support info added.	Laszlo Zsedenyi
2.3	06-06-2019	New features description of v1.3.4 firmware added (CEC, IR code sending, RS-232 recognizer), Update FW upgrade chapter (from LDU to LDU2), Release notes history added.	Judit Barsony, Laszlo Zsedenyi
3.0	16-07-2020	Document re-structured; MMX4x2-HDMI-USB20-L model added; optional accessories added.	Laszlo Zsedenyi

Contact Us

sales@lightware.com

+36 1 255 3800

support@lightware.com

+36 1 255 3810

Lightware Visual Engineering LLC.

Peterdy 15, Budapest H-1071, Hungary

www.lightware.com

©2020 Lightware Visual Engineering. All rights reserved. All trademarks mentioned are the property of their respective owners. Specifications subject to change without notice.